

UTILIS
multidec[®]
swiss type tools

GENERAL CATALOG 2020/21

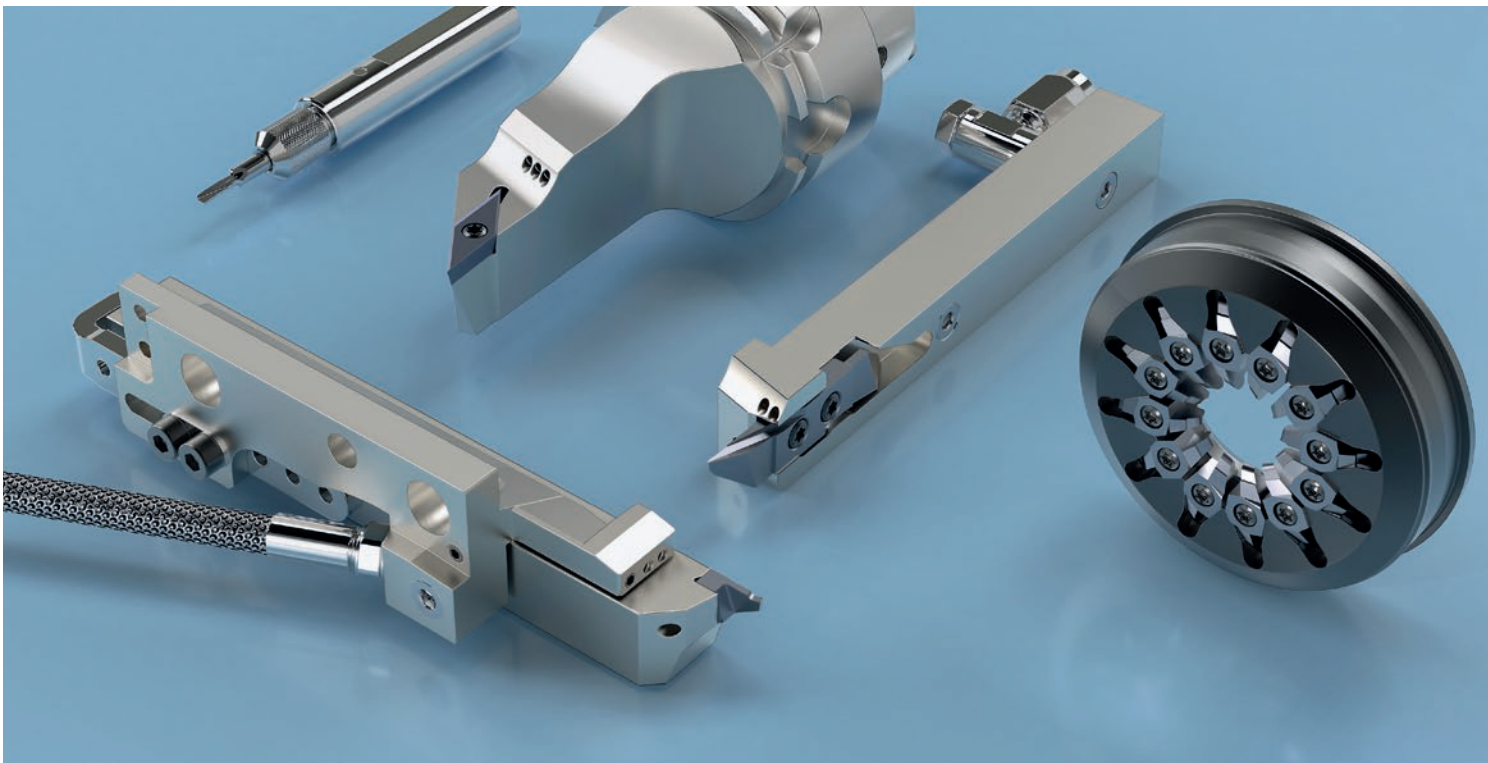

**PRECISION TOOLS
FOR SMALL PART MANUFACTURING AND MICRO-CUTTING**

future since
1915

UTILIS[®]
Tooling for High Technology

Welcome!

The UTILIS principle: We work hand in hand together with you. This allows us to know and understand what you need. And this knowledge is our driving force for the next "multidec® innovation".

For more than 25 years we have been developing outstanding precision tools under our own "multidec®" brand which are specifically designed to meet the challenges of the watch, medical and dental industries. We have now gone far beyond this, and also cover the automotive, aerospace and electronics industries, as well as many other areas.

Dear customers and partners, we are once again presenting our well-established products and also many new items and product extensions in the usual way in this new edition. Please don't hesitate to continue presenting us with your challenges, so that we can collaborate to find the best solution for you.

I am certain that we'll succeed in finding it!

On behalf of the entire team, I would like to thank you for your many years of loyalty and the many exciting and successful years to come.



We hope that our products and services bring you success and particularly enjoyment.

Yours Sincerely,
Your Mario, CEO

Ordering is simple and straightforward



Your customer service centre

Fon +41 52 762 62 62
Fax +41 52 762 62 00
orders@utilis.com



























The online shop – it couldn't be simpler!

www.utilis.com



Your contact

About UTILIS			4
Legend			8
Technical information			11
Indexable insert tools	multidec®-CUT		33
	multidec®-ISO		173
	multidec®-TOP		305
Solid carbide tools	multidec®-BORE MICRO		335
	multidec®-BROACH		369
	multidec®-DRILL		375
	multidec®-THREADMILL		381
	multidec®-GRAVER		395
Whirling tools	multidec®-WHIRLING		399
Tool systems ... 465	multidec®-SHORT		467
	multidec®-BACKTOOLS		475
	multidec®-MODULINE		517
	multidec®-KM™		529
	multidec®-HSK		537
	multidec®-PSC		549
	multidec®-MULTITASK		559
	multidec®-ESCOMATIC		583
	multidec®-TORNOS DECO		591
Special tools	multidec4you®		600
Accessories ... 603	multidec®-LUB		605
	Coolant system		619
	multidec®-TAPER-IN		643
	Screwdriver		651
	Collets / Reduction sleeves		654
Index of designations			656

PRECISION TOOLS FOR SMALL PART MANUFACTURING

multidec®-CUT 1600/3000



multidec®-CUT 1700



multidec®-ISO/-TOP



AND MICRO-CUTTING

multidec[®]-WHIRLING

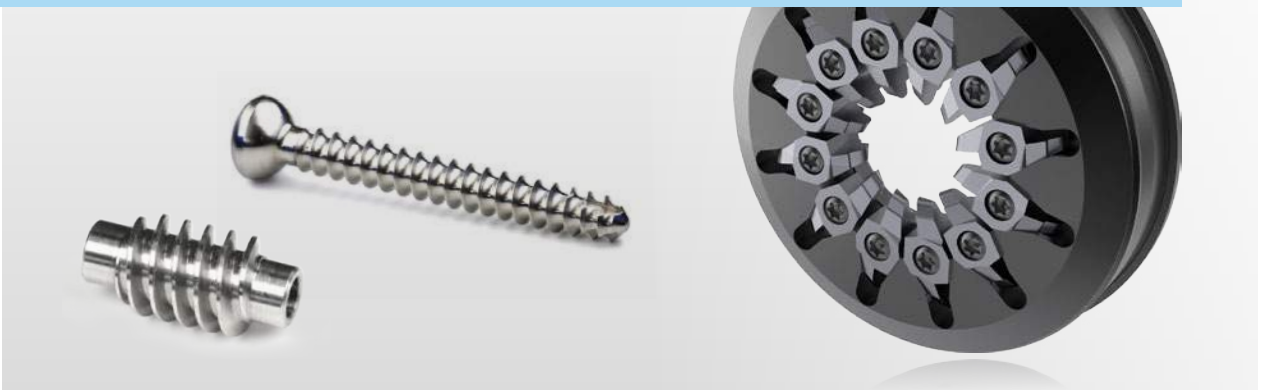

multidec[®]-BORE MICRO / -BROACH / -THREADMILL

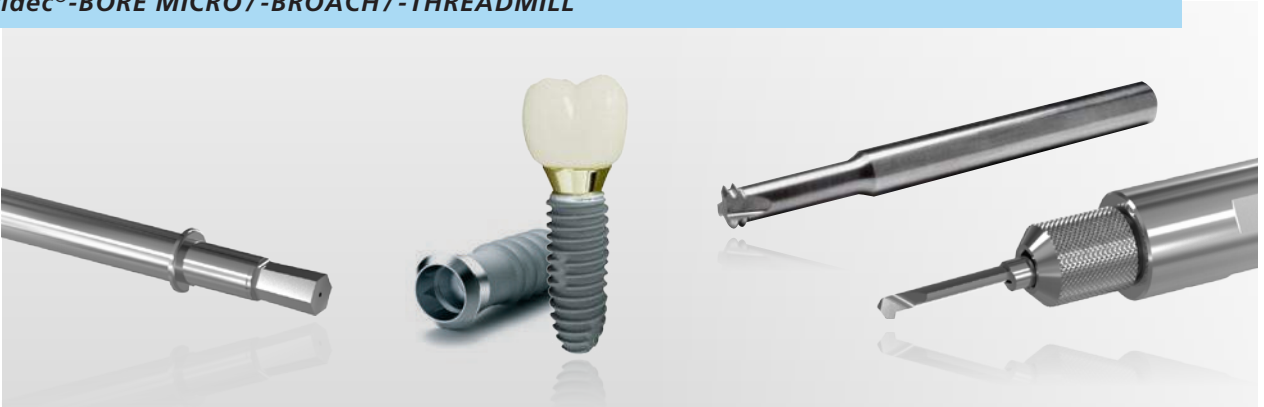

multidec[®]-MULTITASK



Future since 1915 – ideas change the world

UTILIS AG is one of the world's leading providers in the area of precision tools for micro-cutting—your partner for machining. We have been developing technologically leading solutions for more than 100 years, and provide you with top class technology in our products and services.

In the second half of the 19th century, in 1868 to be precise, the Ernst brothers founded a mechanical workshop in Müllheim. On November 9th 1915, this became a public limited company—the year in which UTILIS AG was born. From then on things proceeded step by step in a continuous and committed way.

Do you know what “UTILIS” stands for?

Utilitarian: “with regard to the benefits” or “utility-based” or “person who only focuses on the benefits”

Since the establishment of the company, our declared goal has been to develop and manufacture high-quality tools which provide our customers with a long-term benefit. We are not looking for short-term gain, but long-term value generation by means of market leadership and differentiation.

For us as a traditional, medium-sized Swiss family-run company, it is natural to make quality and customer proximity the highest priority. The products, technologies and services of UTILIS are something special.

Our claim: We provide you with products that set standards in all areas. We can only achieve this by our own researching, developing and manufacturing.

We have therefore taken the conscious decision to manufacture our “multidec®” own brand products in Switzerland. This puts us in a position to guarantee that all of our products fulfill the high UTILIS quality requirements.

In order to do this, in 2018 we set the course for the future with the completion of our extension building, among other things. This is the only way in which we can fulfill the high quality, precision and performance capability expectations of our customers.

We now have more than 80 employees at the Müllheim site, and are represented in more than 60 countries. This fills us with a great deal of pride, and compels and motivates us at the same time to always be a step ahead, also in the future.

INNOVATIONS IN THIS CATALOGUE

The revolutionary "TX+" coating

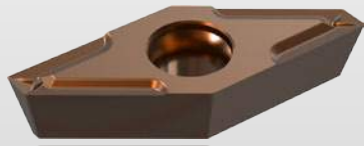

... for maximum productivity

... 122

Bigger choice of ISO inserts

... for even more flexibility



... 172

Lasered chip breaker "GS12"

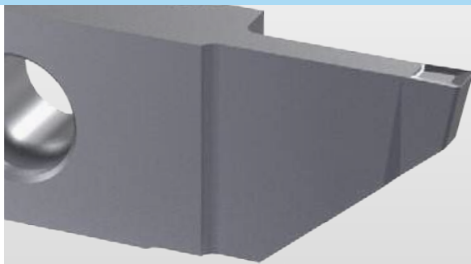

... for maximum chip control

Laser
GS12

... 109

Customer-specific special tools "multidec4you[®]"

... where standard tools approach the limits of their capability



... 600

Different information about multidec® application refer to certain machining methods. In addition, simple symbols inform of the product assortment and where additional products and technical information can be found.

Dimensions

All dimensions are in millimeter (mm); native dimensions in inch are calculated into millimeter.

Page information

□ 12... See page 12 and the following (example)

Recommended usage

- Preferred application
- Possible application
- Application not recommended

Availability

- Standard
- Semi-standard (by customer request)
- Standard New (in this catalog)
- Semi-standard (by customer request) New (in this catalog)
- discontinued

Important: The UHM30 carbide grade is being discontinued, and will be superseded by the new UHM20 grade.

Categorization of materials

The information on using multidec® tools refers to certain materials. The materials to be machined are categorized in the same color throughout the entire catalog:

Steel (non-alloyed, low alloyed and high alloyed)
Stainless steel
Titanium and Ti-alloys
Non-ferrous metals (gold, aluminum and brass)
Hard materials

Order designation

To the designation of the selected type of product, the desired cutting material code must be added. Supplementing information to the grades can be found according to the page references (□ ...).

Order designation		Carbide □ 20		
		○	●	●
		○	●	●
		○	●	●
		●	○	—
		—	—	○
L	R	UHM 20	UHM 20 HPX	UHM 20TX+
1605-0.5-1.5 L ...	1605-0.5-1.5 R ...	■	■	□
1605-1.0-2.5 L ...	1605-1.0-2.5 R ...	■	■	□
1605-1.5-3 L ...	1605-1.5-3 R ...	■	■	□

Example: 1605-0.5-1.5 L UHM 20

Legend

Packaging information

The product labels illustrate the content of the packaging and also show the materials on which the cutting insert can be used. For this purpose, UTILIS uses the ISO standard coding.

The UTILIS article number is generally also printed as a barcode on the UTILIS (multidec®) product packaging.

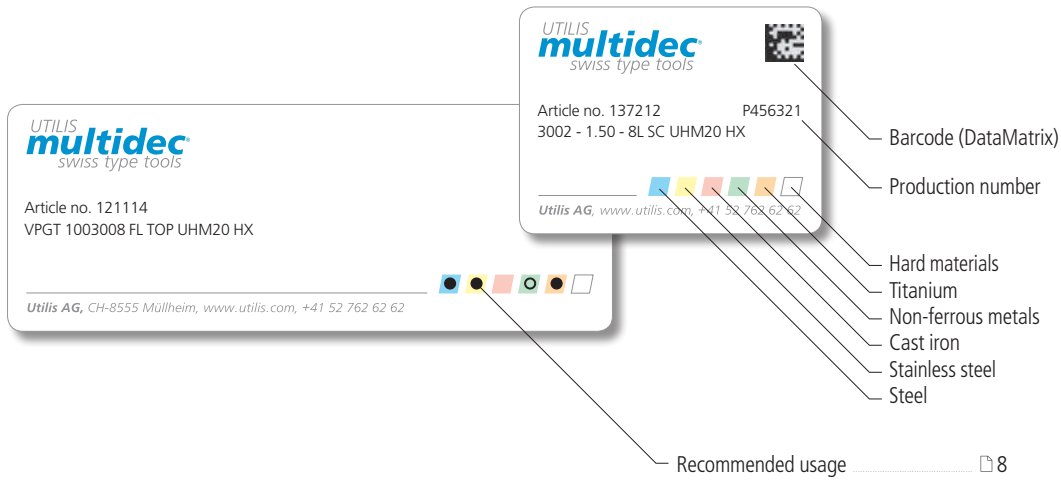

Execution of holder/insert

The side on which the insert is located determines whether it is a “left-” or “right-hand” holder. For this purpose, the holder is viewed with the insert pointing towards the observer.

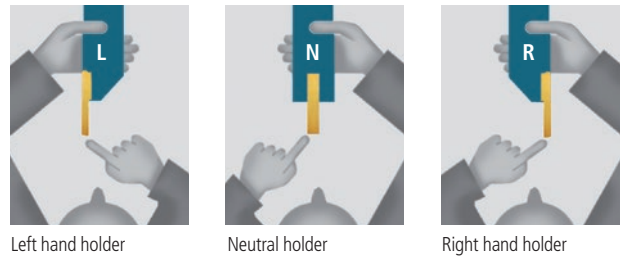

Pictures

The right-hand version of the tools is usually shown. (Exceptions are possible). The tool colours illustrated here are not binding.

Product lines

To meet today’s requirements of modern production it is not necessary to use the most accurate – but to use the tools adapted to the requirements. This means, the more accurate and sophisticated the process, the higher must be the accuracy of the produced tools. Therefore, the product range has been divided into three different accuracy classes. Your advantage: you buy the quality, which is effectively required.

Product line	Description
PREMIUM-LINE	The PREMIUM-LINE includes UTILIS tools with the highest accuracy requirements, especially for the production of micro parts. Tightest dimensional tolerances, precisely executed, highest surface quality and high repeatability are the features of this line. The manufacturing of these high-class tools requires considerable additional cost in production, which justifies the higher price of this product line.
STANDARD-LINE	The STANDARD-LINE meets the highest demands on the quality, which is demanded for Swiss type tools in production of small parts. Tight dimensional tolerances and high surface quality are implemented. These are quality standard tools, which are very well positioning this line in a wide range of applications.
VALUE-LINE	The VALUE-LINE is based on the known positions of our STANDARD-LINE. The most important functional elements – such as inserts and holders – are manufactured with the normal dimensional tolerances seen in the industry. Designed for the production of low-cost components, this line offers optimal quality standards. The greater tolerances and the reduced surface quality lower the production costs considerably, which also lowers the price in comparison to the standard product line.



A series of horizontal lines for taking notes, starting from the top of the page and extending down to the bottom.

Surface quality	12
Improvement of feed rate by drag-cut with TOP System	13
Categorization of materials	14
Properties and application range of carbide, cermet and HSS (High Speed Steel)	20
Properties and application range for diamond	21
Properties and application range of coatings	23
Comparison of default hardness values	23
Causes and remedies of wear	24
Problems and their remedies in different cases	25
Working situations	26
Designation system (ISO)	28
Formulas	31

For the definition of surface roughness measured values are defined by DIN-ISO. In particular it means:

- Single surface roughness depth $Z_1 \dots Z_5$
This is the vertical distance between the highest and the lowest point of the roughness profile R within a single measured length l_e .
- Average roughness depth R_z (DIN 4768)
This is defined as the average value resulting from the single roughness depths of five successive single measured lengths l_e .
- Average roughness value R_a (DIN 4768)
This is defined as the arithmetical mean of the absolute sums of the roughness profile R within the entire measured length l_m .
- Max. surface roughness depth R_t (DIN 4768/1)
This is the distance between the elevation and depression of the line within the measured length (reference distance) of profile filtered according to DIN 4768 sheet 1.

Average roughness value R_a

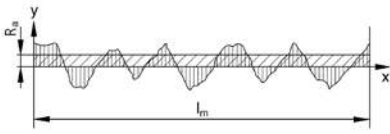

Single surface roughness depth Z

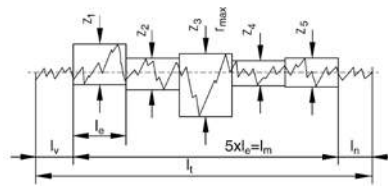

Maximum surface roughness R_t

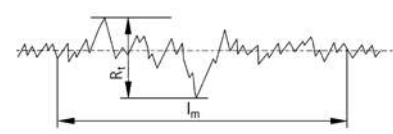

Surface roughness by machining method

Surface roughness	Micro finishing							Finishing			Roughing	
	0.025	0.05	0.1	0.2	0.4	0.8	1.6	3.2	6.3	12.5	25	50
Surface symbol according to ISO 1302	✓	✓	✓	✓	✓	✓	✓	✓	✓	✓	✓	✓
Roughness index (former)	N1	N2	N3	N4	N5	N6	N7	N8	N9	N10	N11	N12
Average roughness value R_a (µm)	0.025	0.05	0.1	0.2	0.4	0.8	1.6	3.2	6.3	12.5	25	50
Surface roughness depth R_z (µm)	0.025	0.63	1	1.6	2.5	4-6.3	10	16-25	40	63	100	160

Theoretical surface roughness

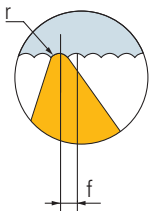

r = Corner radius (mm)
 R_t = Theoretical surface roughness (µm)
 f = Feed (mm)

Standard design

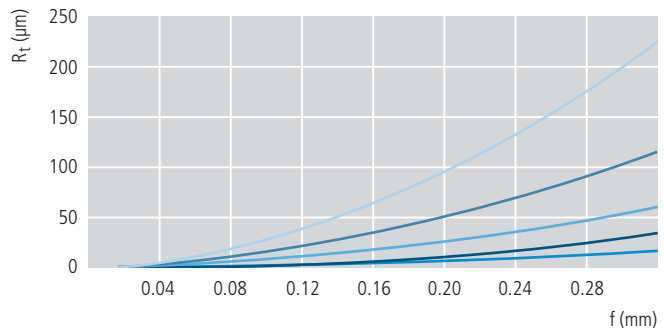

- $r = 0.05\text{mm}$ - $r = 0.10\text{mm}$ - $r = 0.20\text{mm}$ - $r = 0.40\text{mm}$ - $r = 0.80\text{mm}$

Improvement of feed rate by drag-cut with TOP System

By using the TOP system with drag-cut and a 93° holder the feed rate can be increased up to 2 times. This way the machining time can be decreased significantly by keeping the same quality. On the other hand within the same machining time the surface roughness can be improved clearly.

The following example illustrates the principle exactly.

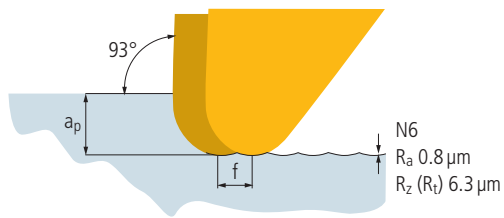

Holder 93°
Corner radius 0.8 mm

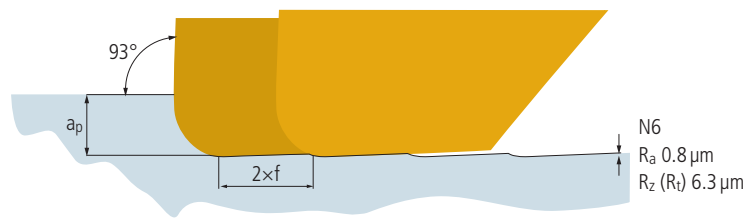

Holder 93°
Corner radius 0.8 mm
multidec®-TOP insert

Steel (non-alloyed, low alloyed and high alloyed)								
Category	Material number	Specifications					Market designation	Hardness (HB)
		DIN	ISO	AFNOR	AISI/SAE/ASTM	JIS		
I	1.0116	St37-3	–	E24-U, E24-3, E24-4	A573-81 65, A573 Gr. 58	–	–	125
I	1.0144	St44-3	–	E28-4	A573-81	–	–	125
I	1.0301	C 10	–	AF 34 C, XC 10	–	S 10 C	–	125–155
I	1.0401	C 15	–	C 18, AF3 7 C 12, XC 18, CC12	1015, 1016, 1017	S 15 C	–	98–178
I	1.0402	C 22	–	AF 42 C 20, 1 C 22, XC 25	1020, 1023	S 20 C, S 33 C	–	149–225
I	1.0501	C 35	–	C 35, 1 C 35, AF 55 C35, XC 38	1035	S 35 C, S 35 CM	–	178–225
I	1.0503	C 45	–	C 45, 1 C 45, AF 65 C 45	1045, 1043	S 45 C, S 45 CM	–	–
I	1.0535	C 55	–	C 54, 1 C 55, AF 70 C 55	1055	S 55 C, 1 C 55	–	–255
I	1.0570	St52-3, S355 J2G3 C	–	E 36-3, E 36-4	–	SM 50 YA	–	180
I	1.0601	C 60	–	C 60, 1 C 60, AF 70 C 55	1060	S 58 C	–	–255
I	1.0715	11 SMn 30, 9 SMn 28	11 SMn 28, 9 SMn 28	S 250	1213	SUM 22	–	107–169
I	1.0718	11 SMnPb 30, 9 SMnPb 28	11 SMnPb 28, 9 SMnPb 28	S 250 Pb	12 L 13	SUM 22 L, SUM 23 L, SUM 24 L	–	–
I	1.0721	10 S 20	–	10 F 1	1108	–	–	125–155
I	1.0722	10 SPb 20	–	10 PbF 2	11 L 08	–	–	–
I	1.0726	35 S 20	–	35 MF 6	1140	–	–	–
I	1.0727	46 S 20	–	–	–	–	–	178–214
I	1.0728	60 S 20	–	–	–	–	–	–
I	1.0736	11 SMn 37, 9 SMn 36	–	S 300	1215	SUM 25	–	–
I	1.0737	11 SMnPb 37, 9 SMnPb 36	11 SMnPb 35, 9 SMnPb 36	S 300 Pb	12 L 14	–	–	–
I	1.0756	35 SPb 20	–	–	–	–	–	–
I	1.0757	46 SPb 20	–	–	–	–	–	–
I	1.0758	60 SPb 20	–	–	–	–	–	–
I	1.0760	38 SMn 28	–	–	–	–	–	–
I	1.0761	38 SMnPb 28	–	–	–	–	–	–
I	1.0762	44 SMn 28, ETG 100	44 SMn 28	–	AISI 1144	–	–	320
I	1.0763	44 SMnPb 28	–	–	–	–	–	–
II	1.0904	55 Si 7	–	55 S 7	9255	–	–	235–290
II	1.0961	60 SiCr 7	–	60 SC 7	9262	SUP 7	–	245–310
I	1.1121	C 10 E, Ck 10	–	XC 10	–	S 10 C, S 9 CK	–	–
I	1.1141	C 15 E, Ck 15	–	XC 12, XC 15, XC 18	1015	S 15, S 15 CK	–	149–184
I	1.1157	40 Mn 4	–	35 M 5, 40 M 5	1039	–	–	–
I	1.1165	30 Mn 5	–	30 M 5	–	SMn 433 H, SCMn 2	–	238–280
I	1.1167	36 Mn 5, GS-36 Mn 5	–	35 M 5, 40 M 5	1335, 1541	SMn 438, SCMn 3	–	–217
I	1.1170	28 Mn 6	–	20 M 5, 28 Mn 6	1330	SCMn 1	–	223–255
I	1.1183	Cf 35	–	XC 38 H 1 TS	1035	S 35 C, S 35 CM	–	–
I	1.1191	C 45 E, Ck 45	–	C 45, 2 C 45, XC 42 H1, XC 45	1042, 1045	S 45 C, S 45 CM	–	207–255
I	1.1203	C 55 E, Ck 55	–	2 C 55, XC 55 H1, XC 54, XC 55	1055	S 55 C, S 55 CM	–	229–255
I	1.1213	Cf 53	–	XC 48 H 1 TS	1050, 1055	S 50 C, S 50 CM	–	–
I	1.1221	Ck 60	–	C 60, 2 C 60, XC 60	1064	S 58 C, S 60 CM, S 65 CM	–	241–255
I	1.1231	C 67 S, Ck 67	–	CX 68	–	S 70 CM	–	–92
I	1.1274	C 100 S, Ck 101	–	C 100, XC 100	1095	SUP 4, SK 4 CSP	–	–
I	1.1545	C 105 U, C 105 W 1	–	Y1 105	W 110	SK 3	–	190
I	1.1663	C 125 W	–	Y2 120	W 112	–	–	–
I	1.1730	C 45 W	–	–	–	–	–	–
II	1.2067	102 Cr 6, 100 Cr 6	–	Y 100 C 6	L 3	SUJ 2	–	–
III	1.2080	X 210 Cr 12	–	Z 200 C 12	D 3	SKD 1	–	–225
III	1.2083	X 42 Cr 13	–	Z 40 C 14	–	SUS 420 J 2	–	225
III	1.2210	115 CrV 3	–	100 C 3	L 2	–	–	–250
III	1.2311	40 CrMnMo 7	–	–	–	–	–	–235
III	1.2343	X 38 CrMoV 5-1	–	Z 38 CDV 5	H 11	SKD 6	–	–
III	1.2344	X 40 CrMoV 5-1	–	Z 40 CDV 5	H 13	SKD 61	–	–229
III	1.2355	50 CrMoV 13-15	–	–	–	–	–	–
III	1.2363	X 100 CrMoV 5-1	–	Z 100 CDV 5	A 2	SKD 12	–	–241

Steel (non-alloyed, low alloyed and high alloyed)

Category	Material number	Specifications					Market designation	Hardness (HB)
		DIN	ISO	AFNOR	AISI/SAE/ASTM	JIS		
III	1.2365	X 32 CrMoV 3 3	–	32 DCV 28	H 10	SKD 7	–	–
II	1.2379	X 155 CrV Mo 12 1	–	Z 160 CDV 12	D 2	SKD 11	–	–
II	1.2419	105 WCr 6	–	105 WCr 5, 105 Wc 13	–	SKS 2, SKS 3, SKS31	–	–
III	1.2436	X 210 CrW 12	–	Z 210 CW 12-01	–	–	–	-250
III	1.2510	100 MnCrW 4	–	90 MWCV 5	O 1	SKS 3	–	–
III	1.2516	120 WV 4	–	200 WC 20	F 1	–	–	–
II	1.2542	45 WCrV 7	–	45 WCrV 8, 45 WCV 20	S 1	–	–	–
III	1.2581	X 30 WCrV 9-3	–	Z 30 WCV 9	H 21	SKD 5	–	–
III	1.2601	X 165 CrMoV 12	–	–	H 12	–	–	–
II	1.2713	55 NiCrMoV 6	–	55 NCDV 7, 55 NCDV 7	L 6	SKT 4	–	–
III	1.2714	55 NiCrMoV 7	–	–	–	–	–	-350
III	1.2735	15 NiCr 14	–	10 NC 12	–	SNC 22	–	–
III	1.2738	40 CrMnNiMo 7	–	–	–	–	–	-350
II	1.3243	HS 6-5-2-5, S 6-5-2-5	–	Z 85 WDKCV 06-05-05-04-02	–	SKH 55	–	-269
II	1.3255	HS 18-1-2-5, S 18-1-2-5	–	Z 80 WKCV 18-05-04-01	T 4	SKH 3	–	-265
II	1.3343	HS 6-5-2, S 6-5-2	–	Z 85 WDCV 06-05-04-02	M 2	SKH 51	–	-280
II	1.3344	HS 6-5-3, S 6-5-3	–	Z 120 WDCV 06-05-01	M 3 Cl. 2, M 1	SKH 52, SKH 53	–	–
II	1.3346	HS 2-9-1, S 2-9-1	–	Z 85 DCWV 08-04-02-0	H 41, M 1	–	–	–
II	1.3348	HS 2-9-2, S 2-9-2	–	Z 100 DCWV 09-04-02-02	M 7	–	–	–
II	1.3355	HS 18-0-1, S 18-0-1	–	Z 80 WCV 18-04-01	T 1	SKH 2	–	-269
III	1.3505	100 Cr 6	–	–	52100	SUJ 2, SUJ 4	–	-207
II	1.5120	38 MnSi 4	–	–	–	–	–	–
II	1.5415	16 Mo 3, 15 Mo 3	–	15 D 3	A 204 Gr. A	STBA 12, STFA 12, STPA 12	–	–
II	1.5423	16 Mo 5	–	–	4419, 4520	SB 450 M, SB 480 M	–	–
II	1.5622	14 Ni 6	–	16 N 6	A 203	–	–	–
III	1.5680	X 12 Ni 5, 12 Ni 19	–	Z 18 N 5, 5 Ni, Z 10 N 05	2515, 2517	SL 5 N 590	–	–
II	1.5710	36 NiCr 6	–	–	3135	SNC 236	–	–
II	1.5732	14 NiCr 10	–	15 NC 11, 16 NC 11	3415	SNC 415, SNC 415 (H)	–	–
II	1.5736	36 NiCr 10	–	30 NC 11	–	SNC 631, SNC 631 (H)	–	–
II	1.5752	15 NiCr 13, 14 NiCr 14	–	12 NC 15, 14 NC 12, 13 NiCr 14	3310; 3312, 3316	SNC 815	–	-255
II	1.5755	31 NiCr 14	–	18 NC 13	–	SNC 836	–	–
II	1.6510	39 NiCrMo 3	–	–	–	–	–	-240
II	1.6511	36 CrNiMo 4, GS-36 CrNiMo4	–	35 NCD 5, 40 NCD 3	9840	SNCM 439	–	-250
II	1.6523	20 NiCrMo 2-2, 21 NiCrMo 2	–	20 NCD 2, 22 NCD 2	8615, 8617, 8620	SNCM 220, SNCM 220 (H)	–	-212
II	1.6546	40 NiCrMo 2-2	–	40 NCD 2	8640, 8740	SNCM 240	–	–
II	1.6580	30 CrNiMo 8	–	30 CND 8	–	SNCM 431	–	375-430
II	1.6582	34 CrNiMo 6, GS-34 CrNiMo 6	–	35 NCD 6	4337, 4340	SNCM 447	–	296-350
II	1.6587	18 CrNiMo7-6, 17 CrNiMo 6	–	18 NCD 6	–	–	–	159-207
II	1.6657	14 NiCrMo 13-4	–	16 NCD 13	9310	–	–	–
II	1.7015	15 Cr 3	–	12 C 3, 15 Cr 2, 18 C 3	5015	SCr 415	–	-174
II	1.7033	34 Cr 4	–	32 C 4, 34 Cr 4	5132	SCr 430	–	-255
II	1.7034	37 Cr 4	–	38 C 4	–	SCr 435 H	–	-255
II	1.7035	41 Cr 4	–	41 Cr 4, 42 C 4	5140	SCr 440	–	-255
II	1.7045	42 Cr 4	–	42 C 4 TS	5140	SCr 440	–	-255
II	1.7103	67 SiCr 5	–	67 SiCr 5	9254	–	–	–
II	1.7131	16 MnCr 5	–	16 MC 5, 16 MnCr 5	5115	–	–	-207
II	1.7139	16 MnCrS 5	–	16 MnCrS 5	5115	–	–	-207
II	1.7147	20 MnCr 5	–	20 MC 5	–	SMnC 420, SMnC 420 (H)	–	296-372
II	1.7176	55 Cr 3	–	55 C 3	5155	SUP 9	–	-280
II	1.7218	25 CrMo 4	–	25 CD 4	4130	SCM 420, SCM 430	–	-255
II	1.7220	34 CrMo 4	–	34 CD 4	4130, 4135, 4137	SCM 432, SCM 435 H, SCCrM 3	–	-255
II	1.7223	41 CrMo 4	–	42 CD 4 TS	4142	SNB 22, SCM 440	–	–
II	1.7225	42 CrMo 4	–	42 CD 4	4140, 4142	SCM 440, SNB 7	–	311-350
II	1.7228	50 CrMo 4	–	–	–	–	–	360-372
II	1.7262	15 CrMo 5	–	12 CD 4	–	SCM 415	–	–
II	1.7335	13 CrMo 4-5, 13 CrMo 4-4	–	15 CD 4.05	A 182-F11, F12	SFVA F 12, STBA 20, STBA 22	–	–
II	1.7361	32 CrMo 12	–	30 CD 12	–	–	–	–

Categorization of materials

16

Steel (non-alloyed, low alloyed and high alloyed)								
Category	Material number	Specifications					Market designation	Hardness (HB)
		DIN	ISO	AFNOR	AISI/SAE/ASTM	JIS		
II	1.7380	12 CrMo 9-10	–	12 CD 9-10, 10 CD 9-10	A 182-F22	SFVA F 22 A/B, SCM V 4, SCPH 32-CF	–	–
II	1.7715	14 MoV 6-3	–	14 Mo 6	K11591	–	–	–
II	1.8159	50 CrV 4	–	51 CV 4, 50 CV 4, 51 CrV 4	6150	SUP 10	–	–248
II	1.8161	58 CrV 4	–	–	–	–	–	–255
II	1.8507	34 CrAlMo 5	–	30 CAD 6-12	–	–	–	–
II	1.8509	41 CrAlMo 7-10	–	40 CAD 6-12	E 7140	SACM 1, SACM 645	–	–255
II	1.8519	31 CrMoC 9	–	–	–	–	–	–248
II	1.8522	33 CrMoV 12-9	–	–	–	–	Nitrodur 8522	–
II	1.8523	40 CrMoV 13-9, 39 CrMoV 13-9	–	–	–	–	–	–

Stainless steel								
Category	Material number	Specifications					Market designation	Hardness (HB)
		DIN	ISO	AFNOR	AISI/SAE/ASTM	JIS		
V	1.4000	X 6 Cr 13	–	Z 8 C 12, Z 6 C 13	403	SUS 403	–	–200
V	1.4001	X 7 Cr 14	–	Z 8 C 13 FF	410 S	SUS 410 S	–	130–180
V	1.4002	X 6 CrAl 13	–	Z 6 CA 13	405	SUS 405	–	130–180
V	1.4005	X 12 CrS 13	–	X 12 CrS 13	416	SUS 416	–	–220
V	1.4006	X 12 Cr 13	–	Z 10 C 13	410, CA-15	SUS 410	–	–220
VI	1.4016	X 6 Cr 17	–	Z 8 C 17	430	SUS 430	–	240
VI	1.4021	X 20 Cr 13	–	–	–	–	–	–230
VI	1.4027	GX 20 Cr 14	–	Z 20 C 13 M	–	SCS 2	–	170–240
VI	1.4028	X 30 Cr 13	–	–	–	–	–	–245
VI	1.4034	X 46 Cr 13	–	Z 44 C 14	420	SUS 420	–	–245
VI	1.4035	X 45 CrS 13	–	–	420 F	SUS 420 F	–	–245
VI	1.4057	X 17 CrNi 16-2	–	Z 15 CN 16-02	431	SUS 431	–	–295
V	1.4104	X 12 CrMoS 17	–	Z 10 CF 17	430 F	SUS 430 F	–	–220
V	1.4105	X 6 CrMoS 17, X 4 CrMoS 18	–	Z 8 CF 17	430 FR	–	–	–200
VI	1.4108	X 30 CrMoN 15-1	–	–	5898	–	–	200–240
VI	1.4109	X 70 CrMo 15, X 65 CrMo 14	–	–	440 A	–	–	–280
V	1.4112	X 90 CrMoV 18	–	X 90 CrMoV 18	440 B	SUS 44 B	–	–255
V	1.4113	X 6 CrMo 17-1	–	Z 8 CD 17-01	434	SUS 434	–	–200
VI	1.4123	X 40 CrMoVN 16-2	–	Z 40 CDV 16-02	420 Mod	–	–	–265
V	1.4125	X 105 CrMo 17	–	Z 100 CD 17	440 C	SUS 440 C	–	–255
V	1.4197	X 20 CrNiMoS 13-1	–	–	420F Mod	–	–	–220
V	1.4301	X 5 CrNi 18-10	–	Z 6 CN 18-10	304, 304 H	SUS 304	–	–215
V	1.4305	X 8 CrNiS 18-9	X 10 CrNiS 18-9	Z 8 CNF 18-09	303	SUS 303	–	–230
V	1.4306	X 2 CrNi 19-11, X 2 CrNi 18-11	X 2 CrNi 19-11	Z 3 CN 19-11, Z 2 CN 18-10	304 L	SUS 304 L, SCS 19	–	–215
V	1.4308	X 6 CrNi 18-9	–	Z 6 CN 18-10 M	CF-8	SCS 13	–	130–200
V	1.4310	X 10 CrNi 18-8, X 12 CrNi 17-7	X 10 CrNi 19-8	Z 11 CN 18-08, Z 12 CN 18-09	301, 302	SUS 301	–	–
V	1.4311	X 2 CrNiN 18-10	–	Z 3 CN 18-10 Az	304 LN	SUS 304 LN	–	–230
VI	1.4313	X 3 CrNi 13-4	–	Z 4 CND 13-4, Z 6 CN 13-4	CA 6-NM	SCS 5	–	–320
VI	1.4317	GX 4 CrNi 13-4	–	Z 8 CD 17-1	CA 6-NM	SCS 6	–	230–350
V	1.4401	X 5 CrNiMo 18-10, X 5 CrNiMo 17-12-2	–	Z 6 CND 17-11, Z 6 CND 17-12-02	316	SUS 316	–	–215
V	1.4404	X 2 CrNiMo 17-12-2+S+Cu, X 2 CrNiMo 17-12-2	–	Z3CND17-11-02	316 L	SUS 316 F	–	–215
V	1.4408	X 6 CrNiMo 18-10	–	–	CF-8M	SCS 14	–	130–200
V	1.4410	X 2 CrNiMoN 25-7-4	–	Z 2 CND 25-07-04 Az	F53	–	–	–230
V	1.4427	X 12 CrNiMoS 18-11	–	–	316 L	SUS 316 F	–	–
VI	1.4429	X 2 CrNiMoN 17-13-3, X 2 CrNiMoN 17-11-2	–	Z 2 CND 17-13 Az, Z 3 CND 17-11-03 Az	316 LN	SUS 316 LN	–	–250
V	1.4435	X 2 CrNiMo 18-14-3	–	Z 3 CND 18-14-03	316L	SUS 316 L, SCS 16	–	–215

Stainless steel

Category	Material number	Specifications					Market designation	Hardness (HB)
		DIN	ISO	AFNOR	AISI/SAE/ASTM	JIS		
V	1.4436	X 5 CrNiMo 17-13-3	–	Z 6 CND 18-12-03	316	SUS 316	–	–215
V	1.4438	X 2 CrNiMo 18-15-4	–	Z 2 CND 19-15-04	317L	SUS 317L	–	–215
V	1.4441	X 2 CrNiMo 18-15-3	5832-1	–	316 LVM, F 138	SUS 316	–	–
V	1.4452	X 13 CrMnMoN 18-14-3	–	–	–	–	–	–
VI	1.4460	X 3 CrNiMo 27-5-2, X 8 CrNiMo 27-5	–	Z 5 CND 27-05 Az	329	SUS 329 J 1, SCS 11, SCH 11	–	–260
VI	1.4462	X 2 CrNiMoN 22-5-3	–	Z 2 CND 22-05-03 AZ	329 A	–	Uranus 45 N	–270
V	1.4501	X 2 CrNiMoCuWN 25-7-4	–	Z 2 CNDUW 25-07-04 AZ	F55	–	Zeron 100	–230
VI	1.4507	X 2 CrNiMoCuN 25-6-3	–	Z 3 CNDU 25-07 AZ	F61	–	Uranus 52 N	–185
V	1.4510	X 6 CrTi 17, X 3 CrTi 17	–	Z 8 CT 17	XM 8, 430 Ti	SUS 430 LX	–	–185
V	1.4512	X 5 CrTi 12, X 2 CrTi 12	–	Z 6 CT 12	409	SUH 409	–	–180
VI	1.4539	X 1 NiCrMoCu 25-20-5	–	Z 2 NCDU 25-20	904 L	–	Uranus B6	–230
VI	1.4541	X 6 CrNiTi 18-10	–	Z 6 CNT 18-10	321	SUS 321	–	–215
VI	1.4542	X 5 CrNiCuNb 16-4, X 7 CrNiCu 16-4-4	–	Z 7 CNU 17-04-04	630, 17-4 PH	SCS 24, SUS 630	–	–360
VI	1.4543	X 3 CrNiCuTiNb 12-9	–	–	XM-16	–	–	–
VI	1.4547	X 1 CrNiMoCuN 20-18-17	–	Z 1 CNDU 20-18-06 AZ	F44	–	–	–250
VI	1.4548	X 5 CrNiCuNb 17-4-4	–	–	–	–	–	–360
VI	1.4550	X 6 CrNiNb 18-10	–	Z 6 CNNb 18-10	347, 348	SUS 347	–	–230
V	1.4568	X 7 CrNiAl 17-7	–	–	17-7 PH	–	–	–230
V	1.4570	X 6 CrNiCuS 18-9-2	–	–	–	–	–	–215
V	1.4571	X 6 CrNiMoTi 17-12-2	–	Z 6 CNDT 17-12	316 Ti	SUS 316 Ti	–	–215
V	1.4581	GX 5 CrNiMoNb 19-11-2	–	Z 4 CNDNb 18-12 M	–	SCS 22	–	130–200
V	1.4583	X 10 CrNiMoNb 18-12	–	–	318	–	–	130–220
VI	1.4718	X 45 CrSi 9-3	–	Z 45 CS 9	HNV 3	SUH 1	Pyrodur 4718	–300
V	1.4724	X 10 CrAl 13, X 10 CrAlSi 13	–	Z 13 C 13	405	SUS 405	–	–192
V	1.4742	X 10 CrAl 18, X 10 CrSiAl 18-1-1	–	Z 10 CAS 18	430	SUH 21, SUS 430	–	–212
VI	1.4757	X 80 CrNiSi 20	–	–	HNV6	SUH 4	–	–
V	1.4762	X 10 CrAl 24, X 10 CrAlSi 25	–	Z 12 CAS 25	446	SUH 446	–	–223
V	1.4828	X 15 CrNiSi 20-12	–	Z 9 CN 24-13, Z 17 CNS 20-12	309	SUH 309	–	–223
V	1.4841	X 15 CrNiSi 25-20	–	Z 15 CNS 25-20	314	–	–	165–225
VI	1.4845	X 8 CrNi 25-21, X 12 CrNi 25-21	–	Z 8 CN 25-20, Z 12 CN 25-20	310 S	SUH 310, SUS 310 S	–	–
VI	1.4864	X 12 NiCrSi 35-16, X 12 NiCrSi 36-16	–	Z 20 NCS 33-16	330	SUH 330	–	–
VI	1.4865	GX 40 NiCrSi 38-19, GX 40 NiCrSi 38-18	–	–	–	SCH 15, SCH 16	–	–
V	1.4871	X 53 CrMnNiN 21-9	–	Z 52 CMN 21-09 Az	EV 8	SUH 35, SUH 36	–	–
V	1.4876	X 10 NiAlTi 32-21, X 10 NiCrAlTi 32-21	–	–	314	–	MICROFER® 3220 h	135–205
V	1.4878	X 12 CrNiTi 18-9, X 8 CrNiTi 18-10	–	Z 6 CNT 18-10	321	SUS 321	–	215
VI	1.4923	X 20 CrMoV 12-1, X 22 CrMoV 12-1	–	–	–	–	–	–270
V	1.4944	X 6 NiCrTiMoV 26-15	–	–	660	–	–	–200
VI	1.4980	X 6 NiCrTiMoVB 25-15 2	–	–	453	–	INCOLOY® Alloy A-286	248–341
VI	1.6359	X 2 NiCoMo 18-8-5	–	–	–	–	MARVAL 18	–
VI	2.4068	Nickel 201	–	UNS N02201	–	–	–	–
VI	2.4668	NiCr19Fe18Nb5Mo3 Ti1AlC	–	–	–	–	INCONEL® Alloy 718	> 352
VI	2.4711	CoCr20Ni15Mo7	–	K13C20N16Fe15D7	F1058	–	Phynox® KL	–
VI	Co Cr	Co Cr	–	–	–	–	–	–

Categorization of materials

18

Titanium and Ti-alloys								
Category	Material number	Specifications					Market designation	Hardness (HB)
		DIN	ISO	AFNOR	AISI/SAE/ASTM	JIS		
IV	3.7025	TiCP Grade 1	5832-2	T35	B 348, F67	KS-40	–	~120
IV	3.7035	TiCP Grade 2	5832-2	T40	B 348/265, F 67	KS-50	–	~150
IV	3.7034	TiCP Grade 2	5832-2	T40	B 348/265, F 67	KS-50	–	~150
IV	3.7055	Ti 3 (Grade 3)	5832-2	T50	F67	KS-70	–	~170
IV	3.7064	TiCP Grade 4, TiCP Grade 4B	5832-2	T60	B 348, F 67, B265	KS-85	–	~200
IV	3.7065	TiCP Grade 4B, TiCP Grade 4	5832-2	–	B 348, F 67	KS-85	–	~200
IV	3.7115	Ti Al 2.5 5n (Grade 6)	–	–	B 348/TA 5E	KS-115 AS	–	–
IV	3.7134	TiCu 2	–	–	B 348, F 67	–	–	<260
IV	3.7164	Ti6AlV4 Grade 5, TiAl 8 Mo 1 V 1	5832-3	TA6V	B265, B348, 4911, 4928	KS-130 AV	–	~310
IV	3.7165	Ti6AlV4 Grade 5	5832-3	TA6V	B265, B348, 4911, 4928	KS-130 AV	–	~310
IV	3.7235	Ti 2 Pd (Grade 7)	–	–	B 348/F 67	–	–	~150
IV	3.7154	TiAl 6 Zr 5	–	–	B 348	KS-50 Pd	–	–
IV	3.7194	Ti 3 Al 2.5V (Grade 9)	–	–	B 348	KS-50 Pd	–	–
IV	3.7225	Ti 7 (Grade 7)	–	–	–	–	–	~150
IV	9.9367	TiAl6Nb7	5832-11	TA6Nb7	F1295	–	Protasul	–

Non-ferrous metals (aluminum)								
Category	Material number	Specifications					Market designation	Hardness (HB)
		DIN	ISO	AFNOR	AISI/SAE/ASTM	JIS		
VII	2.1871	G-AlCu 4 TiMg	–	–	–	–	–	–
VII	3.0205	Al99	–	1200 (A4)	–	–	–	–
VII	3.0255	Al99.5	–	1050 A	1000	–	–	–
VII	3.0275	Al99.7	–	1070 A	–	–	–	–
VII	3.0285	Al99.8	–	1080 A	–	–	–	–
VII	3.1255	AlCuSiMn	–	–	2014	–	AVIONAL 14	–
VII	3.1325	AlCuMg 1	–	2017 A (AU4G)	–	–	AVIONAL 17	–
VII	3.1355	AlCuMg 2	–	2024 (AU4G1)	–	–	AVIONAL 24	–
VII	3.1645	AlCuMgPb	–	2030 (AU4Pb)	–	–	–	–
VII	3.1655	AlCuBiPb, AlCu 6 BiPb	–	2001 (AU5PbBi)	–	–	–	–
VII	3.1754	G-AlCu 5 Ni 1.5	–	–	–	–	–	–
VII	3.2163	G-AlSi 9 Cu 3	–	–	–	–	–	–
VII	3.2315	AlMgSi 1	–	–	6082	–	ANTICORODAL 100	–
VII	3.2371	G-AlSi 7 Mg	–	–	4218 B	–	–	–
VII	3.2373	G-AlSi 9 Mg	–	–	–	–	–	–
VII	3.2381	G-AlSi 10 Mg	–	–	–	–	–	–
VII	3.2382	GD-AlSi 10 Mg	–	–	–	–	–	–
VII	3.2383	G-AlSi 10 Mg (Cu)	–	–	A 360.2	–	–	–
VII	3.2581	G-AlSi 12	–	–	A 413.2	–	–	–
VII	3.2582	GD-AlSi 12	–	–	A 413.0	–	–	–
VII	3.2583	G-AlSi 12 (Cu)	–	–	A 413.1	–	–	–
VII	3.3206	AlMgSi 0.5	–	6060 (AGS)	6063	–	ANTICORODAL 63 - AL6060	–
VII	3.3207	E-AlMgSi 0.5	–	–	6101	–	ALDREY	–
VII	3.3214	AlMgSi 0.5	–	–	6061	–	ANTICORODAL 61	–
VII	3.3315	AlMg 1	–	5005 (AlMg1)	–	–	–	–
VII	3.3545	AlMg 4 Mn	–	5086 (AG4MC)	5083	–	PERALUMAN 44	–
VII	3.3547	AlMg 4.5 Mn 0.7	–	5083 (AlMg5Mn0.7)	5083	A 5083	–	–
VII	3.3561	G-AlMg 5	–	–	–	–	–	–
VII	3.4335	AlZn 4.5 Mg 1	–	7020 (AZ5G)	7020	–	CARPENTAL	–
VII	3.4345	AlZnMgCu 0.5	–	–	7050	–	–	–
VII	3.4365	AlZnMgCu 1.5	–	7075 (AZ5GU)	7075	–	ERGAL	–
VII	3.5101	G-MgZn 4 SE 1 Zr 1	–	–	ZE 41	–	–	–
VII	3.5103	MgSE 3 Zn 2 Zr 1	–	–	EZ 33	–	–	–
VII	3.5106	G-MgAg 3 SE 2 Zr 1	–	–	QE 22	–	–	–
VII	3.5812	G-MgAl 8 Zn 1	–	–	AZ 81	–	–	–
VII	3.5912	G-MgAl 9 Zn 1	–	–	AZ 91	–	–	–

Non-ferrous metals (brass)

Category	Material number	Specifications					Market designation	Hardness (HB)
		DIN	ISO	AFNOR	AISI/SAE/ASTM	JIS		
VIII	2.0220	CuZn 5	–	–	C 21000	C2100	–	65–110
VIII	2.0230	CuZn 10	–	–	–	–	–	75–130
VIII	2.0240	CuZn 15	–	–	–	–	–	65–145
VIII	2.0250	CuZn 20	–	–	–	–	–	65–150
VIII	2.0265	CuZn 30	–	–	C 26000	C2600	–	70–165
VIII	2.0321	CuZn 37	–	–	C 27200, C 27400	C2700, C2720	–	70–180
VIII	2.0331	CuZn 35 Pb 1, CuZn 36 Pb 1.5	CuZn 35 Pb 1	–	C 34000, C 34700	C3501	–	95–120
VIII	2.0335	CuZn 36	CuZn 37	–	C 27000, C 27200	C2700	–	65–130
VIII	2.0360	CuZn 40	–	–	–	–	–	95–120
VIII	2.0371	CuZn 38 Pb 2, CuZn 38 Pb 1.5	CuZn 38 Pb 2	–	C 37700	C3771, C3561	–	80–160
VIII	2.0375	CuZn 36 Pb 3	–	–	–	–	–	80–155
VIII	2.0380	CuZn 39 Pb 2	CuZn 38 Pb 2	–	C 37700	C3771, C3561	–	95–150
VIII	2.0401	CuZn 39 Pb 3	CuZn 38 Pb 3	–	C 38500	C3603	–	80–145
VIII	2.0402	CuZn 40 Pb 2	CuZn 40 Pb 2	–	C 38000	C3771, C3561	–	80–145
VIII	2.0410	CuZn 44 Pb 2	–	–	–	–	–	–
VIII	2.0490	CuZn 31 Si	CuZn 31 Si 1	–	C 69800	–	–	<180
VIII	2.0540	CuZn 35 Ni	–	–	–	–	–	–
VIII	2.0550	CuZn 40 Al 2, CuZn 37 Mn 3 Al 2 PbSi	CuZn 37 Mn 3 Al 2 Si	–	C 67400	–	–	130–200
VIII	2.0572	CuZn 40 Mn 2 Fe 1	–	–	–	–	–	–
VIII	2.0771	CuNi 7 Zn 39 Mn 5 Pb 3	–	–	–	–	–	130–200
VIII	2.0853	CuNi 1 Si	–	–	C 19010	–	–	–170
VIII	2.1191	CuAg 0.1, CuAg0.10P	–	–	C 10700, C 12100	–	–	–120
VIII	2.1293	CuCr 1 Zr	–	–	C 18150	–	–	–170
VIII	2.1310	CuFe 2 P	–	–	C 19400	–	–	–170
VIII	2.1498	CuSP, CuS (P0.01)	–	–	C 14700	–	–	–140

Non-ferrous metals (Synthetics reinforced/composites)

Category	Material number	Specifications					Market designation	Hardness (HB)
		DIN	ISO	AFNOR	AISI/SAE/ASTM	JIS		
IX	Glass-fibre reinforced plastics (GRP)							
IX	Carbon-fibre reinforced plastics (CRP)							

Hard materials

Category	Material number	Specifications					Market designation	Hardness (HRC)
		DIN	ISO	AFNOR	AISI/SAE/ASTM	JIS		
X	Hardened steels							
X	1.3334	HS 6-5-2 C		Z 85 WDCV 6	M 2 reg. C		HSS	–66
X							Hardox 400	45
X							Hardox 500	55

Properties and application range of carbide, cermet and HSS

20



Grade	Norm	Application range															Materials (category) and hardness value (HB)/HRC									
		DIN/ISO 513															125-300	180-250	200-350	180-220	220-330	Titanium (IV)	60-130	Brass (VII)	Synthetics reinforced/composites (X)	45-70 HRC
		1	5	10	15	20	25	30	35	40	45	50	Steel non-alloyed (I)	Steel low alloyed (II)	Steel high alloyed (III)	Stainless steel (V)	Stainless steel (VI)	Aluminum (VII)	Brass (VII)	Synthetics reinforced/composites (X)	Hard materials (X)					
Carbide																										
UHM 10	K 10/N 10/S 10																									
UHM 10 HX	K 10/N 10/S 10																									
UHM 10 TX+	P 10/M 10/S 10/H 10																									
UHM 10 MZ	P 15																									
UHM 20	N 20																									
UHM 20 HPX	P 20-40/M 20-40/S 20-40																									
UHM 20 HX	P 20/M 20/S 20																									
UHM 20 TX+	P 20/M 20/S 20/H 20																									
UHM 20 MZ	P 25/M 20																									
UHM 30	P 30/S 30/M 20/N 20																									
UHM 30 HX	P 25/M 25/S 25/N 25																									
UHM 30 TX+	P 25/M 25/S 25																									
UHM 30 MZ	P 35/M 30																									
UHM 30 SX	P 35/M 30/N 30																									
Cermet																										
UCM 10	P 15/M 10																									
UCM 10 HX	P 10/M 10																									
HSS																										
HSS	P 40-50/M 40-50/N 40-50																									
HSS HX	P 40-50/M 40-50/N 40-50																									

Application range for diamond 21...

Legend 8...

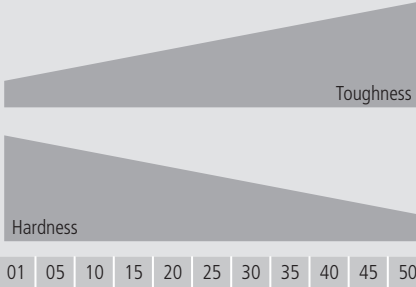
Grade	Norm	Application range	Materials (category) and hardness value (HB) / (HRC)									
		DIN/ISO 513	125–300	180–250	200–350	180–220	220–330		60–130			45–70 HRC
			Steel non-alloyed (I)	Steel low alloyed (II)	Steel high alloyed (III)	Stainless steel (V)	Stainless steel (VI)	Titanium (IV)	Aluminum (VII)	Brass (VIII)	Synthetics reinforced/composites (IX)	Hard materials (X)
		01 05 10 15 20 25 30 35 40 45 50										
Diamond												
UCVD 08			-	-	-	-	-	-	●	●	●	-
UPCD 15			-	-	-	-	-	-	●	●	-	-
UPCD 20			-	-	-	-	-	-	●	●	○	-

The exceptional hardness of diamonds in the various tool versions enables much higher cutting parameters to be achieved compared when conventional cutting materials are used.

In addition to traditional grinding and erosion machining, the use of high tech lasers not only produces top quality cutting edges, but also enables 3D chip removal geometries to be obtained.

UPCD15 / UPCD20

UPCD (polycrystalline diamond) is a sintered diamond powder in a metallic bonding matrix. Its grain structure ranging from ultra-fine (UPCD20) to coarse (UPCD15) gives the UPCD varying degrees of toughness, so greatly extending the range of possible applications.

With its diamond content of around 90 % only, UPCD has a much lower hardness and hence wear-resistance than UCVD.

Suitable for the following materials:

- Aluminum with 8–20 % SiC
- Brass, copper and bronze
- Platinum and gold

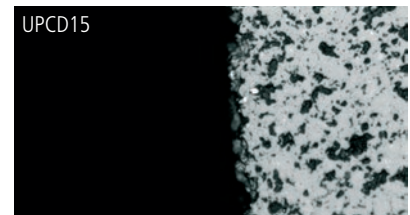

UCVD08

This diamond is produced by the CVD technique with a thickness of 0.8 mm. No binder is used. Minute diamond crystals are separated from the gas phase into a thick polymer diamond substrate which consists of up to 99.9 % diamond material.

Because of its high wear resistance, the life time of this innovative cutting material is between 2 and 10 times longer than that of UPCD.

The extremely sharp cutting edge enables reduced cutting pressure to be applied, therefore achieving excellent surface quality.

Suitable for the following materials:

- CFK... up to 80 % carbon fiber
- GFK... up to 80 % glass fiber
- Plastics
- Aluminum with 8–20 % SiC
- Brass, copper and bronze
- Platinum and gold



Properties and application range of coatings

22

UTILIS coating code	Coating	Materials (Category)										Characteristics
		(I)	(II)	(III)	(V)	(VI)	(IV)	(VII)	(VIII)	(IX)	(X)	
		Steel non-alloyed	Steel low alloyed	Steel high alloyed	Stainless steel	Stainless steel	Titanium	Aluminium	Brass	Synthetics reinforced/composites	Hard materials	
Standard for general applications												
HX	TiAIN / AlTiN	●	●	●	●	●	●	●	●	○	-	Standard allround coating for finishing and micro-finishing operations on a wide range of materials.
HPX	TiAIN / AlTiN	●	●	●	●	●	●	○	○	○	-	
MZ	TiN / TiAIN	●	●	●	●	●	-	-	-	-	-	
INNOVATION	TX+	TiSiN	-	○	●	●	●	-	-	-	●	High-performance coating for micro finishing and finishing operations in steel, stainless steel and highly heat resistant materials as well as micro cutting of hardened steels up to 70 HRC.
		<p>A new coating technology gave rise to this high-performance hard material coating. This coating is characterised by its extremely smooth, defect-free finish and the extreme hardness and adhesion. Its even, micro-accurate and thin coating provides maximum cutting edge quality, even with the smallest tools. It counteracts the formation of built-up edges during deployment, and provides improved chip flow. The surface quality and the tool life increase significantly. This coating has now been introduced as the standard coating in all multidec® product lines.</p>										
General applications (upon customer request)												
SX	TiN	●	●	○	○	○	-	○	○	-	-	Coating for the machining of steel materials for slow and medium cutting speeds. Not recommended for highly heat resistant materials.
BX	TiCN	●	●	○	●	○	○	-	-	-	-	Coating with extreme hardness and outstanding toughness. Extremely suitable for steel, stainless steel and conditionally for titanium, at slow cutting speeds.
HX-A	AlCrN	●	●	●	●	●	○	-	-	-	-	Universally usable coating for dry and wet machining at fast cutting speeds in steel and stainless steel.
Special applications (upon customer request)												
HX-F	AlCrN	●	●	●	●	●	○	-	-	-	-	High-performance coating for micro finishing operations in steel and stainless steel. Recommended for sharp edges, which are used in micro machining.
DX-T	Diamond DLC	-	-	-	-	-	-	●	●	○	-	Diamond coating for non-ferrous metals. Recommended for aluminium, plastic, brass and copper.
DX-HC	Diamond Ta-C	-	-	-	-	-	-	●	●	●	-	High performance diamond coating for non-ferrous metals. Recommended for aluminium alloys, platinum, silver, gold, composites and reinforced synthetics

Properties and application range of coatings

With the refinement of cutting tools with an additional coating the wear will be decisively reduced. Rubbing, warming up, diffusion and oxidation decreases significantly.

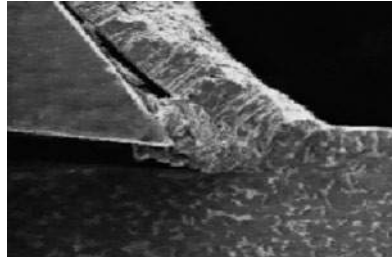

Cutting process without coated tool

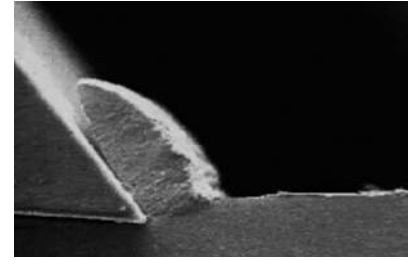

Cutting process with coated tool

Rounded edges among coated inserts

Every coating of a carbide insert results in rounded cutting edge. The smaller the diameter of the material to be cut, the more significant are the consequences in the cutting performance. Therefore the rounding off of the cutting edge depends on the thickness of the coated layer. As thicker the coating, as greater is the radius created along the cutting edge.

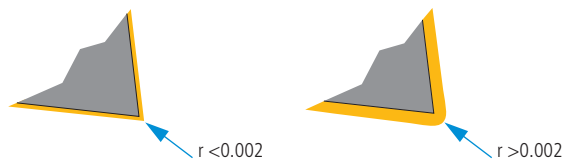

Comparison of default hardness values

Tensile strength (N/mm ²)	Vickers HV	Brinell HB	Rockwell HRC	Shore C
700	200	200	–	28
740	210	210	–	29
770	220	220	–	30
810	230	230	19.2	31
840	240	240	21.2	33
880	250	250	23	34
910	260	260	24.7	35
950	270	270	26.1	36
980	280	280	27.6	37
1020	290	290	29	39
1050	300	300	30.3	40
1090	310	310	31.5	41
1120	320	320	32.9	42
1150	330	330	33.8	43
1190	340	340	34.9	44
1230	350	350	36	45
1260	360	359	37	46
1300	370	368	38	47
1330	380	373	38.9	48
1370	390	385	39.8	49
1400	400	393	40.7	50
1440	410	400	41.5	51
1470	420	407	42.3	52
1510	430	416	43.2	53
1540	440	423	44	54
1580	450	429	44.8	55
1610	460	435	45.5	56
1650	470	441	46.3	57
1680	480	450	47	58
1720	490	457	47.7	59
1750	500	465	48.3	60
1790	510	474	49	61
1820	520	482	49.6	62
1860	530	489	50.3	63
1890	540	496	50.9	64
1930	550	503	51.5	65
1960	560	511	52.1	66
2000	570	520	52.7	67

Tensile strength (N/mm ²)	Vickers HV	Brinell HB	Rockwell HRC	Shore C
2030	580	527	53.3	68
2070	590	533	53.8	69
2100	600	533	54.4	70
2140	610	543	54.9	71
2170	620	549	55.4	72
2210	630	555	55.9	73
2240	640	561	56.4	74
2280	650	568	56.9	75
2310	660	574	57.4	75
2350	670	581	57.9	76
2380	680	588	58.7	77
2410	690	595	58.9	78
2450	700	602	59.3	79
2480	710	609	59.8	80
2520	720	616	60.2	81
2550	730	622	60.7	82
2590	740	627	61.1	83
2630	750	633	61.5	83
2660	760	639	61.9	84
2700	770	644	62.3	85
2730	780	650	62.7	86
2770	790	656	63.1	86
2800	800	661	63.5	87
2840	810	666	63.9	87
2870	820	670	64.3	88
2910	830	677	64.6	89
2940	840	682	65	89
2980	850	–	65.3	90
3010	860	–	65.7	90
3050	870	–	66	91
3080	880	–	66.3	91
3120	890	–	66.6	92
3150	900	–	66.9	92
3190	910	–	67.2	–
3220	920	–	67.5	–
3260	930	–	67.7	–
3290	940	–	68	–

A Flank wear

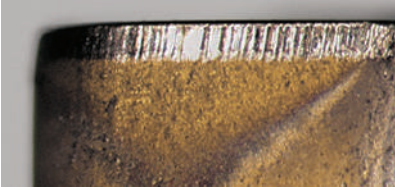

Reasons:

- Cutting speed too high
- Carbide grade with too little wear resistance
- Feed rate not adapted

Remedies:

- Reduce cutting speed
- Select better wear resistant carbide grade
- Adapt feed rate to cutting speed and cutting depth (increase feed rate)

Abrasion on flank, normal wear after a certain machining time.

B Edge chipping



Reasons:

- Grade with too high wear resistance
- Vibrations
- Feed rate too high or excessive cutting depth
- Interrupted cut
- Swarf damage

Remedies:

- Use tougher carbide grade
- Use negative cutting edge geometry with chip groove
- Increase stability (tool and work piece)

Through excessive mechanical stress at the cutting edge fracture and chipping can take place.

C Cratering



Reasons:

- Too high cutting speed and/or feed rate
- Rake angle too shallow
- Carbide grade with little wear resistance
- Insufficient coolant supply

Remedies:

- Reduce cutting speed and/or feed rate
- Increase coolant quantity and/or pressure, optimize coolant supply
- Use carbide grade which is more resistant to cratering

The hot chip which is being evacuated causes cratering at the rake face of the cutting edge.

D Plastic deformation



Reasons:

- Too high machining temperature, resulting in softening of substrate
- Damaged coatings

Remedies:

- Reduce cutting speed
- Choose carbide grade with higher wear resistance
- Provide cooling

High machining temperature and simultaneous mechanical stress can lead to plastic deformation.

E Built-up edges

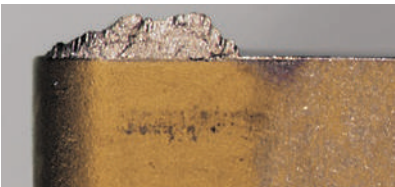

Reasons:

- Too low cutting speed
- Too small rake angle
- Wrong cutting material
- Lack of cooling/lubrication

Remedies:

- Increase cutting speed
- Enlarge rake angle
- Select more resistant coating
- Use emulsion with higher concentration

Built-up material/edges occur when the chip is not evacuated properly due to a too low cutting temperature.

F Insert breakage



Reasons:

- Excessive stress of cutting material
- Lack of stability
- Corner angle too small
- Excessive notching

Remedies:

- Use tougher carbide grade
- Use protective edge chamfer
- Increase honing of cutting edge
- Use more stable geometry

Excessive stress of the insert causes breakage.

Remedy / Measure	Cutting speed	Feed	Carbide toughness	Carbide hardness	Clearance angle	Rake angle	Stability	Rounded edge condition	Coolant	Face/radial runout
A* Excessive flank wear	↓	↑		↑						
B* Chipping of cutting edge	↑	↓	↑			🔍	↑	↑		
C* Excessive cratering	↓	↓		↑					↑	
D* Plastic deformation	↓	↓		↑		🔍			🔍	
E* Built up edge	↑	↑			🔍	↑		🔍	↑	
F* Insert breakage		↓	↑			🔍	↑			
Poor surface finish	↑	↓					↑	↓	🔍	↑
Chip forming, chip pile up					🔍	🔍			🔍	
Vibration	🔍	🔍			↓	↑	↑			↑
Hairline cracks	↓	↓	🔍		↓				↑	

* Further information 24...

↑ increase

↓ decrease

🔍 inspect, optimise

The cutting temperature particularly the wear depends significantly on the cutting conditions (v_c , f and a_p). Thermal causes of wear like oxidation and diffusion increase disproportionately.

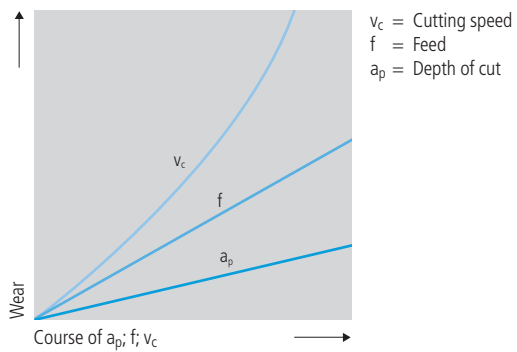

With the illustration below it is possible to achieve up different tooling situations. Choose yours and we will recommend you the suitable tooling solution.

Turning axial

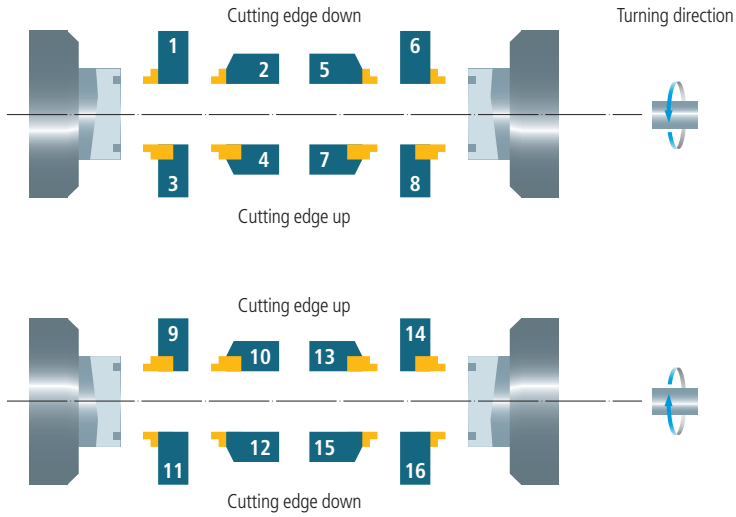

Situation	Execution	
	Holder	Insert
1	R	L
2	L	L
3	R	L
4	L	L
5	R	R
6	L	R
7	R	R
8	L	R
9	L	R
10	R	R
11	L	R
12	R	R
13	L	L
14	R	L
15	L	L
16	R	L

Turning axial (with holder 45°)

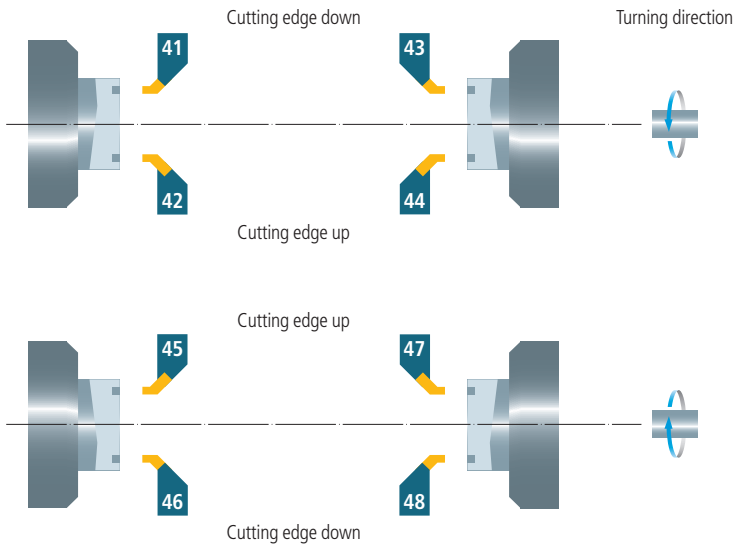

Situation	Execution	
	Holder	Insert
41	R	R
42	R	R
43	L	L
44	L	L
45	L	L
46	L	L
47	R	R
48	R	R

Turning radial outside

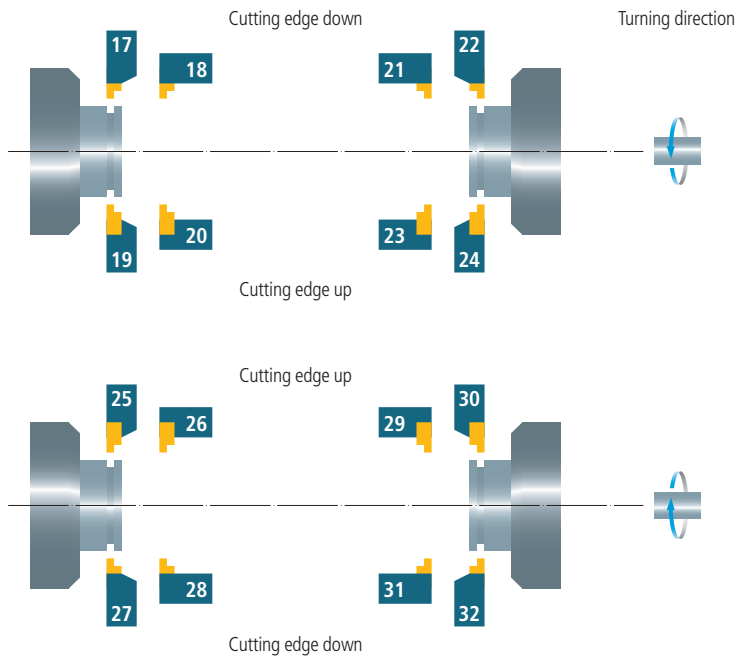

Situation	Execution	
	Holder	Insert
17	R	R
18	L	R
19	R	R
20	L	R
21	R	L
22	L	L
23	R	L
24	L	L
25	L	L
26	R	L
27	L	L
28	R	L
29	L	R
30	R	R
31	L	R
32	R	R

R = right L = left

Turning radial inside

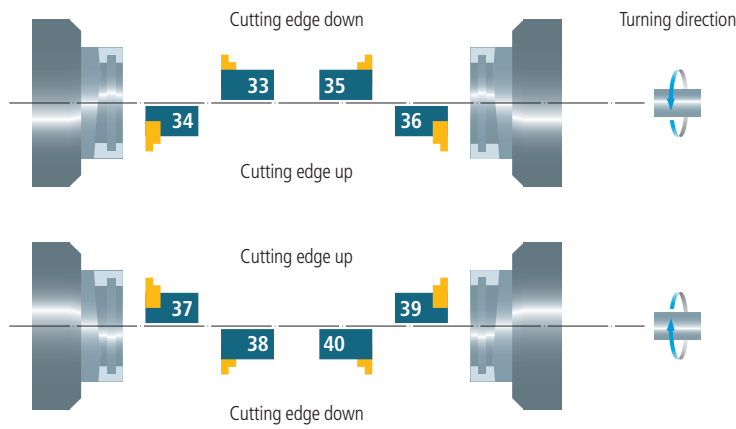

Situation	Execution	
	Holder	Insert
33	R	L
34	R	L
35	L	R
36	L	R
37	L	R
38	L	R
39	R	L
40	R	L

R = right L = left

Execution of holder/insert

The side on which the insert is located determines whether it is a "left-" or "right-hand" holder. For this purpose, the holder is viewed with the insert pointing towards the observer.



Left hand holder

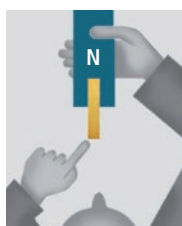

Neutral holder

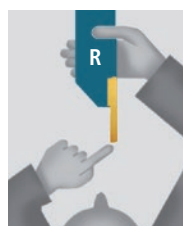

Right hand holder

Indexable inserts

Form of insert		
Index	α	
V	35°	
D	55°	
C	80°	

Clearance angle		
Index	α	
C	7°	
N	0°	
P	11°	

Tolerance			
Index	$s \pm$	$d \pm$	
E	0.025	0.025	
G	0.13	0.025	
M	0.13	0.05-0.15*	
X	0.1	0.04	

* Dependent on dimension of insert

Distinctive mark	
Index	
W	
T	
U	
X/Z	Special shape

DCGT 0702015 FN -A3 UHM 30 HX

Chip breaker	Carbide	Coating
178	20	23

Edge length			
Index	l	d	
06	6.4	6.35	
09	9.7	9.53	
12	12.9	12.7	
07	7.75	6.35	
11	11.6	9.53	
11	11.1	6.35	
16	16.6	9.53	
10	10	6.35	

Insert thickness		
Index	s	
02	2.38	
03	3.18	
T3	3.97	
04	4.76	

Corner radius	
Index	R
00/ZZ	0
003	0.03
006	0.06
008	0.08
01	0.1
015	0.15
02	0.2
035	0.35
04	0.4
075	0.75
08	0.8

Edge condition	
Index	
F	Sharp
E	Rounded

Cutting direction		
Index		
L	Left	
N	Neutral	
R	Right	

Holder OD turning

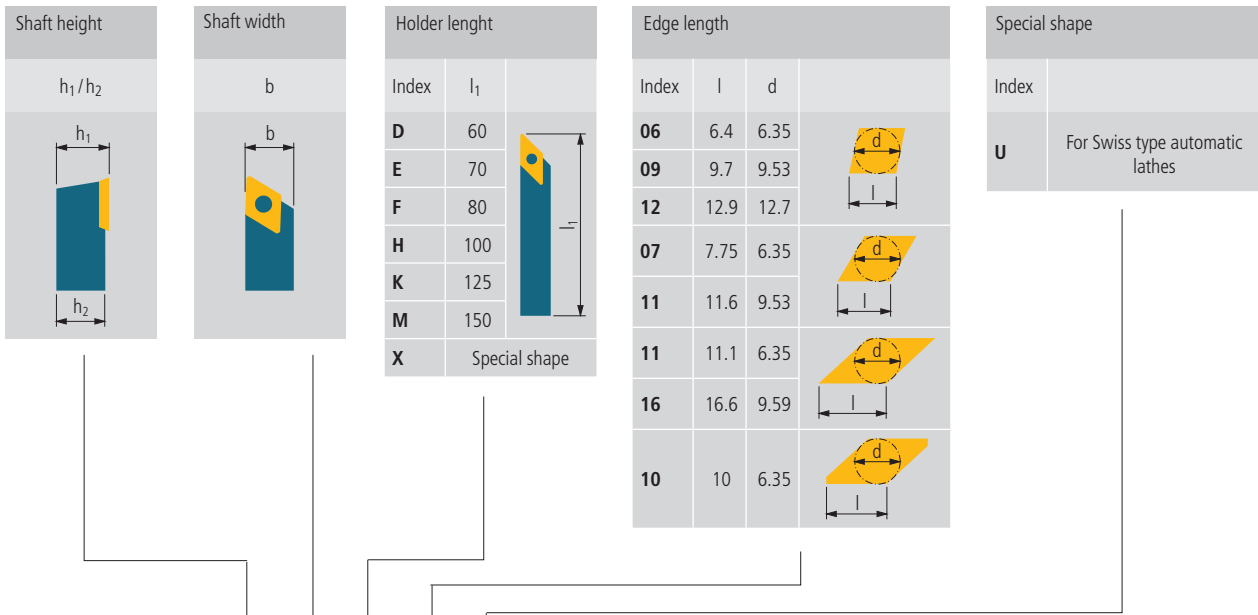

SDJCR 1212 H07 U

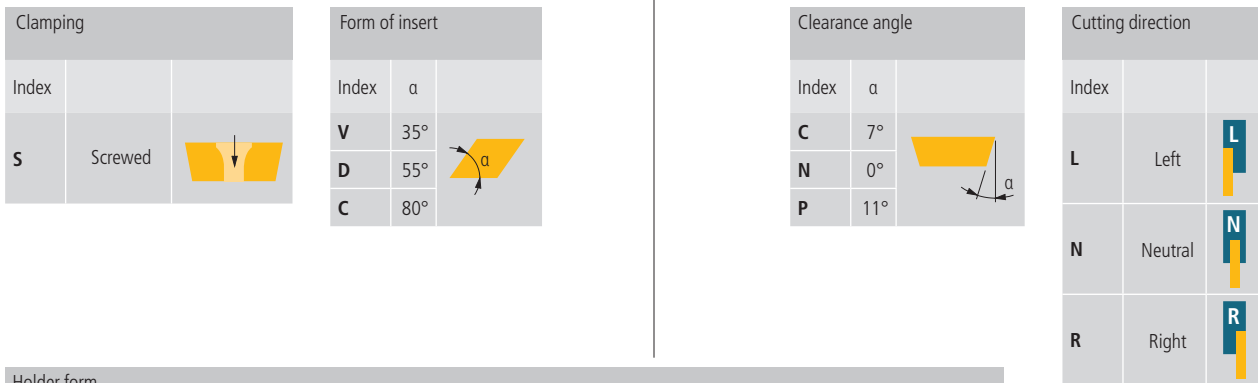

Holder form											
Index	α		Index	α		Index	α		Index	α	
A	90°		J	93°		P	117.5°		V	72.5°	
D	45°		L	95°		Q*	93°		X	Special shape	
H	107.5°		N	62.5°		U	93°				

* UTILIS standard

Holder ID turning

Shaft execution	
Index	
A	Steel shaft with internal cooling

Shaft diameter
d_1

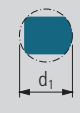



Holder length	
Index	l_1
F	80
H	100
K	125
M	150
Q	180
R	200
S	250
T	300
X...	Special







Edge length			
Index	l	d	
06	6.4	6.35	
09	9.7	9.53	
12	12.9	12.7	
07	7.75	6.35	
11	11.6	9.53	
11	11.1	6.35	
16	16.6	9.59	
10	10	6.35	







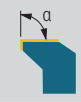

A12K SDUCR 07

Clamping		
Index		
S	Screwed	

Form of insert		
Index	α	
V	35°	
D	55°	
C	80°	

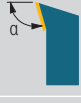
Clearance angle		
Index	α	
C	7°	
N	0°	
P	11°	

Cutting direction		
Index		
L	Left	
N	Neutral	
R	Right	

Holder form								
Index	α		Index	α		Index	α	
F	90°		L	95°		Q	107.5°	
D	45°		O	95°		U	93°	
J	93°		Q*	92°		X	Special shape	

* UTILIS standard

Formulas

Cutting speed (v_c)

$$v_c = \frac{d_1 \cdot \pi \cdot n}{1000} \text{ [m/min]}$$

Revolutions per minute (n)

$$n = \frac{v_c \cdot 1000}{d_1 \cdot \pi} \text{ [min}^{-1}\text{]}$$





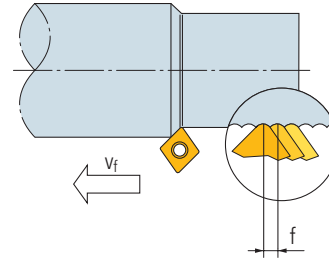
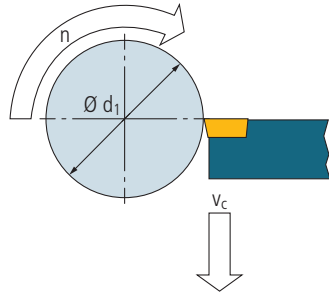



Feedrate (v_f)

$$v_f = f \cdot n \text{ [mm/min]}$$

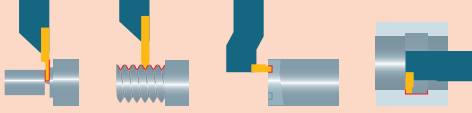
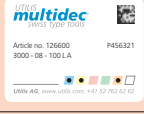











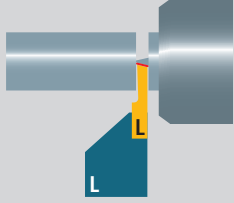

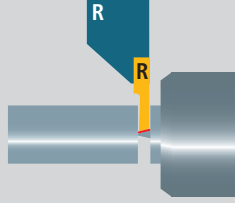

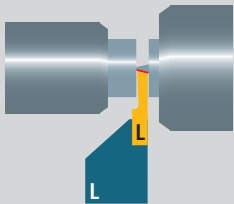

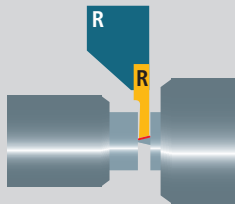

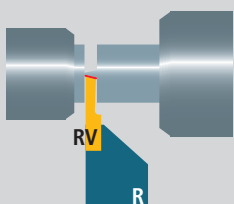

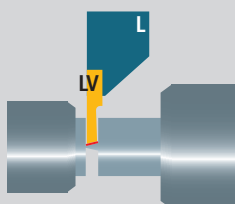

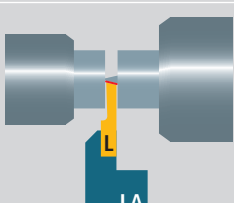

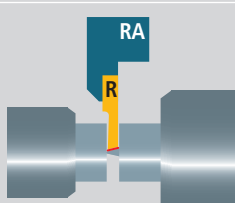

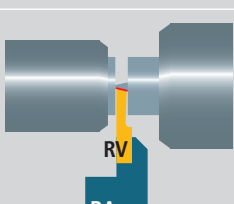

multidec®-CUT is most commonly used in OD-turning or alternatively in ID-turning. 5 systems are distinguished by the cutting depth or width and application field of machining process. All inserts are replaceable very easy and known for its great repeat accuracy. For cutting of all common materials we offer ideal adjusted micrograin carbides grades (K10–K40 PVD coated and uncoated).

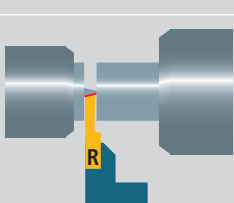

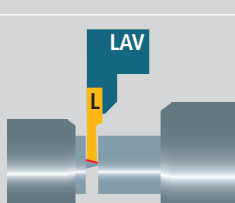

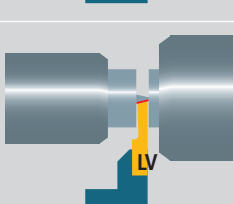





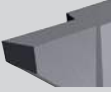





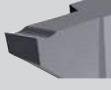

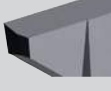



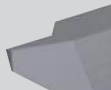

Application		Type	multidec®-CUT tool system (holder and insert)				
			500	1600	1700	3000	3600
	Maximum of bar diameter		16	10	10	32	20
	Blank	... 01	●	●	●	●	●
	CUT off	... 02		●		●	
	Front turning	... 03		●		●	
	Back turning	... 04		●		●	
	Copy turning	... 04 SP		●		●	
	Grooving and turning	... 05		●		●	●
	Threading	... 06		●	●	●	
	Radius-grooving	... 07		●		●	
	Grooving (radial)	... 10		●	●		
	Grooving (axial)	... 11		●	●		
	Chamfering	... 12		●		●	
Holder shank size			▨ 6–10	▨ 7–25 ▨ 3/8"–3/4" ⊗ 12–20	▨ 8–20 ▨ 3/8"–3/4" ⊗ 16	▨ 8–25 ▨ 3/8"–3/4"	▨ 10–25 ▨ 3/8"–3/4"

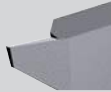

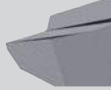

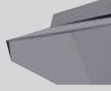

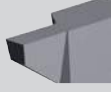

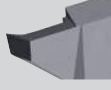
Technical information		11																																				
Machining methods		34																																				
Choice of insert		36																																				
Application 1600/1700/3000/3600		38																																				
Designation system		43																																				
Overview inserts and holders 500		45																																				
Overview inserts and holders 1600		49																																				
Overview inserts and holders 1700		97																																				
Overview inserts and holders 3000		111																																				
Overview inserts and holders 3600		161																																				
Cutting specification	<table border="1" data-bbox="831 1442 1150 1532"> <thead> <tr> <th></th> <th>1600-1700 Ausschneid- spannweite</th> <th>3000-3600 Ausschneid- spannweite</th> <th>3000-3600 Ausschneid- spannweite</th> <th>3000-3600 Ausschneid- spannweite</th> <th>3000-3600 Ausschneid- spannweite</th> </tr> </thead> <tbody> <tr> <td>Material</td> <td>1</td> <td>2</td> <td>3</td> <td>4</td> <td>5</td> </tr> <tr> <td>Geometrie</td> <td>1</td> <td>2</td> <td>3</td> <td>4</td> <td>5</td> </tr> <tr> <td>Bedingung</td> <td>▼</td> <td>▼</td> <td>▼</td> <td>▼</td> <td>▼</td> </tr> <tr> <td>Werkzeug</td> <td>▼</td> <td>▼</td> <td>▼</td> <td>▼</td> <td>▼</td> </tr> <tr> <td>Werkstoff</td> <td>▼</td> <td>▼</td> <td>▼</td> <td>▼</td> <td>▼</td> </tr> </tbody> </table>		1600-1700 Ausschneid- spannweite	3000-3600 Ausschneid- spannweite	3000-3600 Ausschneid- spannweite	3000-3600 Ausschneid- spannweite	3000-3600 Ausschneid- spannweite	Material	1	2	3	4	5	Geometrie	1	2	3	4	5	Bedingung	▼	▼	▼	▼	▼	Werkzeug	▼	▼	▼	▼	▼	Werkstoff	▼	▼	▼	▼	▼	168
	1600-1700 Ausschneid- spannweite	3000-3600 Ausschneid- spannweite	3000-3600 Ausschneid- spannweite	3000-3600 Ausschneid- spannweite	3000-3600 Ausschneid- spannweite																																	
Material	1	2	3	4	5																																	
Geometrie	1	2	3	4	5																																	
Bedingung	▼	▼	▼	▼	▼																																	
Werkzeug	▼	▼	▼	▼	▼																																	
Werkstoff	▼	▼	▼	▼	▼																																	
Recommendations for thread cutting		170																																				
Special tools – multidec4you®		600																																				
Accessories		603																																				

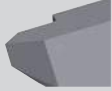
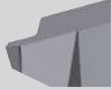
A different combination of holder and insert allows cutting even in difficult situations.

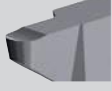
Main-spindle left	Possibilities of insert execution	Main-spindle left	Possibilities of insert execution	
				1
				2
				3
				4
				5
				6
				7
A		B		

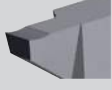
Main-spindle right	Possibilities of insert execution	Main-spindle right	Possibilities of insert execution	
				1
				2
				3
				4
				5
				6
				7
C		D		

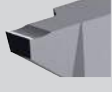
Application	Type and chip breaker		Machining Method			Characteristics
			▼	▼▼	▼▼▼	
		... 02	○	●	●	CUT off without chip breaker
			○	●	●	
			○	●	●	
			●	-	-	
		... 02 GS	○	●	●	CUT off with chip breaker
			●	○	-	
			○	○	-	
			-	○	●	
		... 02 SC	●	●	●	CUT off with chip breaker
			●	●	●	
			●	○	-	
			●	●	●	
		... 02 SPT	-	-	-	CUT off with chip breaker for tender material
			○	●	●	
			○	●	●	
			-	○	●	
		... 03	●	●	●	Front turning without chip breaker
			●	●	●	
			○	●	●	
			○	●	●	
		... 03 SP	○	●	●	Front turning with chip breaker
			○	●	●	
			○	●	●	
			-	○	●	
		... 03 CP TOP	○	●	●	Front turning with chip breaker and cutting edge "TOP"
			○	●	●	
			○	●	●	
			-	○	●	
		... 04	●	●	○	Back turning without chip breaker
			●	●	○	
			○	●	○	
			-	○	●	
		... 04 CP	○	●	●	Back turning with chip breaker
			○	●	●	
			○	●	●	
			-	○	●	
		... 04 SP	○	●	●	Copy turning with chip breaker
			○	●	●	
			○	●	●	
			-	○	●	
		... 04 TOP	○	●	●	Back turning with chip breaker and cutting edge "TOP"
			○	●	●	
			○	●	●	
			-	○	●	
		... 05	●	●	●	Grooving and turning without chip breaker
			○	●	○	
			○	○	-	
			○	●	●	
		... 05 CP	○	●	●	Grooving and turning with chip breaker
			○	●	●	
			○	●	●	
			-	-	●	

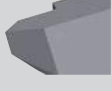
Application	Type and chip breaker		Machining Method			Characteristics
			▼	▼▼	▼▼▼	
		... 06	-	-	●	Threading partial profile
			-	-	●	
			-	-	●	
		... 06 VP	-	-	●	
			-	-	●	
			-	○	●	
		... 07	-	●	●	Radius-grooving
			-	●	●	
			-	●	●	
			-	○	●	
			-	●	●	
			-	●	●	
		... 10	-	●	●	Grooving radial
			-	●	●	
			-	●	●	
			-	○	●	
			-	●	●	
			-	●	●	
		... 11	-	●	●	Grooving axial
			-	●	●	
			-	●	●	
			-	○	●	
			-	●	●	
			-	●	●	
		... 12	-	●	●	Chamfering
			-	●	●	
			-	●	●	
			-	●	●	
			-	●	●	
			-	-	●	

CUT off

Inserts [1602...](#)

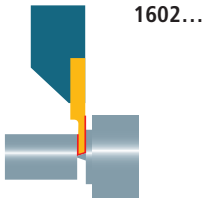

Front turning

Inserts [1603...](#)

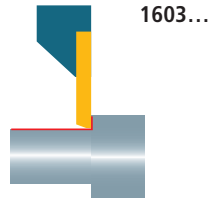

Copy turning (front)

Inserts [1604...](#)

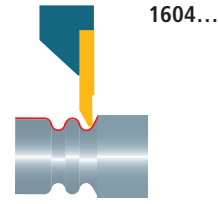

Copy turning (back)

Inserts [1604...](#)

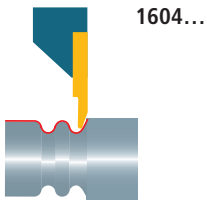

Back turning

Inserts [1604...](#)

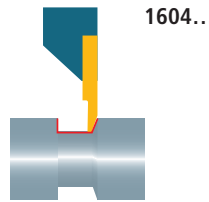

Grooving and Turning

Inserts [1605...](#)

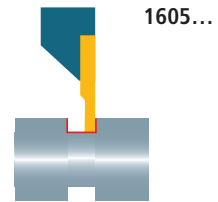

Threading

Inserts [1606...](#)

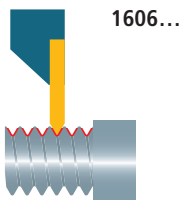

Radius-grooving

Inserts [1607...](#)

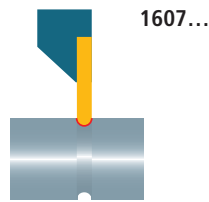

Grooving (radial)

Inserts [1610...](#)

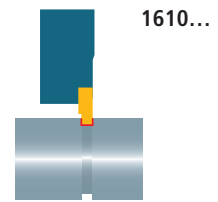

Grooving (axial)

Inserts [1611...](#)

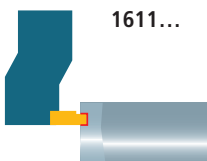

Chamfering

Inserts [1612...](#)

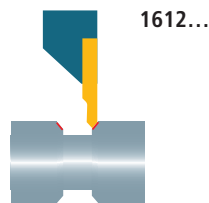

Front turning

Inserts [61...](#)

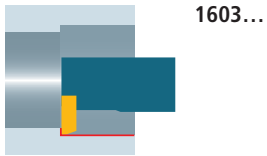

Copy turning (front)

Inserts [65...](#)

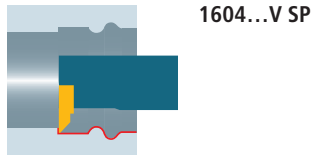

Copy turning (back)

Inserts [64...](#)

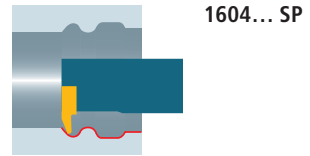

Back turning

Inserts [66...](#)

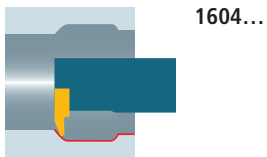

Grooving and Turning

Inserts [68...](#)

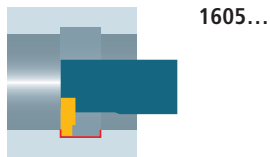

Threading

Inserts [73...](#)

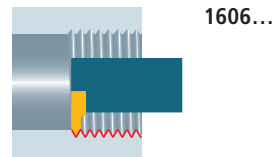

Radius-grooving

Inserts [75...](#)



Grooving

Inserts [76...](#)

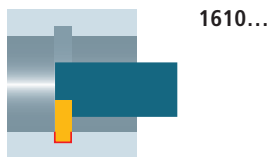

Chamfering

Inserts [79...](#)

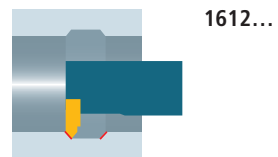

Holders [80...](#)

All illustrations show right hand design. Left hand design is also available.

Threading

Inserts [📄 99...](#)

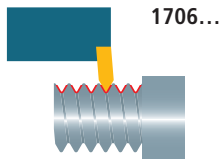

Grooving (radial)

Inserts [📄 100...](#)

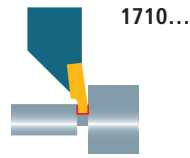

Grooving (axial)

Inserts [📄 101...](#)

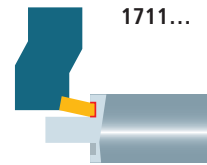

Application ID turning

Threading

Inserts [📄 99...](#)

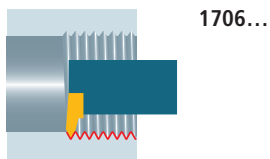

Grooving

Inserts [📄 100...](#)



Holders [📄 103...](#)

All illustrations show right hand design. Left hand design is also available.

CUT off

Inserts [114...](#)

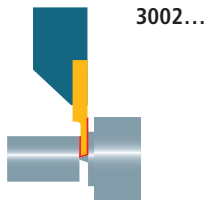

Front turning

Inserts [133...](#)

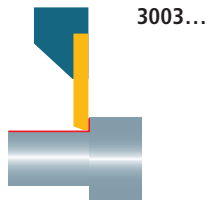

Copy turning (front)

Inserts [135...](#)

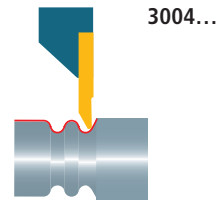

Copy turning (back)

Inserts [136...](#)

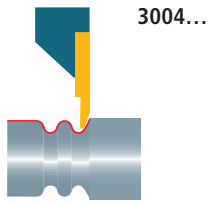

Back turning

Inserts [137...](#)

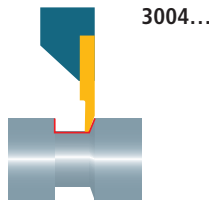

Grooving and Turning

Inserts [140...](#)

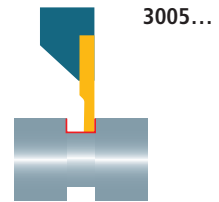

Threading

Inserts [142...](#)

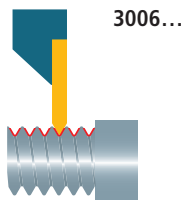

Radius-grooving

Inserts [147...](#)

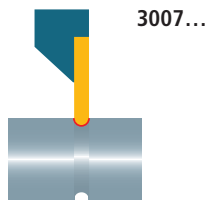

Chamfering

Inserts [148...](#)

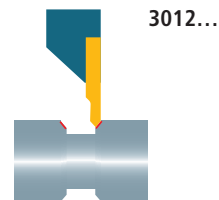

Holders [150...](#)

All illustrations show right hand design. Left hand design is also available.

Grooving and Turning

42

Inserts

163...

3605...



Holders

164...

All illustrations show right hand design. Left hand design is also available.

The designation of every insert and holder includes all important information according to the following system:

Inserts

3002 - 1.5 - 8L SC UHM20 HX

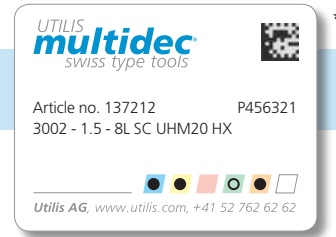
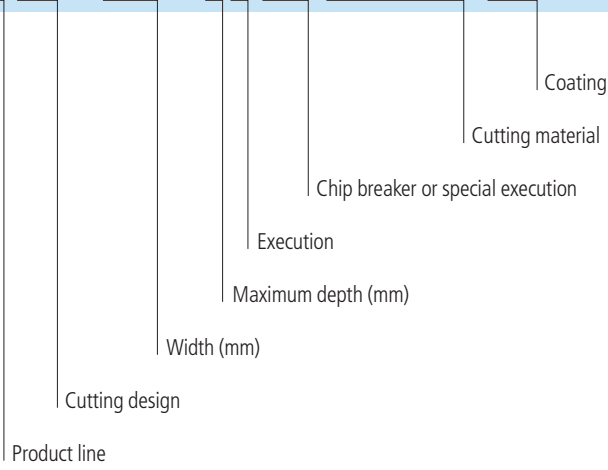

Holders

3000 - 08 - 100 LA

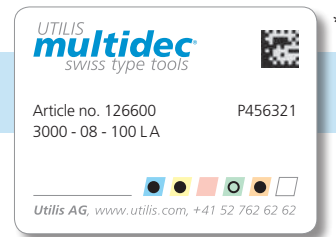
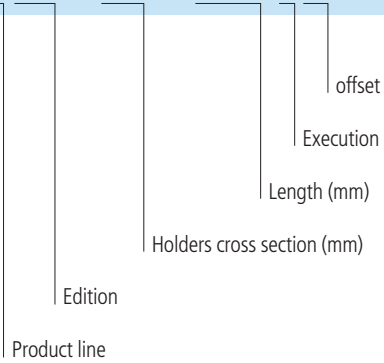

* Packaging Information 8

Legend 8...



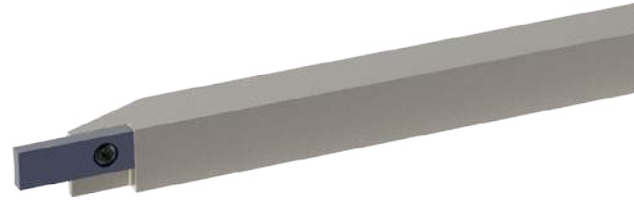

The turn and cut-off system 500 is suitable for Swiss type cam lathes up to bar diameter 15mm. The neutral cutting inserts, only available as blanks, consist of one cutting edge and will be mounted on tool holders with a repeatability of <math><0.01\text{ mm}</math>. Even for the ground, hardened and nickel plated holders a wide range of possibilities with shank sizes between 6 and 10 mm are available. For Swiss-type automatic lathes special holders have been designed and complete the wide range of choices.



Advantages:

- Replace brazed tools on cam machines
- Neutral inserts with mirror polished cutting face
- Coated and uncoated blanks available
- The machine operator can grind his own cutting geometries

Overview – multidec®-CUT 500

Technical information		11
Inserts		
501...		46
Holder		
500...		47
Replacement and spare parts		47

Blank

46

UTILIS
multidec[®]
swiss type tools

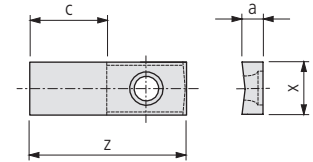

501...

Order designation	Carbide			Dimensions				Holder
	□ 20			a	c	x	z	□ 47...
<div style="display: flex; align-items: center;"> <div style="background-color: #0070c0; color: white; padding: 2px 5px; margin-right: 5px;">N</div> <div style="border-left: 2px solid #0070c0; border-right: 2px solid #0070c0; height: 15px; width: 10px; margin-right: 5px;"></div> </div>	-	-	●					
	-	○	●					
	○	○	●					
	-	-	●					
	UHM 10	UHM 10 HX	UHM 10 TX+					
PREMIUM-LINE								
501-2-6 NP ...*	■	■	■	2	8.5	6	17.8	500...
STANDARD-LINE								
501-2-6 N ...	■	■	■	2	8.5	6	17.8	500...

* Mirror polished

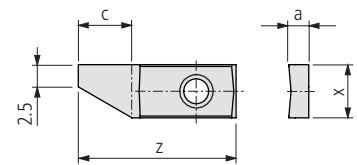

501...

Order designation	Carbide			Dimensions				Holder	
	□ 20			a	c	x	z	□ 47...	
<div style="display: flex; align-items: center;"> <div style="background-color: #0070c0; color: white; padding: 2px 5px; margin-right: 5px;">L</div> <div style="border-left: 2px solid #0070c0; border-right: 2px solid #0070c0; height: 15px; width: 10px; margin-right: 5px; margin-left: 20px;"></div> <div style="background-color: #0070c0; color: white; padding: 2px 5px; margin-left: 20px; margin-right: 5px;">R</div> <div style="border-left: 2px solid #0070c0; border-right: 2px solid #0070c0; height: 15px; width: 10px; margin-left: 5px;"></div> </div>	●	●	●						
	○	○	●						
	○	○	●						
	-	-	●						
	UHM 10	UHM 10 HX	UHM 10 TX+						
PREMIUM-LINE									
501-1.5-6 LP ...*	501-1.5-6 RP ...*	■	■	■	1.5	6	6	17.8	500...
501-2-6 LP ...*	501-2-6 RP ...*	■	■	■	2	8.5	6	17.8	500...

* Mirror polished

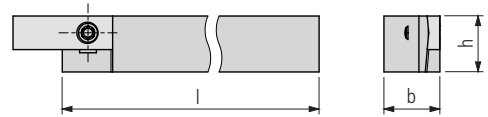
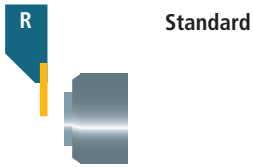

500...

Order designation		Dimensions							Inserts
L	R	h	b	l					□46...

STANDARD-LINE

500-06x130 N	■	500-06x130 N	■	6	6	130					501...
500-07x130 L	■	500-07x130 R	■	7	7	130					501...
500-08x130 L	■	500-08x130 R	■	8	8	130					501...
500-10x130 L	■	500-10x130 R	■	10	10	130					501...

500... INCH

Order designation		Dimensions							Inserts
L	R	b	h	l					□46...

STANDARD-LINE

500-3/8"x130 L	■	500-3/8"x130 R	■	9.525	9.525	130					501...
----------------	---	----------------	---	-------	-------	-----	--	--	--	--	--------

Replacement and spare parts

Illustration	Description	Dimensions	Order designation	Holder
	TORX screw	M2.5 x 6 T08	MSP 25060 T08	■ 500...

TORX screwdriver □651...

Legend □8...

The turn and cut-off system 1600 is suitable for Swiss type lathes up to bar diameter 10 mm. The cutting inserts consist of two cutting edges. Even for the holders a wide range of possibilities with shank sizes between 7 and 25 mm are available. For Swiss-type automatic lathes special holders have been designed and complete the wide range of choices.

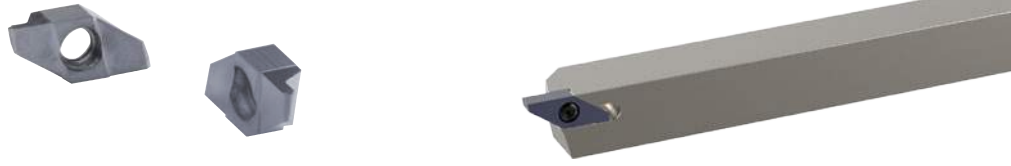

Advantages:

- Large selection of cutting geometries with different chip breakers especially made for smallest parts
- Full profile threading inserts starting from M 0.2 (0.06 mm pitch)
- Grooving inserts width starting from 0.05 mm



"IC" tool holder with integrated cooling

Cost-efficient processing of modern materials increasingly requires accurate control of the coolant at the cutting edge. Conveying the coolant as close as possible to the cutting edge is often a difficult task in the machine rooms of Swiss type turning lathes.

The multidec®-IC program offers a wide range of holders with integrated cooling. Because of the high precision and pressure, it is possible to discharge the chip quickly and safely from the cutting edge and the workpiece, which protects the cutting edge of the insert. This means significantly longer tool life as well as very reliable serial production.

Advantages:

- All holders feature five possible connectors for the coolant supply
- Fixed coolant exit allows for small set-up in front of the holder
- With or without high pressure, the coolant medium always hits the cutting edge precisely



"TWIN" holder with and without integrated coolant supply

The "TWIN" range allows you to work with two inserts on the same holder. Different combinations are possible, and provide the user with a high degree of flexibility. Holders are available with shank cross-sections of 8 to 20 mm, with and without internal cooling.

Advantages:

- Twice the number of tools on the machine
- Two different turning operations are possible with a single tool holder
- All holders with an integrated coolant supply have five connecting options



"Y-AXIS" holder with and without integrated coolant supply

Y-AXIS holders solve the chip control problems that can occur when cutting long-chip materials. With the Y-AXIS holder, the cutting edge is offset by 90° compared to the standard holder, whereby the chips fall in the bed of the machine. This prevents troublesome tumbling and flowing chips that can become caught on the cutting edge and damage it.

Benefits:

- Suitable for long chipping materials
- The problem of chip control is solved
- Holders with internal cooling
- All holders feature five possible connectors for the coolant supply

Technical information	11
-----------------------	----



Inserts	
1601...	51
1602..., 1602... V	52
1602... TOP, 1602... V TOP	54
1602... SC, 1602... V SC	55
1602... SC TOP, 1602... V SC TOP	56
1602... N SC	57
1602... SPT, 1602... V SPT	58
1602... N SPT	60
1603...	61
1603... SP	62
1603... CP TOP	63
1604... SP, 1604... V SP	64
1604... TOP	66
1604... SP TOP	67
1605...	68
1605... CP	69
1606... VP	70
1606... UN ... VP	71
1606-G ... VP	72
1606...	73
1606 HA... VP, 1606 HB... VP	74
1607...	75
1610...	76
1611...	77
1611-45...	78
1612...	79



Holders	
1600..., 1600... IC	80
1600...4, ...6, ...8	82
1600... A	84
1600... AV	85
1600/1600... TWIN, 1600/1600... IC TWIN	86
1600 YA... Y-AXIS	88
1600... 00 RD . IC	89
1600... 90 ST A	90
1600... 45 ST A	91
1600... 90 ST	92
1600... 90	93
1600... 90 RD . IC	94
1600... 6-8 90 RD . IC	95

Replacement and spare parts	95
-----------------------------	----



Coolant system and accessories	619
--------------------------------	-----



Blank

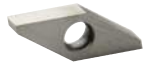

1601...

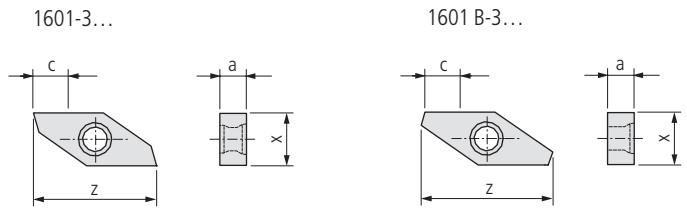

Order designation	Carbide						HSS		Dimensions				Holder
	UHM 10	UHM 10 HX	UHM 10 TX+	UHM 20	UHM 20 HPX	UHM 20 TX+	HSS	HSS HX	a	c	x	z	□ 80...
	-	-	●	○	●	●	●	●					
	○	●	●	○	●	●	○	○					
	●	○	-	●	○	-	-	○					
	-	-	●	-	○	○	-	-					

PREMIUM-LINE

1601-3-5 N P ...*				■	■	■			3	5	6	16	1600...
1601-4-5 N P ...*				■	■	■			4	5	6	16	1600...
1601-6-5 N P ...*				■	■	■			6	5	6	16	1600...
1601-8-5 N P ...*				■	■	■			8	5	6	16	1600...

STANDARD-LINE

1601-3-5 N ...				■	■	■	■	■	3	5	6	16	1600...
1601-4-5 N ...				■	■	■	■	■	4	5	6	16	1600...
1601-6-5 N ...				■	■	■	■	■	6	5	6	16	1600...
1601-8-5 N ...				■	■	■	■	■	8	5	6	16	1600...

VALUE-LINE

1601 B-3-5 N ...				■					3	5	6	16	1600...
------------------	--	--	--	---	--	--	--	--	---	---	---	----	---------

* Mirror polished

CUT off

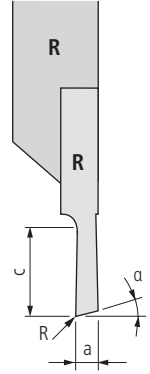
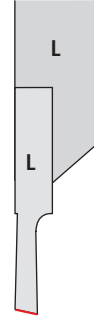
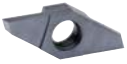

1602...

Order designation		Carbide						Dimensions				Holder	
		□ 20										□ 80...	
-	-	●	○	●	●		a	c	α	R			
○	●	●	○	○	○	○							
●	○	-	●	○	-	-							
-	-	●	-	○	○	○							
L	R	UHM 10	UHM 10 HX	UHM 10 TX+	UHM 20	UHM 20 HPX							
						UHM 20 TX+							

PREMIUM-LINE

1602-0.5-2.5 L G20 ...	1602-0.5-2.5 R G20 ...				■	■	■	0.5	2.5	20°	0			1600...
------------------------	------------------------	--	--	--	---	---	---	-----	-----	-----	---	--	--	---------

STANDARD-LINE

1602-0.8-5 L ...	1602-0.8-5 R ...				■	■	■	0.8	5	15°	0			1600...
1602-1.0-5 L ...	1602-1.0-5 R ...				■	■	■	1	5	15°	0			1600...
1602-1.2-5 L ...	1602-1.2-5 R ...				■	■	■	1.2	5	15°	0			1600...
1602-1.5-5 L ...	1602-1.5-5 R ...				■	■	■	1.5	5	15°	0			1600...

VALUE-LINE

1602 B-1.0-5 L ...	1602 B-1.0-5 R...				■	■		1	5	15°	0			1600...
1602 B-1.5-5 L ...	1602 B-1.5-5 R...				■	■		1.5	5	15°	0			1600...



CUT off



1602... V

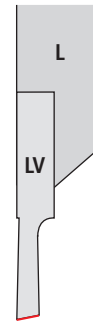

V: offset

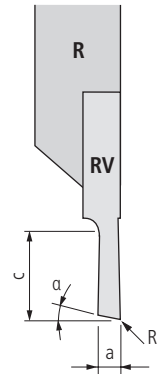

Order designation		Carbide						Dimensions				Holder	
		□ 20										□ 80...	
		-	-	●	○	●	●						
		-	●	●	○	●	●						
		○	●	●	○	○	●						
		●	○	-	●	○	-						
		-	-	●	-	○	○						
L	R	UHM 10	UHM 10 HX	UHM 10 TX+	UHM 20	UHM 20 HPX	UHM 20 TX+	a	c	α	R		
PREMIUM-LINE													
1602-0.5-2.5 LV G20 ...	1602-0.5-2.5 RV G20 ...			■	■	■		0.5	2.5	20°	-		1600...
STANDARD-LINE													
1602-0.8-5 LV ...	1602-0.8-5 RV ...			■	■	■		0.8	5	15°	-		1600...
1602-1.0-5 LV ...	1602-1.0-5 RV ...			■	■	■		1	5	15°	-		1600...
1602-1.2-5 LV ...	1602-1.2-5 RV ...			■	■	■		1.2	5	15°	-		1600...
1602-1.5-5 LV ...	1602-1.5-5 RV ...			■	■	■		1.5	5	15°	-		1600...
VALUE-LINE													
1602 B-1.0-5 LV ...	1602 B-1.0-5 RV ...			■	■			1	5	15°	-		1600...
1602 B-1.5-5 LV ...	1602 B-1.5-5 RV ...			■	■			1.5	5	15°	-		1600...

Turning and cut off

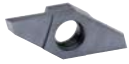

1602... TOP*

Detail TOP*

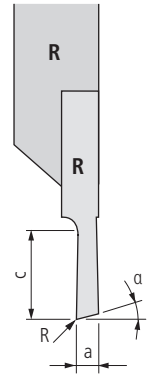
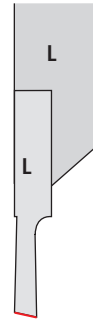
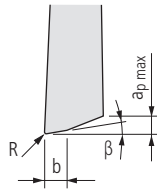

Order designation	Carbide						Dimensions							Holder
	-	-	●	○	●	●	a	c	α	R	β	b	ap max	□ 80...
L	UHM 10	UHM 10 HX	UHM 10 TX+	UHM 20	UHM 20 HPX	UHM 20 TX+								

STANDARD-LINE

1602-1.5-5 L TOP 008 ...	1602-1.5-5 R TOP 008 ...				■	■	■	1.5	5	15°	0.08	1.5°	0.3	0.3	1600...
--------------------------	--------------------------	--	--	--	---	---	---	-----	---	-----	------	------	-----	-----	---------

* Description TOP □ 13



1602... V TOP*

Detail TOP*

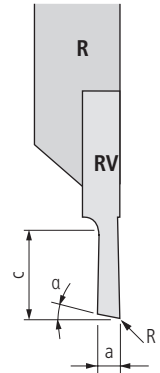
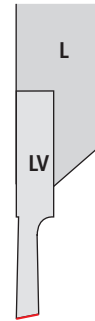
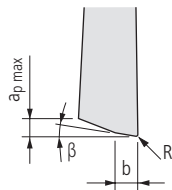

Order designation	Carbide						Dimensions							Holder
	-	-	●	○	●	●	a	c	α	R	β	b	ap max	□ 80...
L	UHM 10	UHM 10 HX	UHM 10 TX+	UHM 20	UHM 20 HPX	UHM 20 TX+								

STANDARD-LINE

1602-1.5-5 LV TOP 008 ...	1602-1.5-5 RV TOP 008 ...				■	■	■	1.5	5	15°	0.08	1.5°	0.3	0.3	1600...
---------------------------	---------------------------	--	--	--	---	---	---	-----	---	-----	------	------	-----	-----	---------

* Description TOP □ 13

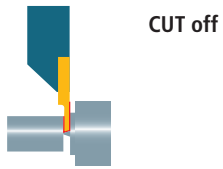

1602... SC

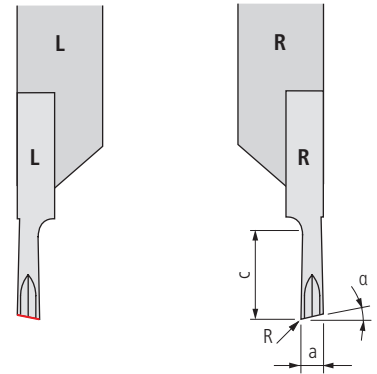

Order designation		Carbide						Dimensions				Holder	
		□ 20										□ 80...	
L	R	-	-	●	○	●	●	a	c	α	R		
		-	●	●	○	○	●						
		○	●	●	○	○	●						
		●	○	-	●	○	-						
		-	-	●	-	○	-						
		UHM 10	UHM 10 HX	UHM 10 TX+	UHM 20	UHM 20 HPX	UHM 20 TX+						
STANDARD-LINE													
1602-1.5-5 L SC ...	1602-1.5-5 R SC ...				■	■	■	1.5	5	15°	-		1600...



1602... V SC

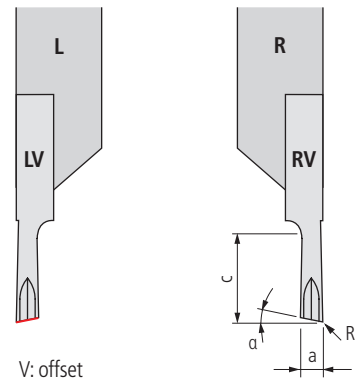

Order designation		Carbide						Dimensions				Holder	
		□ 20										□ 80...	
L	R	-	-	●	○	●	●	a	c	α	R		
		-	●	●	○	○	●						
		○	●	●	○	○	●						
		●	○	-	●	○	-						
		-	-	●	-	○	-						
		UHM 10	UHM 10 HX	UHM 10 TX+	UHM 20	UHM 20 HPX	UHM 20 TX+						
STANDARD-LINE													
1602-1.5-5 LV SC ...	1602-1.5-5 RV SC ...				■	■	■	1.5	5	15°	-		1600...

Turning and cut off



1602... SCTOP*

Detail TOP*

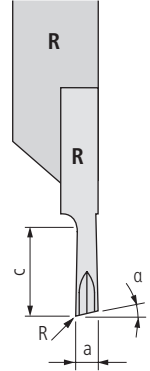
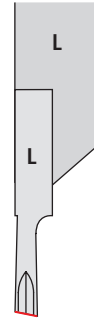
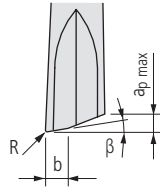

Order designation	Carbide						Dimensions							Holder
	-	-	●	○	●	●	a	c	α	R	β	b	ap max	□ 80...
L	-	-	●	○	●	●	1.5	5	15°	0.08	1.5°	0.3	0.3	1600...
R	-	-	●	○	●	●	1.5	5	15°	0.08	1.5°	0.3	0.3	1600...
	UHM 10	UHM 10 HX	UHM 10 TX+	UHM 20	UHM 20 HPX	UHM 20 TX+								

STANDARD-LINE

1602-1.5-5 L SC TOP 008 ...	1602-1.5-5 R SC TOP 008 ...													
-----------------------------	-----------------------------	--	--	--	--	--	--	--	--	--	--	--	--	--

* Description TOP □ 13



1602... V SC TOP*

Detail TOP*

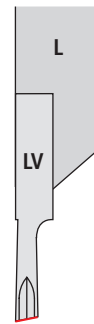
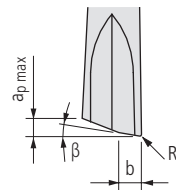

V: offset

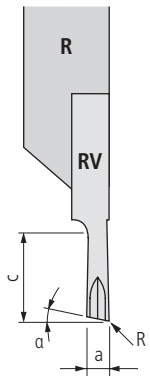

Order designation	Carbide						Dimensions							Holder
	-	-	●	○	●	●	a	c	α	R	β	b	ap max	□ 80...
L	-	-	●	○	●	●	1.5	5	15°	0.08	1.5°	0.3	0.3	1600...
R	-	-	●	○	●	●	1.5	5	15°	0.08	1.5°	0.3	0.3	1600...
	UHM 10	UHM 10 HX	UHM 10 TX+	UHM 20	UHM 20 HPX	UHM 20 TX+								

STANDARD-LINE

1602-1.5-5 LV SC TOP 008 ...	1602-1.5-5 RV SC TOP 008 ...													
------------------------------	------------------------------	--	--	--	--	--	--	--	--	--	--	--	--	--

* Description TOP □ 13



CUT off



1602... N SC

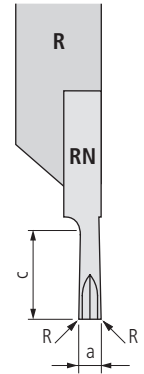
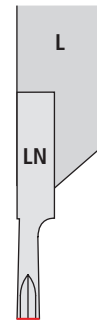

N: neutral

Order designation		Carbide						Dimensions						Holder
		□ 20												□ 80...
		-	-	●	○	●	●							
		-	●	●	○	●	●							
		○	●	●	○	○	●							
		●	○	-	●	○	-							
		-	-	●	-	○	-							
L	R	UHM 10	UHM 10 HX	UHM 10 TX+	UHM 20	UHM 20 HPX	UHM 20 TX+	a	c	R				
STANDARD-LINE		1602-1.5-5 LN SC ...	1602-1.5-5 RN SC ...			■	■	1.5	5	0.05				1600...

CUT off

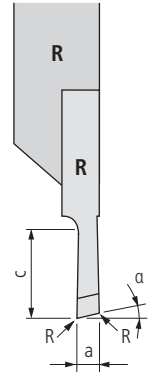
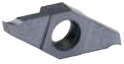

1602... SPT

Order designation	Carbide						Dimensions						Holder □80...
	-	-	●	○	●	●	a	c	α	β	R	s	
L	UHM 10	UHM 10 HX	UHM 10 TX+	UHM 20	UHM 20 HPX	UHM 20 TX+							
R													

PREMIUM-LINE

1602-0.5-2.5 L SPT G20 ...	1602-0.5-2.5 R SPT G20 ...				■	■	■	0.5	2.5	20°	20°	-	2	1600...
----------------------------	----------------------------	--	--	--	---	---	---	-----	-----	-----	-----	---	---	---------

STANDARD-LINE

1602-0.8-5 L SPT ...	1602-0.8-5 R SPT ...				■	■	■	0.8	5	15°	20°	-	2	1600...
1602-1.0-5 L SPT ...	1602-1.0-5 R SPT ...				■	■	■	1	5	15°	20°	-	2	1600...
1602-1.0-5 L SPT06 ...	1602-1.0-5 R SPT06 ...				■	■	■	1	5	15°	6°	0.05	2	1600...
1602-1.0-5 L SPT12 ...	1602-1.0-5 R SPT12 ...				■	■	■	1	5	15°	12°	0.05	2	1600...
1602-1.2-5 L SPT ...	1602-1.2-5 R SPT ...				■	■	■	1.2	5	15°	20°	-	2	1600...
1602-1.5-5 L SPT ...	1602-1.5-5 R SPT ...				■	■	■	1.5	5	15°	20°	-	2	1600...
1602-1.5-5 L SPT06 ...	1602-1.5-5 R SPT06 ...				■	■	■	1.5	5	15°	6°	0.05	2	1600...
1602-1.5-5 L SPT12 ...	1602-1.5-5 R SPT12 ...				■	■	■	1.5	5	15°	12°	0.05	2	1600...

VALUE-LINE

1602 B-1.0-5 L SPT06 ...	1602 B-1.0-5 R SPT06 ...				■	■		1	5	15°	6°	0.05	2	1600...
1602 B-1.5-5 L SPT06 ...	1602 B-1.5-5 R SPT06 ...				■	■		1.5	5	15°	6°	0.05	2	1600...



CUT off

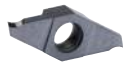

1602... V SPT

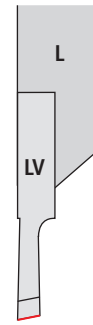

V: offset

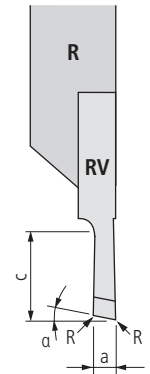

Order designation	Carbide						Dimensions						Holder
	UHM 10	UHM 10 HX	UHM 10 TX+	UHM 20	UHM 20 HPX	UHM 20 TX+	a	c	α	β	R	s	$\square 80...$
L	-	-	●	○	●	●							
	-	●	●	●	●	●							
	○	○	○	○	○	○							
	●	○	-	●	○	-							
	-	-	●	-	○	-							

PREMIUM-LINE

1602-0.5-2.5 LV SPT G20 ...	1602-0.5-2.5 RV SPT G20 ...				■	■	■	0.5	2.5	20°	20°	-	2	1600...
-----------------------------	-----------------------------	--	--	--	---	---	---	-----	-----	-----	-----	---	---	---------

STANDARD-LINE

1602-0.8-5 LV SPT ...	1602-0.8-5 RV SPT ...				■	■	■	0.8	5	15°	20°	-	2	1600...
1602-1.0-5 LV SPT ...	1602-1.0-5 RV SPT ...				■	■	■	1	5	15°	20°	-	2	1600...
1602-1.0-5 LV SPT06 ...	1602-1.0-5 RV SPT06 ...				■	■	■	1	5	15°	6°	0.05	2	1600...
1602-1.0-5 LV SPT12 ...	1602-1.0-5 RV SPT12 ...				■	■	■	1	5	15°	12°	0.05	2	1600...
1602-1.2-5 LV SPT ...	1602-1.2-5 RV SPT ...				■	■	■	1.2	5	15°	20°	-	2	1600...
1602-1.5-5 LV SPT ...	1602-1.5-5 RV SPT ...				■	■	■	1.5	5	15°	20°	-	2	1600...
1602-1.5-5 LV SPT06 ...	1602-1.5-5 RV SPT06 ...				■	■	■	1.5	5	15°	6°	0.05	2	1600...
1602-1.5-5 LV SPT12 ...	1602-1.5-5 RV SPT12 ...				■	■	■	1.5	5	15°	12°	0.05	2	1600...

VALUE-LINE

1602 B-1.0-5 LV SPT06 ...	1602 B-1.0-5 RV SPT06 ...				■	■		1	5	15°	6°	0.05	2	1600...
1602 B-1.5-5 LV SPT06 ...	1602 B-1.5-5 RV SPT06 ...				■	■		1.5	5	15°	6°	0.05	2	1600...

60

UTILIS
multidec[®]
swiss type tools

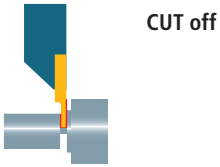

1602... N SPT

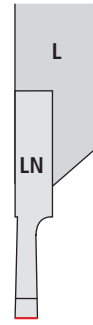
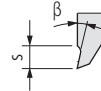

N: neutral

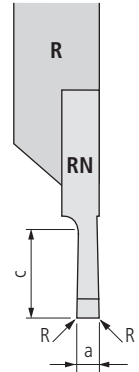

Order designation	Carbide						Dimensions					Holder □80...
	-	-	●	○	●	●	a	c	R	s	β	
L	UHM 10	UHM 10 HX	UHM 10 TX+	UHM 20	UHM 20 HPX	UHM 20 TX+						
R												

PREMIUM-LINE

1602-0.5-2.5-LN SPT ...	1602-0.5-2.5-RN SPT ...				■	■	■	0.5	2.5	0.05	2	20°		1600...
-------------------------	-------------------------	--	--	--	---	---	---	-----	-----	------	---	-----	--	---------

STANDARD-LINE

1602-0.8-5 LN SPT ...	1602-0.8-5 RN SPT ...				■	■	■	0.8	5	0.05	2	20°		1600...
1602-1.0-5 LN SPT ...	1602-1.0-5 RN SPT ...				■	■	■	1	5	0.05	2	20°		1600...
1602-1.0-5 LN SPT06 ...	1602-1.0-5 RN SPT06 ...				■	■	■	1	5	0.05	2	6°		1600...
1602-1.0-5 LN SPT12 ...	1602-1.0-5 RN SPT12 ...				■	■	■	1	5	0.05	2	12°		1600...
1602-1.2-5 LN SPT ...	1602-1.2-5 RN SPT ...				■	■	■	1.2	5	0.05	2	20°		1600...
1602-1.5-5 LN SPT ...	1602-1.5-5 RN SPT ...				■	■	■	1.5	5	0.05	2	20°		1600...
1602-1.5-5 LN SPT06 ...	1602-1.5-5 RN SPT06 ...				■	■	■	1.5	5	0.05	2	6°		1600...
1602-1.5-5 LN SPT12 ...	1602-1.5-5 RN SPT12 ...				■	■	■	1.5	5	0.05	2	12°		1600...

VALUE-LINE

1602 B-1.0-5 LN SPT06 ...	1602 B-1.0-5 RN SPT06 ...				■	■		1	5	0.05	2	6°		1600...
1602 B-1.5-5 LN SPT06 ...	1602 B-1.5-5 RN SPT06 ...				■	■		1.5	5	0.05	2	6°		1600...

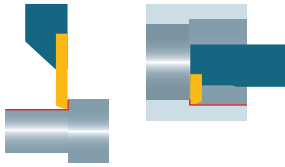

Front turning



1603...

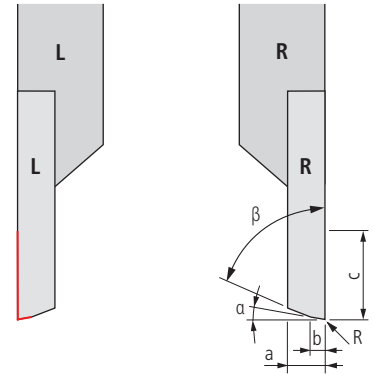

Order designation	Carbide						Dimensions						Holder
	-	-	●	○	●	●	a	b	c	α	β	R	□ 80...
L	○	●	●	○	●	●							
R	-	○	-	-	○	-							
	UHM 10	UHM 10 HX	UHM 10 TX+	UHM 20	UHM 20 HPX	UHM 20 TX+							

STANDARD-LINE

1603-3.0-4 L ...	1603-3.0-4 R ...			■	■	■	3	1	4	3°	70°	-	1600...
1603-3.0-5 L 55008 ...	1603-3.0-5 R 55008 ...			■	■	■	3	-	4	-	55°	0.08	1600...
1603-3.0-5 L 55015 ...	1603-3.0-5 R 55015 ...			■	■	■	3	-	4	-	55°	0.15	1600...
1603-3.0-5 L 35008 ...	1603-3.0-5 R 35008 ...			■	■	■	3	-	4	-	35°	0.08	1600...
1603-3.0-5 L 35015 ...	1603-3.0-5 R 35015 ...			■	■	■	3	-	4	-	35°	0.15	1600...

VALUE-LINE

1603 B-3.0-4 L ...	1603 B-3.0-4 R ...			■	■		3	1	4	3°	70°	-	1600...
--------------------	--------------------	--	--	---	---	--	---	---	---	----	-----	---	---------

Front turning

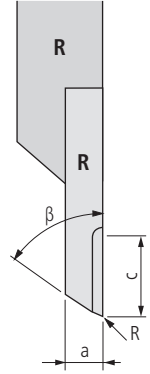
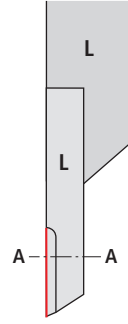
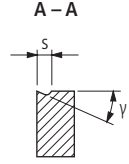
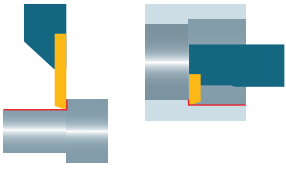

1603... SP U...

Order designation	Carbide						Dimensions						Holder
	-	-	●	○	●	●	a	c	β	R	s	γ	□80...
L	-	-	●	○	●	●							
R	-	○	-	-	○	-							
	UHM 10	UHM 10 HX	UHM 10 TX+	UHM 20	UHM 20 HPX	UHM 20 TX+							

STANDARD-LINE

1603-3.0-4 L SP U55003 ...	1603-3.0-4 R SP U55003 ...			■	■	■	3	4	55°	0.03	1	12°	1600...
1603-3.0-4 L SP U55008 ...	1603-3.0-4 R SP U55008 ...			■	■	■	3	4	55°	0.08	1	12°	1600...
1603-3.0-4 L SP U55015 ...	1603-3.0-4 R SP U55015 ...			■	■	■	3	4	55°	0.15	1	12°	1600...
1603-3.0-4 L SP U35003 ...	1603-3.0-4 R SP U35003 ...			■	■	■	3	4	35°	0.03	1	12°	1600...
1603-3.0-4 L SP U35008 ...	1603-3.0-4 R SP U35008 ...			■	■	■	3	4	35°	0.08	1	12°	1600...
1603-3.0-4 L SP U35015 ...	1603-3.0-4 R SP U35015 ...			■	■	■	3	4	35°	0.15	1	12°	1600...



Front turning



1603... CP TOP*

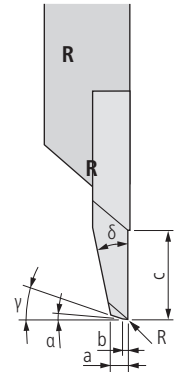
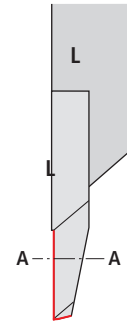
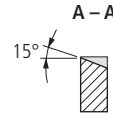

Order designation	Carbide						Dimensions							Holder	
	□ 20						a	b	c	α	γ	R	δ	□ 80...	
<div style="display: flex; justify-content: space-around;"> <div style="text-align: center;"> L </div> <div style="text-align: center;"> R </div> </div>	-	-	●	○	●	●									
	-	●	●	○	●	●									
	○	●	●	○	○	●	●								
	●	○	-	●	○	-									
	-	-	●	-	-	○									

STANDARD-LINE

1603-3.0-3.5 L CP TOP ZZ ...	1603-3.0-3.5 R CP TOP ZZ ...				■	■	■	0.8	0.2	4	1°	2°	-	25°	1600...
1603-3.0-3.5 L CP TOP 003 ...	1603-3.0-3.5 R CP TOP 003 ...				■	■	■	0.8	0.2	4	1°	2°	0.03	25°	1600...

* Description TOP □ 13

Copy turning (back)

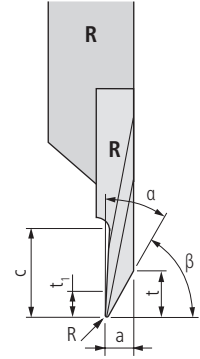
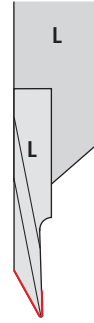
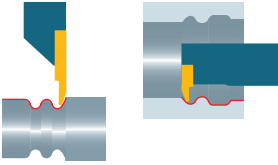

1604... SP

Order designation	Carbide						Holder
	□ 20						
	-	-	●	○	●	●	□ 80...
	-	●	●	○	●	●	
	○	●	●	○	●	●	
	●	○	-	●	○	-	
	-	-	●	-	-	○	
	-	-	●	-	-	○	
L	UHM 10	UHM 10 HX	UHM 10 TX+	UHM 20	UHM 20 HPX	UHM 20 TX+	
R							
	a	c	α	β	R	t	t ₁

STANDARD-LINE

1604-1.25-2-3 L SP29005 ...	1604-1.25-2-3 R SP29005 ...			■	■	■	1.25	2.5	29°	61°	0.05	2	1	1600...
1604-2.5-4-5 L SP29005 ...	1604-2.5-4-5 R SP29005 ...			■	■	■	2.5	5	29°	61°	0.05	4	2	1600...
1604-2.5-4-5 L SP29015 ...	1604-2.5-4-5 R SP29015 ...			■	■	■	2.5	5	29°	61°	0.15	4	2	1600...

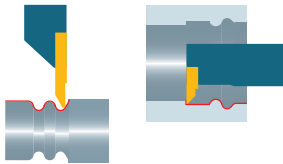

Copy turning (front)



1604... V SP

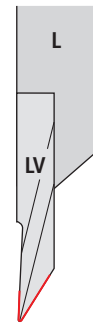

V: offset

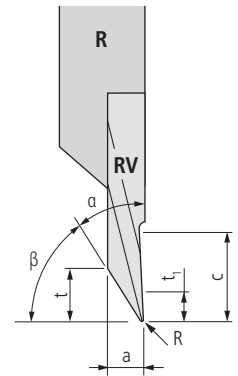

Order designation	Carbide						Holder
	UHM 10	UHM 10 HX	UHM 10 TX+	UHM 20	UHM 20 HPX	UHM 20 TX+	
	-	-	●	○	●	●	□ 80...
	-	●	●	○	●	●	
	○	●	●	○	●	●	
	●	○	-	●	○	-	
	-	-	●	-	-	○	
	-	-	●	-	-	○	

STANDARD-LINE

Order designation		Carbide	Holder	a	c	α	β	R	t	t ₁	1600...
1604-2.5-4-5 LV SP29005 ...	1604-2.5-4-5 RV SP29005 ...	■ ■ ■	□ 80...	2.5	5	29°	61°	0.05	4	2	1600...
1604-2.5-4-5 LV SP29015 ...	1604-2.5-4-5 RV SP29015 ...	■ ■ ■	□ 80...	2.5	5	29°	61°	0.15	4	2	1600...

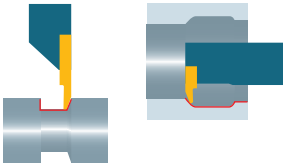

Back turning



1604... TOP*

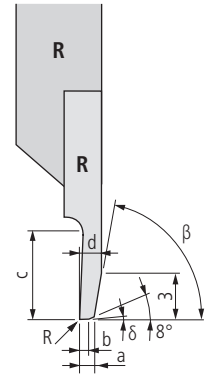
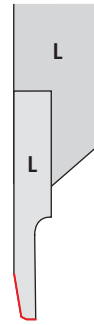

Order designation	Carbide						Dimensions								Holder
	-	-	●	○	●	●	a	b	c	d	β	R	δ	□80...	
L	UHM 10	UHM 10 HX	UHM 10 TX+	UHM 20	UHM 20 HPX	UHM 20 TX+									

STANDARD-LINE

1604-0.15-2 L TOP ZZ ...	1604-0.15-2 R TOP ZZ ...				■	■	■	0.15	0.05	2	1	70°	-	-	1600...
1604-0.2-2 L TOP 008 ...	1604-0.2-2 R TOP 008 ...				■	■	■	0.25	0.15	2	1	70°	0.08	-	1600...
1604-0.4-4 L TOP 008 ...	1604-0.4-4 R TOP 008 ...				■	■	■	0.4	0.15	4	1.6	70°	0.08	-	1600...
1604-0.8-4 L TOP 008 ...	1604-0.8-4 R TOP 008 ...				■	■	■	0.8	0.15	4	2	70°	0.08	-	1600...
1604-1.2-4 L TOP ZZ ...	1604-1.2-4 R TOP ZZ ...				■	■	■	1.2	0.5	4	2.4	70°	-	1°	1600...

VALUE-LINE

1604 B-0.8-4 L TOP 008 ...	1604 B-0.8-4 R TOP 008 ...				■	■		0.8	0.15	4	2	70°	0.08	-	1600...
1604 B-1.2-4 L TOP ZZ ...	1604 B-1.2-4 R TOP ZZ ...				■	■		1.2	0.5	4	2.4	70°	-	1°	1600...

* Description TOP □13

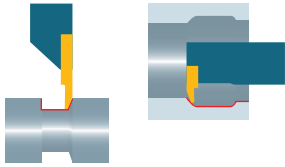

Back turning

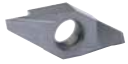

1604... SP TOP*

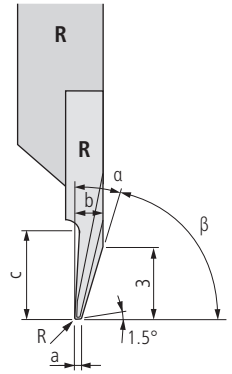
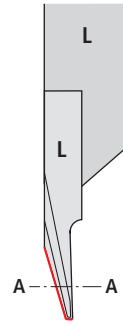
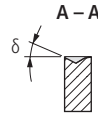

Order designation	Carbide						Dimensions							Holder
	UHM 10	UHM 10 HX	UHM 10 TX+	UHM 20	UHM 20 HPX	UHM 20 TX+	a	c	b	α	β	δ	R	□ 80...
L	-	-	●	○	●	●								
	-	●	●	○	●	●								
	○	●	●	○	●	●								
	●	○	-	●	○	-								
	-	-	●	-	○	-								
							a	c	b	α	β	δ	R	

STANDARD-LINE

1604-1.5-3 L SP TOP 20ZZ ...	1604-1.5-3 R SP TOP 20ZZ ...			■	■	■	0.3	3	1.5	20°	70°	15°	-	1600...
1604-1.5-3 L SP TOP 20005 ...	1604-1.5-3 R SP TOP 20005 ...			■	■	■	0.3	3	1.5	20°	70°	15°	0.05	1600...

* Description TOP □ 13

Grooving and turning

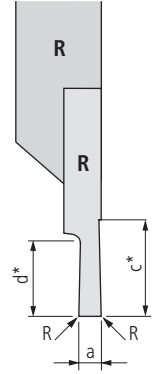
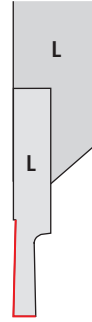
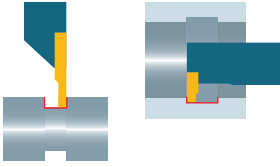

1605...

Order designation		Carbide						Dimensions				Holder	
		-	-	●	○	●	●	a	c*	d*	R		□ 80...
L		-	-	●	○	●	●						
		○	●	●	○	○	○						
		●	○	-	●	○	-						
		-	-	●	-	-	○						
R		UHM 10	UHM 10 HX	UHM 10 TX+	UHM 20	UHM 20 HPX	UHM 20 TX+						

STANDARD-LINE

1605-0.5-1.5 L ...	1605-0.5-1.5 R ...				■	■	■	0.5	1.5	1.5	0.05			1600...
1605-1.0-2.5 L ...	1605-1.0-2.5 R ...				■	■	■	1	2.5	2.5	0.05			1600...
1605-1.5-3 L ...	1605-1.5-3 R ...				■	■	■	1.5	3	3	0.05			1600...

VALUE-LINE

1605 B-1.0-2.5 L ...	1605 B-1.0-2.5 R ...				■	■		1	2.5	2.5	0.05			1600...
1605 B-1.5-3 L ...	1605 B-1.5-3 R ...				■	■		1.5	3	3	0.05			1600...

* c: maximal turning capacity
d: maximal grooving capacity

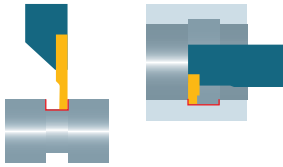

Grooving and turning



1605... CP

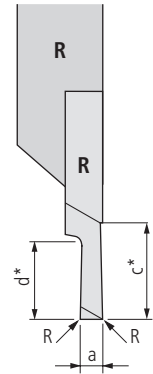
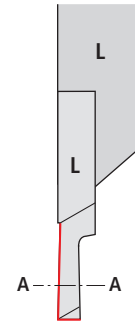
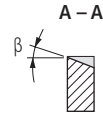

Order designation	Carbide						Dimensions					Holder
	UHM 10	UHM 10 HX	UHM 10 TX+	UHM 20	UHM 20 HPX	UHM 20 TX+	a	c*	d*	R	β	□ 80...
	-	-	●	○	●	●						
	-	●	●	○	●	●						
	○	●	●	○	○	○						
	●	○	-	●	○	-						
	-	-	●	-	-	○						

STANDARD-LINE

1605-0.8-2.5 L CP ...	1605-0.8-2.5 R CP ...				■	■	■	0.8	2.5	2.5	-	15°		1600...
1605-1.0-3.5 L CP ...	1605-1.0-3.5 R CP ...				■	■	■	1	3.5	3.5	-	15°		1600...
1605-1.0-3.5 L CP R05 ...	1605-1.0-3.5 R CP R05 ...				■	■	■	1	3.5	3.5	0.05	15°		1600...
1605-1.5-3.5 L CP ...	1605-1.5-3.5 R CP ...				■	■	■	1.5	3.5	3.5	-	15°		1600...
1605-1.5-3.5 L CP R08 ...	1605-1.5-3.5 R CP R08 ...				■	■	■	1.5	3.5	3.5	0.08	15°		1600...
1605-2.0-3.5 L CP ...	1605-2.0-3.5 R CP ...				■	■	■	2	3.5	3.5	-	15°		1600...
1605-2.0-3.5 L CP R08 ...	1605-2.0-3.5 R CP R08 ...				■	■	■	2	3.5	3.5	0.08	15°		1600...

* c: maximal turning capacity
d: maximal grooving capacity

Threading (full profile metric)

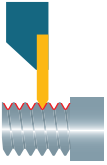

1606... VP

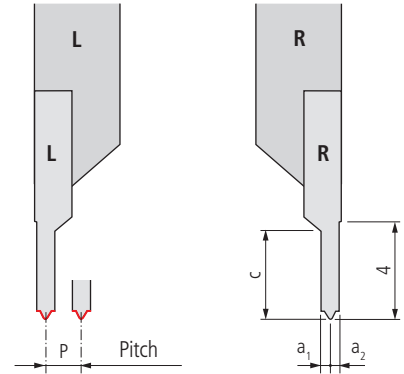
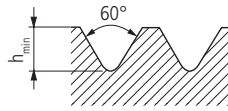

Order designation	Carbide						Standard			Dimensions					Holder □80...
	UHM 10	UHM 10 HX	UHM 10 TX+	UHM 20	UHM 20 HPX	UHM 20 TX+	ISO DIN 13	NIHS 06-03	NIHS 06-02	P	h _{min}	a ₁	a ₂	c	
L	●	●	●	●	●	●									
R	○	○	○	○	○	○									

PREMIUM-LINE

1606-0.06-60 VP L ...	1606-0.06-60 VP R ...				■	■	■	—	—	S 0.2*	0.06	0.037	0.04	0.03	—	1600...
1606-0.08-60 VP L ...	1606-0.08-60 VP R ...				■	■	■	—	—	S 0.3	0.08	0.049	0.05	0.04	—	1600...
1606-0.09-60 VP L ...	1606-0.09-60 VP R ...				■	■	■	—	—	S 0.35	0.09	0.055	0.05	0.05	—	1600...
1606-0.1-60 VP L ...	1606-0.1-60 VP R ...				■	■	■	—	—	S 0.4	0.1	0.061	0.06	0.06	—	1600...
1606-0.125-60 VP L ...	1606-0.125-60 VP R ...				■	■	■	—	—	S 0.5	0.125	0.077	0.08	0.07	—	1600...
1606-0.15-60 VP L ...	1606-0.15-60 VP R ...				■	■	■	—	—	S 0.6	0.15	0.092	0.09	0.08	—	1600...
1606-0.175-60 VP L ...	1606-0.175-60 VP R ...				■	■	■	—	—	S 0.7	0.175	0.104	0.1	0.1	—	1600...
1606-0.2-60 VP L ...	1606-0.2-60 VP R ...				■	■	■	—	—	S 0.8	0.2	0.123	0.12	0.11	—	1600...
1606-0.225-60 VP L ...	1606-0.225-60 VP R ...				■	■	■	—	—	S 0.9	0.225	0.138	0.14	0.12	—	1600...
1606-0.25-60 VP L ...	1606-0.25-60 VP R ...				■	■	■	M 1/1.2	M 1/1.2	S 1/1.2	0.25	0.153	0.15	0.14	—	1600...
1606-0.3-60 VP L ...	1606-0.3-60 VP R ...				■	■	■	—	M 1.4	S 1.4	0.3	0.184	0.18	0.17	—	1600...
1606-0.35-60 VP L ...	1606-0.35-60 VP R ...				■	■	■	M 1.6	M 1.6/1.8	—	0.35	0.215	0.21	0.19	—	1600...
1606-0.4-60 VP L ...	1606-0.4-60 VP R ...				■	■	■	M 2	M 2	—	0.4	0.245	0.24	0.22	—	1600...
1606-0.45-60 VP L ...	1606-0.45-60 VP R ...				■	■	■	M 2.5	M 2.2/2.5	—	0.45	0.276	0.27	0.25	—	1600...

STANDARD-LINE

1606-0.5-60 VP L ...	1606-0.5-60 VP R ...				■	■	■	M 3	M 3	—	0.5	0.307	0.28	0.28	1.3	1600...
1606-0.6-60 VP L ...	1606-0.6-60 VP R ...				■	■	■	—	M 3.5	—	0.6	0.368	0.33	0.33	1.5	1600...
1606-0.7-60 VP L ...	1606-0.7-60 VP R ...				■	■	■	M 4	M 4	—	0.7	0.429	0.39	0.39	1.8	1600...
1606-0.75-60 VP L ...	1606-0.75-60 VP R ...				■	■	■	—	M 4.5	—	0.75	0.46	0.41	0.41	1.9	1600...
1606-0.8-60 VP L ...	1606-0.8-60 VP R ...				■	■	■	M 5	M 5	—	0.8	0.491	0.44	0.44	2	1600...
1606-1.0-60 VP L ...	1606-1.0-60 VP R ...				■	■	■	M 6/7	—	—	1	0.613	0.55	0.55	2.5	1600...
1606-1.25-60 VP L ...	1606-1.25-60 VP R ...				■	■	■	M 8/9	—	—	1.25	0.767	0.69	0.69	3	1600...

* Similar to the norme

Recommendations for thread cutting □ 170

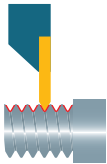

Threading (full profile UN)



1606... UN ... VP

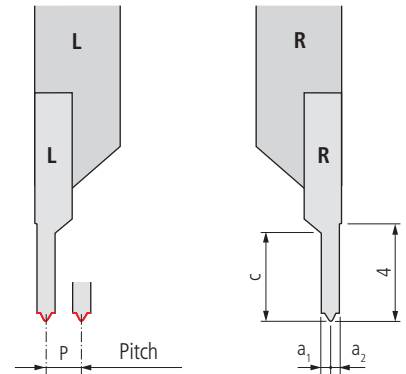
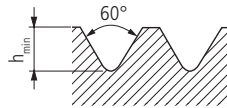

Order designation		Carbide						□ 20	Standard / thread type					Dimensions						Holder
L	R	-	-	●	○	●	○	ANSI/ASME B1.1 (Tolerance class 2A/2B/3A/3B)	P (T/Inch)	P	h _{min}	a ₁	a ₂	c	□ 80...					
		UHM 10	UHM 10 HX	UHM 10 TX+	UHM 20	UHM 20 HPX	UHM 20 TX+	UN								UNC	UNF	UNEF	UNS	UNR

PREMIUM-LINE

1606-80 UN 60 VP L ...	1606-80 UN 60 VP R ...			■	■	■		●		80	0.317	0.194	0.22	0.17	-	1600...
1606-72 UN 60 VP L ...	1606-72 UN 60 VP R ...			■	■	■		●		72	0.353	0.217	0.25	0.19	-	1600...
1606-64 UN 60 VP L ...	1606-64 UN 60 VP R ...			■	■	■		●	●	64	0.397	0.244	0.3	0.22	-	1600...
1606-56 UN 60 VP L ...	1606-56 UN 60 VP R ...			■	■	■		●	●	56	0.453	0.278	0.32	0.25	-	1600...

STANDARD-LINE

1606-48 UN 60 VP L ...	1606-48 UN 60 VP R ...			■	■	■		●	●	48	0.529	0.325	0.29	0.29	1.4	1600...
1606-44 UN 60 VP L ...	1606-44 UN 60 VP R ...			■	■	■		●		44	0.577	0.354	0.32	0.32	1.4	1600...
1606-40 UN 60 VP L ...	1606-40 UN 60 VP R ...			■	■	■		●	●	40	0.635	0.39	0.35	0.35	1.8	1600...
1606-36 UN 60 VP L ...	1606-36 UN 60 VP R ...			■	■	■		●	●	36	0.705	0.432	0.39	0.39	1.8	1600...
1606-32 UN 60 VP L ...	1606-32 UN 60 VP R ...			■	■	■		●	●	32	0.794	0.487	0.44	0.44	2	1600...
1606-28 UN 60 VP L ...	1606-28 UN 60 VP R ...			■	■	■		●	●	28	0.907	0.556	0.5	0.5	2.2	1600...
1606-24 UN 60 VP L ...	1606-24 UN 60 VP R ...			■	■	■		●	●	24	1.058	0.649	0.58	0.58	2.2	1600...
1606-20 UN 60 VP L ...	1606-20 UN 60 VP R ...			■	■	■	●	●	●	20	1.27	0.779	0.7	0.7	2.9	1600...

Recommendations for thread cutting □ 170

Threading (full profile pipe thread)

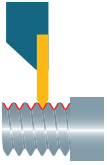

1606-G ...VP

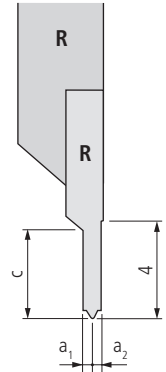
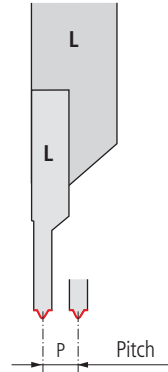
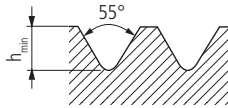

Order designation		Carbide						□ 20	Standard	Dimensions						Holder
L	R	UHM 10	UHM 10 HX	UHM 10 TX+	UHM 20	UHM 20 HPX	UHM 20 TX+	ANSI B1.1	P (T/Inch)	P	h _{min}	a ₁	a ₂	c	□ 80...	
-	-	●	●	●	○	○	○									
○	○	●	●	●	○	○	○									
●	○	-	-	-	●	○	-									
-	-	●	-	●	-	○	○									

STANDARD-LINE

1606-G 28-55 VP L ...	1606-G 28-55 VP R ...				■	■	■	1/8	28	0.907	0.581	0.5	0.5	2.3	1600...
								1/16	28	0.907	0.581	0.5	0.5	2.3	1600...
1606-G 19-55 VP L ...	1606-G 19-55 VP R ...				■	■	■	1/4	19	1.337	0.856	0.74	0.74	3.3	1600...
								3/8	19	1.337	0.856	0.74	0.74	3.3	1600...
								1/2	14	1.814	1.162	1	1	4	1600...
1606-G 14-55 VP L ...	1606-G 14-55 VP R ...				■	■	■	5/8	14	1.814	1.162	1	1	4	1600...
								3/4	14	1.814	1.162	1	1	4	1600...
								7/8	14	1.814	1.162	1	1	4	1600...

Recommendations for thread cutting □ 170

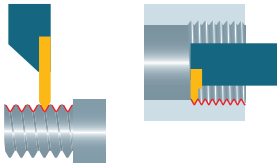

Threading (partial profile 55°/60°)



1606...

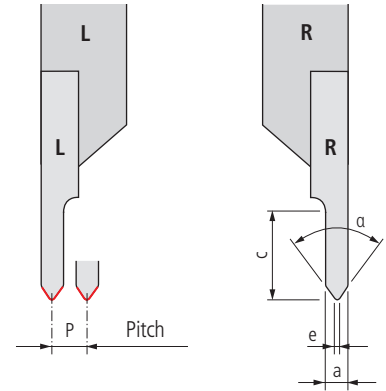

Order designation	Carbide						Dimensions					Holder
	-	-	●	○	●	●	P	a	c	α	e	□ 80...
L	UHM 10	UHM 10 HX	UHM 10 TX+	UHM 20	UHM 20 HPX	UHM 20 TX+						
R												

STANDARD-LINE

1606-2-4-55 L ...	1606-2-4-55 R ...				■	■	■	0.25-2	2	4	55°	0.035		1600...
1606-2-4-60 L ...	1606-2-4-60 R ...				■	■	■	0.25-2	2	4	60°	0.035		1600...

VALUE-LINE

1606 B-2-4-55 L ...	1606 B-2-4-55 R ...				■	■		0.25-2	2	4	55°	0.035		1600...
1606 B-2-4-60 L ...	1606 B-2-4-60 R ...				■	■		0.25-2	2	4	60°	0.035		1600...

Recommendations for thread cutting □ 170

Threading (full profile for implants in surgical-reconstructive medicine)

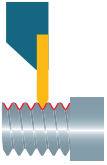

1606 HA... VP ...

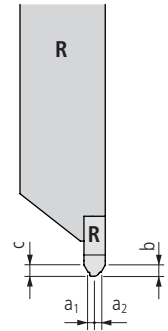
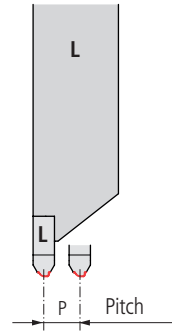
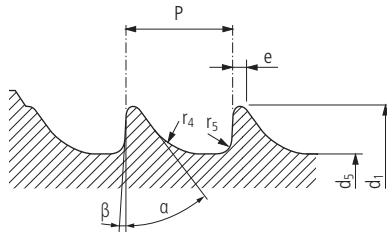

Order designation	Carbide □20						Standard	Dimensions										Holder □80...
	UHM 10	UHM 10 HX	UHM 10 TX+	UHM 20	UHM 20 HPX	UHM 20 TX+		P	a ₁	a ₂	α	β	d ₁	d ₅	Tolerance	e	r ₄	
L	●	●	●	●	●	●	ISO 5835							0/-0.15				
R	●	●	●	●	●	●												

STANDARD-LINE

1606 HA1.5 VP L ...	1606 HA1.5 VP R ...				■	■	■	HA1.5	0.5	0.4	0.4	35°	3°	1.5	1.1	0/-0.1	0.1	0.3	0.1	1600...
1606 HA2.0 VP L ...	1606 HA2.0 VP R ...				■	■	■	HA2.0	0.6	0.45	0.45	35°	3°	2	1.3	0/-0.1	0.1	0.4	0.1	1600...
1606 HA2.7 VP L ...	1606 HA2.7 VP R ...				■	■	■	HA2.7	1	0.65	0.65	35°	3°	2.7	1.9	0/-0.15	0.1	0.6	0.2	1600...
1606 HA3.5 VP L ...	1606 HA3.5 VP R ...				■	■	■	HA3.5	1.25	0.78	0.78	35°	3°	3.5	2.4	0/-0.15	0.1	0.8	0.2	1600...
1606 HA4.0 VP L ...	1606 HA4.0 VP R ...				■	■	■	HA4.0	1.5	0.9	0.9	35°	3°	4	2.9	0/-0.15	0.1	0.8	0.2	1600...
1606 HA4.5 VP L ...	1606 HA4.5 VP R ...				■	■	■	HA4.5	1.75	1.03	1.03	35°	3°	4.5	3	0/-0.15	0.1	1	0.3	1600...
1606 HA5.0 VP L ...	1606 HA5.0 VP R ...				■	■	■	HA5.0	1.75	1.03	1.03	35°	3°	5	3.5	0/-0.15	0.1	1	0.3	1600...

1606 HB... VP ...

Order designation	Carbide □20						Standard	Dimensions										Holder □80...
	UHM 10	UHM 10 HX	UHM 10 TX+	UHM 20	UHM 20 HPX	UHM 20 TX+		P	a ₁	a ₂	α	β	d ₁	d ₅	Tolerance	e	r ₄	
L	●	●	●	●	●	●	ISO 5835							0/-0.15				
R	●	●	●	●	●	●												

STANDARD-LINE

1606 HB4.0 VP L ...	1606 HB4.0 VP R ...				■	■	■	HB4.0	1.75	1.03	1.03	25°	5°	4	1.9	0/-0.15	0.1	0.8	0.3	1600...
1606 HB6.5 VP L ...	1606 HB6.5 VP R ...				■	■	■	HB4.5	2.75	1.58	1.58	25°	5°	6.5	3	0/-0.15	0.2	1.2	0.8	1600...-4

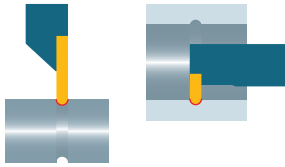

Radius-grooving



1607...

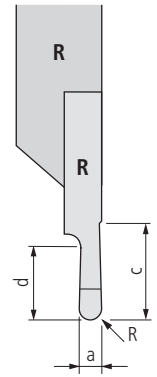
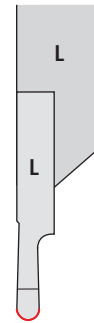
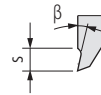

Order designation	Carbide						Dimensions						Holder
	-	-	●	○	●	●	a	c	d	β	R	s	□ 80...
L	UHM 10	UHM 10 HX	UHM 10 TX+	UHM 20	UHM 20 HPX	UHM 20 TX+							
R													

PREMIUM-LINE

1607-R0.25-2 L ...	1607-R0.25-2 R ...				■	■	■	0.5	5	2	6°	0.25	2	1600...
--------------------	--------------------	--	--	--	---	---	---	-----	---	---	----	------	---	---------

STANDARD-LINE

1607-R0.4-2.5 L ...	1607-R0.4-2.5 R ...				■	■	■	0.8	5	2.5	6°	0.4	2	1600...
1607-R0.5-2.5 L ...	1607-R0.5-2.5 R ...				■	■	■	1	5	2.5	6°	0.5	2	1600...
1607-R0.6-2.5 L ...	1607-R0.6-2.5 R ...				■	■	■	1.2	5	2.5	6°	0.6	2	1600...
1607-R0.75-3.0 L ...	1607-R0.75-3.0 R ...				■	■	■	1.5	5	3	6°	0.75	2	1600...
1607-R0.8-3.0 L ...	1607-R0.8-3.0 R ...				■	■	■	1.6	5	3	6°	0.8	2	1600...
1607-R1.0-4.0 L ...	1607-R1.0-4.0 R ...				■	■	■	2	5	4	6°	1	2	1600...
1607-R1.5-4.0 L ...	1607-R1.5-4.0 R ...				■	■	■	3	5	4	6°	1.5	2	1600...



Grooving (radial)

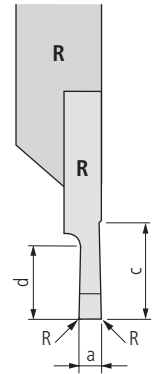
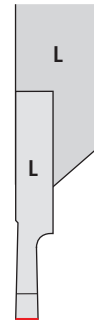

1610...

Order designation	Carbide						Standard	Dimensions						Holder □80...
	UHM 10	UHM 10 HX	UHM 10 TX+	UHM 20	UHM 20 HPX	UHM 20 TX+		a	R	c	d	β	s	
L	-	-	●	○	●	●	ISO DIN	a	R	c	d	β	s	Holder □80...
R	○	●	-	○	●	●								

PREMIUM-LINE

1610-0.05-0.1 L ...	1610-0.05-0.1 R ...				■	■	■	-	0.05 ±0.01	-	5	0.1	6°	1	1600...
1610-0.1-0.2 L ...	1610-0.1-0.2 R ...				■	■	■	-	0.1 ±0.01	-	5	0.2	6°	1	1600...
1610-0.15-0.3 L ...	1610-0.15-0.3 R ...				■	■	■	-	0.15 ±0.01	-	5	0.3	6°	1	1600...

STANDARD-LINE

1610-0.24-0.5 L ...	1610-0.24-0.5 R ...				■	■	■	6799	0.24 +0.04/0	-	5	0.5	10°	3	1600...
1610-0.3-0.6 L ...	1610-0.3-0.6 R ...				■	■	■	-	0.3 ±0.02	-	5	0.6	6°	1	1600...
1610-0.34-0.6 L ...	1610-0.34-0.6 R ...				■	■	■	6799	0.34 +0.04/0	-	5	0.6	10°	3	1600...
1610-0.4-0.8 L ...	1610-0.4-0.8 R ...				■	■	■	-	0.4 ±0.02	-	5	0.8	6°	1	1600...
1610-0.44-0.8 L ...	1610-0.44-0.8 R ...				■	■	■	6799	0.44 +0.04/0	-	5	0.8	10°	3	1600...
1610-0.45-1.5 L ...	1610-0.45-1.5 R ...				■	■	■	-	0.45 ±0.02	-	5	1.5	6°	1	1600...
1610-0.5-1.0 L ...	1610-0.5-1.0 R ...				■	■	■	-	0.5 ±0.02	-	5	1	6°	1	1600...
1610-0.54-0.8 L ...	1610-0.54-0.8 R ...				■	■	■	6799	0.54 +0.05/0	-	5	0.8	10°	3	1600...
1610-0.6-1.2 L ...	1610-0.6-1.2 R ...				■	■	■	-	0.6 ±0.02	-	5	1.2	6°	1	1600...
1610-0.64-1.0 L ...	1610-0.64-1.0 R ...				■	■	■	6799	0.64 +0.05/0	-	5	1	10°	3	1600...
1610-0.64-1.2 L ...	1610-0.64-1.2 R ...				■	■	■	6799	0.64 +0.05/0	-	5	1.2	10°	3	1600...
1610-0.65-0.7 L ...	1610-0.65-0.7 R ...				■	■	■	471	0.65 ±0.02	-	5	0.7	10°	3	1600...
1610-0.7-1.4 L ...	1610-0.7-1.4 R ...				■	■	■	-	0.7 ±0.02	-	5	1.4	6°	1	1600...
1610-0.74-1.8 L ...	1610-0.74-1.8 R ...				■	■	■	6799	0.74 +0.05/0	-	5	1.8	10°	3	1600...
1610-0.85-0.9 L ...	1610-0.85-0.9 R ...				■	■	■	471	0.85 ±0.02	-	5	0.9	10°	3	1600...
1610-0.85-1.2 L ...	1610-0.85-1.2 R ...				■	■	■	-	0.85 ±0.02	-	5	1.2	10°	3	1600...
1610-0.94-2.3 L ...	1610-0.94-2.3 R ...				■	■	■	6799	0.94 +0.05/0	-	5	2.3	10°	3	1600...
1610-0.95-1.0 L ...	1610-0.95-1.0 R ...				■	■	■	471	0.95 ±0.02	-	5	1	10°	3	1600...
1610-1.0-1.14 L ...	1610-1.0-1.14 R ...				■	■	■	471	1 ±0.02	-	5	1.14	10°	3	1600...
1610-1.05-2.3 L ...	1610-1.05-2.3 R ...				■	■	■	6799	1.05 +0.08/0	-	5	2.3	10°	3	1600...
1610-1.15-2.8 L ...	1610-1.15-2.8 R ...				■	■	■	6799	1.15 +0.08/0	-	5	2.8	10°	3	1600...
1610-1.2-1.34 L ...	1610-1.2-1.34 R ...				■	■	■	471/472	1.2 ±0.02	-	5	1.34	10°	3	1600...
1610-1.25-2.8 L ...	1610-1.25-2.8 R ...				■	■	■	6799	1.25 +0.08/0	-	5	2.8	10°	3	1600...
1610-1.35-3.3 L ...	1610-1.35-3.3 R ...				■	■	■	6799	1.35 +0.08/0	-	5	3.3	10°	3	1600...
1610-1.4-1.53 L ...	1610-1.4-1.53 R ...				■	■	■	471/472	1.4 ±0.02	-	5	1.53	10°	3	1600...
1610-1.5-3.0 L ...	1610-1.5-3.0 R ...				■	■	■	-	1.5 ±0.02	-	5	3	10°	3	1600...
1610-1.55-3.8 L ...	1610-1.55-3.8 R ...				■	■	■	6799	1.55 +0.08/0	-	5	3.8	10°	3	1600...
1610-1.7-1.82 L ...	1610-1.7-1.82 R ...				■	■	■	471/472	1.7 ±0.02	-	5	1.82	10°	3	1600...
1610-1.95-2.0 L ...	1610-1.95-2.0 R ...				■	■	■	471/472	1.95 ±0.02	-	5	2	10°	3	1600...
1610-2.25-2.0 L ...	1610-2.25-2.0 R ...				■	■	■	471/472	2.25 ±0.02	-	5	2	10°	3	1600...
1610-2.75-2.0 L ...	1610-2.75-2.0 R ...				■	■	■	471/472	2.75 ±0.02	-	5	2	10°	3	1600...



Grooving (axial)



1611...

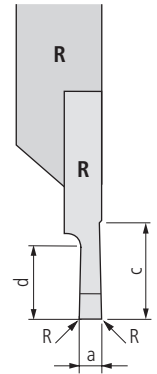
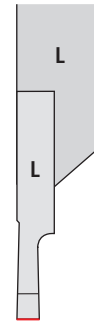
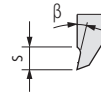

Order designation	Carbide						Dimensions							Holder
	-	-	●	○	●	●	a	R	c	D _{min}	d	β	s	□ 80...
L	-	-	●	○	●	●	±0.02							
R	-	○	-	-	○	○								
	UHM 10	UHM 10 HX	UHM 10 TX+	UHM 20	UHM 20 HPX	UHM 20 TX+								

STANDARD-LINE

1611-0.5-1.0 L ...	1611-0.5-1.0 R ...				■	■	■	0.5	0.05	4	7	1	8°	1.2	1600...
1611-0.6-1.2 L ...	1611-0.6-1.2 R ...				■	■	■	0.6	0.05	4	8	1.2	8°	1.2	1600...
1611-0.8-1.5 L ...	1611-0.8-1.5 R ...				■	■	■	0.8	0.05	4	8	1.5	8°	1.2	1600...
1611-1.0-2.0 L ...	1611-1.0-2.0 R ...				■	■	■	1	0.05	4	8	2	8°	1.2	1600...
1611-1.5-2.5 L ...	1611-1.5-2.5 R ...				■	■	■	1.5	0.05	4	14	2.5	8°	1.2	1600...
1611-2.0-3.0 L ...	1611-2.0-3.0 R ...				■	■	■	2	0.05	4	18	3	8°	1.2	1600...
1611-2.5-3.5 L ...	1611-2.5-3.5 R ...				■	■	■	2.5	0.05	4	18	3.5	8°	1.2	1600...

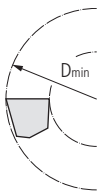

Attention
The groove must not be made underneath the D_{min}-position.

Pay attention to the "working situations" for the correct selection of the combinations of tools and inserts □ 26...

Miniature grooving (axial)

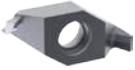
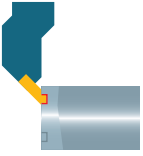

1611-45...

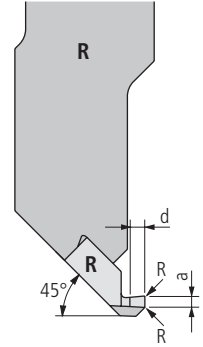

Order designation		Carbide						Dimensions						Holder
L	R	-	-	●	○	○	○	a	R	D _{min}	d	β	s	91
		○	●	●	●	●	●							
		○	○	-	○	○	○	±0.01						
		-	-	●	○	○	○							
		○	○	-	○	○	○							
		○	○	-	○	○	○							
		○	○	-	○	○	○							
PREMIUM-LINE														
1611-45-0.25-0.5 L ...	1611-45-0.25-0.5 R ...				■	■	■	0.25	-	0.8	0.5	8°	0.5	1600... 45 STA
1611-45-0.5-1.0 L ...	1611-45-0.5-1.0 R ...				■	■	■	0.5	-	1.6	1	8°	1	1600... 45 STA
1611-45-0.75-1.5 L ...	1611-45-0.75-1.5 R ...				■	■	■	0.75	-	2.4	1.5	8°	1.5	1600... 45 STA
1611-45-1.0-2.0 L ...	1611-45-1.0-2.0 R ...				■	■	■	1	-	3.2	2	8°	2	1600... 45 STA

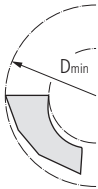

Attention
The first groove must be made exactly on the D_{min}-position.

Pay attention to the "working situations" for the correct selection of the combinations of tools and inserts 26...

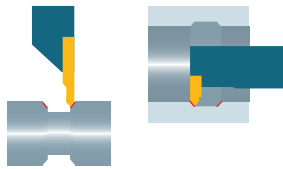

Chamfering



1612...

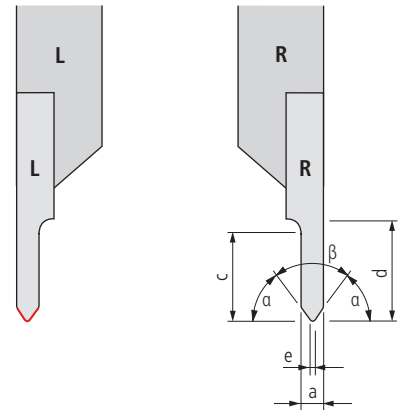

Order designation		Carbide						Dimensions							Holder
L	R	-	-	●	○	●	●	a	c	d	α	β	e	□80...	
		-	●	●	○	●	●								
		○	●	●	○	●	●								
		●	○	-	●	○	-								
		-	-	●	-	-	○								
		-	-	●	-	-	○								
UHM 10	UHM 10 HX	UHM 10 TX+	UHM 20	UHM 20 HPX	UHM 20 TX+										

STANDARD-LINE

1612-1-4-45 L ...	1612-1-4-45 R ...				■	■	■	1	4	4	45°	90°	-	1600...
1612-2-4-60 L ...	1612-2-4-60 R ...				■	■	■	2	4	4	60°	60°	0.035	1600...

80

UTILIS **multidec**® swiss type tools

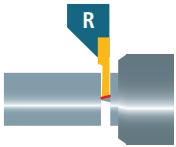

Standard

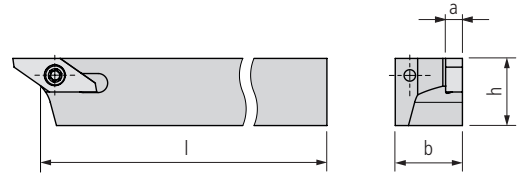

1600...

Order designation		Dimensions								Inserts
L	R	h	b	l	a					□51...

STANDARD-LINE

1600-07x100 L	■	1600-07x100 R	■	7	7	100	3					16...
1600-08x80 L	■	1600-08x80 R	■	8	8	80	3					16...
1600-08x100 L	■	1600-08x100 R	■	8	8	100	3					16...
1600-10x80 L	■	1600-10x80 R	■	10	10	80	3					16...
1600-10x100 L	■	1600-10x100 R	■	10	10	100	3					16...
1600-12x100 L	■	1600-12x100 R	■	12	12	100	3					16...
1600-16x125 L	■	1600-16x125 R	■	16	16	125	3					16...
1600-20x125 L	■	1600-20x125 R	■	20	20	125	3					16...
1600-25x125 L	■	1600-25x125 R	■	25	25	125	3					16...

VALUE-LINE

1600 B-10x100 L	■	1600 B-10x100 R	■	10	10	100	3					16...
1600 B-12x100 L	■	1600 B-12x100 R	■	12	12	100	3					16...
1600 B-16x125 L	■	1600 B-16x125 R	■	16	16	125	3					16...

1600... INCH

Order designation		Dimensions								Inserts
L	R	h	b	l	a					□51...

STANDARD-LINE

1600-3/8"x80 L	■	1600-3/8"x80 R	■	9.525	9.525	80	3					16...
1600-3/8"x100 L	■	1600-3/8"x100 R	■	9.525	9.525	100	3					16...
1600-1/2"x100 L	■	1600-1/2"x100 R	■	12.7	12.7	100	3					16...
1600-5/8"x125 L	■	1600-5/8"x125 R	■	15.875	15.875	125	3					16...
1600-3/4"x125 L	■	1600-3/4"x125 R	■	19.05	19.05	125	3					16...

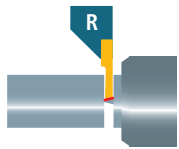

With internal cooling

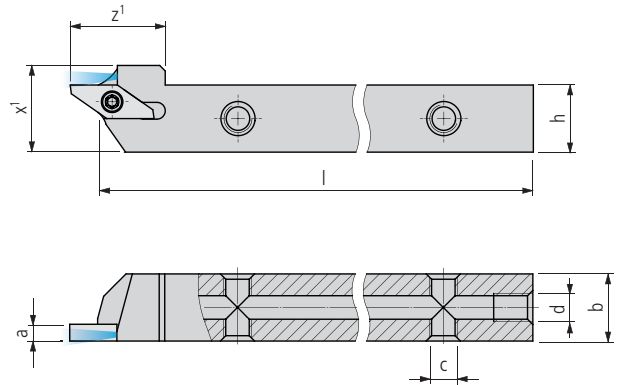

1600... IC

Order designation		Dimensions										Inserts
L	R	h	b	l	a	z¹	x¹	c	d	□ 51...		

PREMIUM-LINE

1600-08x100 L IC	■	1600-08x100 R IC	■	8	10	100	3	15	11.5	M5	M5	16...
1600-10x100 L IC	■	1600-10x100 R IC	■	10	10	100	3	15	13.5	M5	M5	16...
1600-12x100 L IC	■	1600-12x100 R IC	■	12	12	100	3	17	15.5	M5	M5	16...
1600-16x125 L IC	■	1600-16x125 R IC	■	16	16	125	3	17	19.5	M5	G½"	16...
1600-20x125 L IC	■	1600-20x125 R IC	■	20	20	125	3	20	23.5	M5	G½"	16...

1600... IC INCH

Order designation		Dimensions										Inserts
L	R	h	b	l	a	z¹	x¹	c	d	□ 51...		

PREMIUM-LINE

1600-3/8"x100 L IC	■	1600-3/8"x100 R IC	■	9.525	9.525	100	3	15	13	M5	M5	16...
1600-1/2"x100 L IC	■	1600-1/2"x100 R IC	■	12.7	12.7	100	3	17	16.2	M5	M5	16...
1600-5/8"x125 L IC	■	1600-5/8"x125 R IC	■	15.875	15.875	125	3	17	19.4	M5	G½"	16...
1600-3/4"x125 L IC	■	1600-3/4"x125 R IC	■	19.05	19.05	125	3	20	22.6	M5	G½"	16...

Scope of delivery: Holder without coolant connector

Coolant system □ 619...

For 4 mm and 6 mm wide inserts

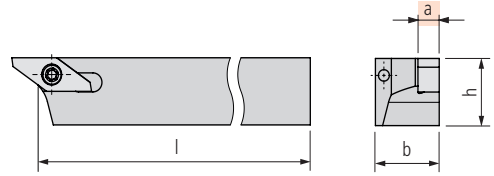
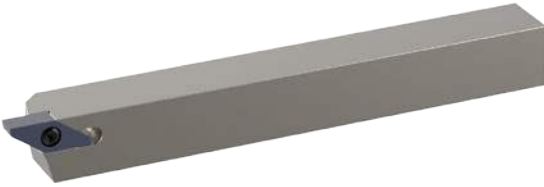
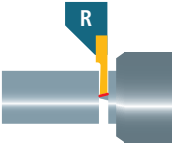

1600...-4

Order designation		Dimensions						Inserts
L	R	h	b	l	a			□ 600...

STANDARD-LINE

1600-08x80-4 L	■	1600-08x80-4 R	■	8	8	80	4					16...
1600-08x100-4 L	■	1600-08x100-4 R	■	8	8	100	4					16...
1600-10x80-4 L	■	1600-10x80-4 R	■	10	10	80	4					16...
1600-10x100-4 L	■	1600-10x100-4 R	■	10	10	100	4					16...
1600-12x100-4 L	■	1600-12x100-4 R	■	12	12	100	4					16...
1600-16x125-4 L	■	1600-16x125-4 R	■	16	16	125	4					16...
1600-20x125-4 L	■	1600-20x125-4 R	■	20	20	125	4					16...
1600-25x125-4 L	■	1600-25x125-4 R	■	25	25	125	4					16...

1600...-6

Order designation		Dimensions						Inserts
L	R	h	b	l	a			□ 600...

STANDARD-LINE

1600-10x80-6 L	■	1600-10x80-6 R	■	10	10	80	6					16...
1600-10x100-6 L	■	1600-10x100-6 R	■	10	10	100	6					16...
1600-12x100-6 L	■	1600-12x100-6 R	■	12	12	100	6					16...
1600-16x125-6 L	■	1600-16x125-6 R	■	16	16	125	6					16...
1600-20x125-6 L	■	1600-20x125-6 R	■	20	20	125	6					16...
1600-25x125-6 L	■	1600-25x125-6 R	■	25	25	125	6					16...

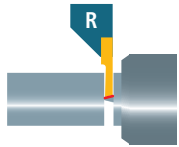

For 8 mm wide inserts

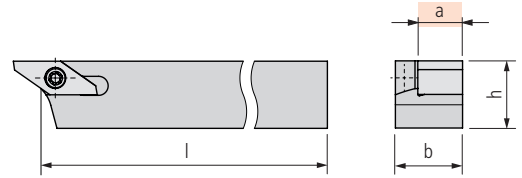
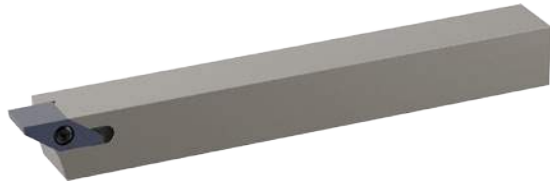

1600...-8

Order designation		Dimensions								Inserts
L	R	h	b	l	a					□ 600...

STANDARD-LINE

1600-12x100-8 L	■	1600-12x100-8 R	■	12	12	100	8				16...
1600-16x125-8 L	■	1600-16x125-8 R	■	16	16	125	8				16...
1600-20x125-8 L	■	1600-20x125-8 R	■	20	20	125	8				16...
1600-25x125-8 L	■	1600-25x125-8 R	■	25	25	125	8				16...

With off-set shank and insert

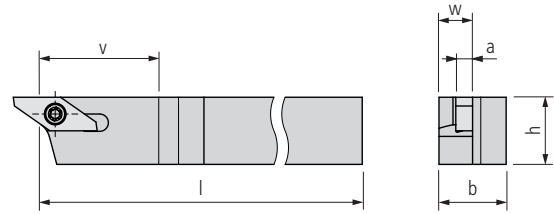
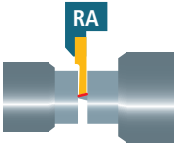

1600... A

Order designation		Dimensions										Inserts
L	R	h	b	l	v	w	a					□51...

STANDARD-LINE

1600-08x80 LA	■	1600-08x80 RA	■	8	8	80	21	6	3			16...
1600-08x100 LA	■	1600-08x100 RA	■	8	8	100	21	6	3			16...
1600-10x80 LA	■	1600-10x80 RA	■	10	10	80	21	6	3			16...
1600-10x100 LA	■	1600-10x100 RA	■	10	10	100	21	6	3			16...
1600-12x100 LA	■	1600-12x100 RA	■	12	12	100	21	6	3			16...
1600-16x125 LA	■	1600-16x125 RA	■	16	16	125	21	6	3			16...

1600... A INCH

Order designation		Dimensions										Inserts
L	R	h	b	l	v	w	a					□51...

STANDARD-LINE

1600-3/8"x80 LA	■	1600-3/8"x80 RA	■	9.525	9.525	80	21	6	3			16...
1600-3/8"x100 LA	■	1600-3/8"x100 RA	■	9.525	9.525	100	21	6	3			16...
1600-1/2"x100 LA	■	1600-1/2"x100 RA	■	12.7	12.7	100	21	6	3			16...
1600-5/8"x125 LA	■	1600-5/8"x125 RA	■	15.875	15.875	125	21	6	3			16...

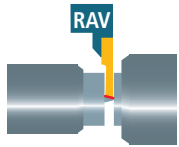

With off-set shank

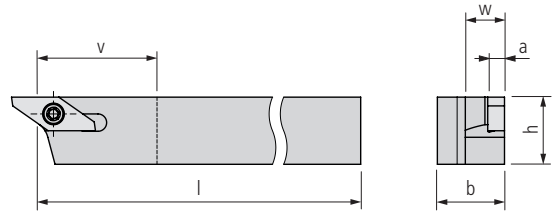

1600... AV

Order designation		Dimensions								Inserts
L	R	h	b	l	v	w	a			□ 51...

STANDARD-LINE

1600-08x80 LAV	■	1600-08x80 RAV	■	8	8	80	21	6	3		16...
1600-08x100 LAV	■	1600-08x100 RAV	■	8	8	100	21	6	3		16...
1600-10x80 LAV	■	1600-10x80 RAV	■	10	10	80	21	6	3		16...
1600-10x100 LAV	■	1600-10x100 RAV	■	10	10	100	21	6	3		16...
1600-12x100 LAV	■	1600-12x100 RAV	■	12	12	100	21	6	3		16...
1600-16x125 LAV	■	1600-16x125 RAV	■	16	16	125	21	6	3		16...

1600... AV INCH

Order designation		Dimensions								Inserts
L	R	h	b	l	v	w	a			□ 51...

STANDARD-LINE

1600-3/8"x80 LAV	■	1600-3/8"x80 RAV	■	9.525	9.525	80	21	6	3		16...
1600-3/8"x100 LAV	■	1600-3/8"x100 RAV	■	9.525	9.525	100	21	6	3		16...
1600-1/2"x100 LAV	■	1600-1/2"x100 RAV	■	12.7	12.7	100	21	6	3		16...
1600-5/8"x125 LAV	■	1600-5/8"x125 RAV	■	15.875	15.875	125	21	6	3		16...

"TWIN" version

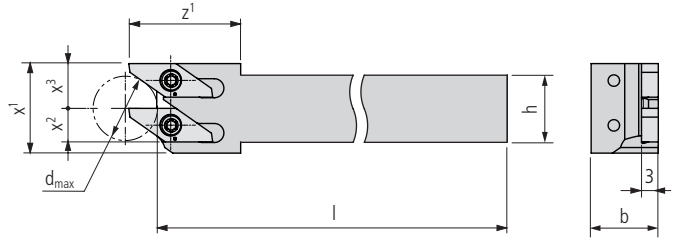
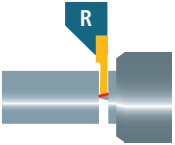

1600/1600... TWIN

Order designation		Dimensions									Inserts	
L	L	R	R	h	b	l	z ¹	x ¹	x ²	x ³	d _{max}	□ 51...

STANDARD-LINE

1600L/1600L-0810x100 Twin	■	1600R/1600R-0810x100 Twin	■	8	10	100	20	16	4	8	11.5	16...
1600L/1600L-10x100 Twin	■	1600R/1600R-10x100 Twin	■	10	10	100	20	16	5	8	11.5	16...
1600L/1600L-12x100 Twin	■	1600R/1600R-12x100 Twin	■	12	12	100	20	16	6	8	11.5	16...
1600L/1600L-16x125 Twin	■	1600R/1600R-16x125 Twin	■	16	16	125	20	20	8	10	19	16...
1600L/1600L-20x125 Twin	■	1600R/1600R-20x125 Twin	■	20	20	125	20	24	8	14	34	16...

1600/1600... TWIN INCH

Order designation		Dimensions									Inserts	
L	L	R	R	h	b	l	z ¹	x ¹	x ²	x ³	d _{max}	□ 51...

STANDARD-LINE

1600L/1600L-3/8"x100 Twin	■	1600R/1600R-3/8"x100 Twin	■	9.525	9.525	100	20	16	5	8	11.5	16...
1600L/1600L-1/2"x100 Twin	■	1600R/1600R-1/2"x100 Twin	■	12.7	12.7	100	20	16	6	8	11.5	16...
1600L/1600L-5/8"x125 Twin	■	1600R/1600R-5/8"x125 Twin	■	15.875	15.875	125	20	20	8	10	19	16...
1600L/1600L-3/4"x125 Twin	■	1600R/1600R-3/4"x125 Twin	■	19.05	19.05	125	20	24	7	14	34	16...

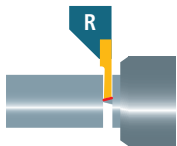

"TWIN" version with internal cooling

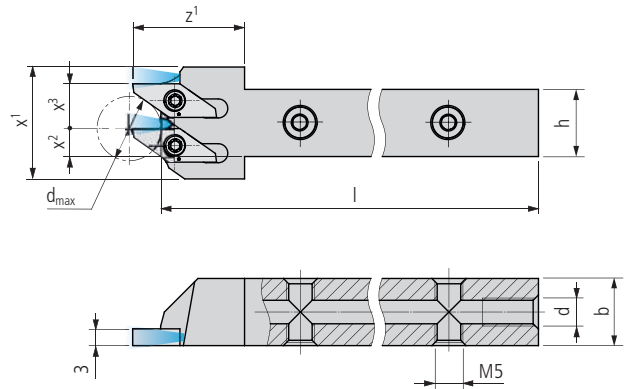

1600/1600... TWIN IC

Order designation		Dimensions										Inserts	
L	L	R	R	h	b	l	z ¹	x ¹	x ²	x ³	d	d _{max}	□ 51...
PREMIUM-LINE													
1600L/1600L-0812x100 Twin IC	■	1600R/1600R-0812x100 Twin IC	■	8	12	100	20	20	3	8	M5	11.5	16...
1600L/1600L-1012x100 Twin IC	■	1600R/1600R-1012x100 Twin IC	■	10	12	100	20	20	4	8	M5	11.5	16...
1600L/1600L-12x100 Twin IC	■	1600R/1600R-12x100 Twin IC	■	12	12	100	20	20	5	8	M5	11.5	16...
1600L/1600L-16x125 Twin IC	■	1600R/1600R-16x125 Twin IC	■	16	16	125	20	24	7	10	G ¹ / ₈ "	19	16...
1600L/1600L-20x125 Twin IC	■	1600R/1600R-20x125 Twin IC	■	20	20	125	20	28	7	14	G ¹ / ₈ "	34	16...

1600/1600... TWIN IC INCH

Order designation		Dimensions										Inserts	
L	L	R	R	h	b	l	z ¹	x ¹	x ²	x ³	d	d _{max}	□ 51...
PREMIUM-LINE													
1600L/1600L-3/8"12x100 Twin IC	■	1600R/1600R-3/8"12x100 Twin IC	■	9.525	12	100	20	20	4	8	M5	11.5	16...
1600L/1600L-1/2"x100 Twin IC	■	1600R/1600R-1/2"x100 Twin IC	■	12.7	12.7	100	20	20	6	8	M5	11.5	16...
1600L/1600L-5/8"x125 Twin IC	■	1600R/1600R-5/8"x125 Twin IC	■	15.875	15.875	125	20	24	7	10	G ¹ / ₈ "	19	16...
1600L/1600L-3/4"x125 Twin IC	■	1600R/1600R-3/4"x125 Twin IC	■	19.05	19.05	125	20	28	6	14	G ¹ / ₈ "	34	16...

Scope of delivery: Holder without coolant connector
 Coolant system □ 619...

"Y-AXIS" version with internal cooling

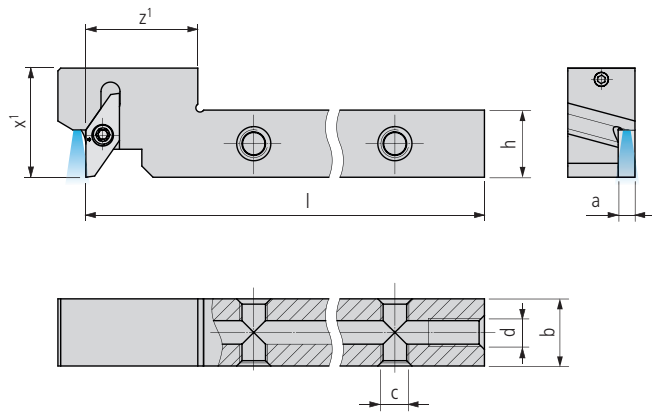
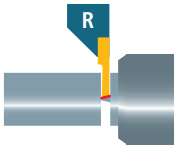

1600 YA... IC

Order designation		Dimensions										Inserts
L	R	h	b	l	a	z¹	x¹	c	d	□51...		

PREMIUM-LINE

		1600 YA-12x100-20 R IC	■	12	12	100	3	20	19.5	M5	M5	16...
		1600 YA-12x100-25 R IC	■	12	12	100	3	25	19.5	M5	M5	16...
		1600 YA-12x100-30 R IC	■	12	12	100	3	30	19.5	M5	M5	16...
		1600 YA-16x125-20 R IC	■	16	16	125	3	20	19.5	M5	G½	16...
		1600 YA-16x125-25 R IC	■	16	16	125	3	25	19.5	M5	G½	16...
		1600 YA-16x125-30 R IC	■	16	16	125	3	30	19.5	M5	G½	16...

1600 YA... IC INCH

Order designation		Dimensions										Inserts
L	R	h	b	l	a	z¹	x¹	c	d	□51...		

PREMIUM-LINE

		1600 YA-1/2"x100-20 R IC	■	12.7	12.7	100	3	20	19.5	M5	M5	16...
		1600 YA-1/2"x100-25 R IC	■	12.7	12.7	100	3	25	19.5	M5	M5	16...
		1600 YA-1/2"x100-30 R IC	■	12.7	12.7	100	3	30	19.5	M5	M5	16...
		1600 YA-5/8"x125-20 R IC	■	15.875	15.875	125	3	20	19.5	M5	G½	16...
		1600 YA-5/8"x125-25 R IC	■	15.875	15.875	125	3	25	19.5	M5	G½	16...
		1600 YA-5/8"x125-30 R IC	■	15.875	15.875	125	3	30	19.5	M5	G½	16...

Usage notes:

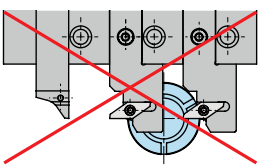

To avoid problems, two Y-AXIS holders must not be mounted directly next to each other. Mount a standard tool holder between the Y-AXIS holders.

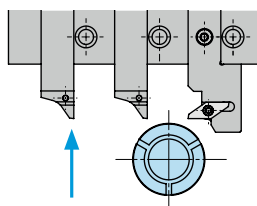

To prevent collisions, move back the holder in accordance with the overhanging length before changing the tool position.

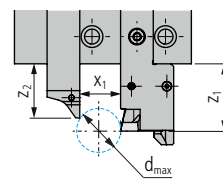

$$d_{\max} = \frac{(z_1 - z_2)^2 + x_1^2}{x_1}$$

Scope of delivery: Holder without coolant connector
 Coolant system □ 619...

Legend □ 8...

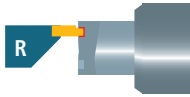

With round shank

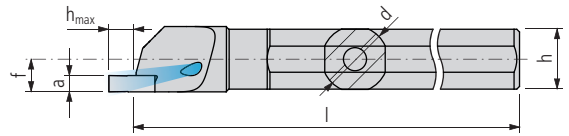

1600... 00 RD . IC

Order designation		Dimensions							Inserts
L	R	d	l	h _{max}	a	h	f		□ 51...

STANDARD-LINE

1600-12x125 00 RD L IC	■	1600-12x125 00 RD R IC	■	12	125	5	3	11	6		16...
1600-16x125 00 RD L IC	■	1600-16x125 00 RD R IC	■	16	125	5	3	15	8		16...
1600-20x125 00 RD L IC	■	1600-20x125 00 RD R IC	■	20	125	5	3	19	10		16...
1600-22x125 00 RD L IC	■	1600-22x125 00 RD R IC	■	22	125	5	3	21	11		16...

1600... 00 RD . IC INCH

Order designation		Dimensions							Inserts
L	R	d	l	h _{max}	a	h	f		□ 51...

STANDARD-LINE

1600-3/4"x125 00 RD L IC	■	1600-3/4"x125 00 RD R IC	■	19.05	125	5	3	18	9.53		16...
--------------------------	---	--------------------------	---	-------	-----	---	---	----	------	--	-------

90

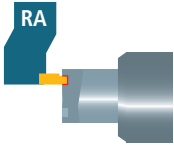

With off-set shank

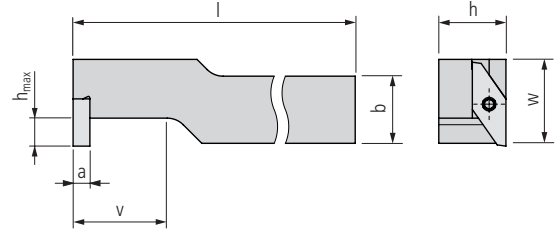

1600... 90 ST A

Order designation		Dimensions									Inserts*
L	R	h	b	l	v	w	h _{max}	a			□ 77...

STANDARD-LINE

1600-08x80 90 ST LA	■	1600-08x80 90 ST RA	■	8	8	80	17	15	5	3	1611...
1600-08x100 90 ST LA	■	1600-08x100 90 ST RA	■	8	8	100	17	15	5	3	1611...
1600-10x80 90 ST LA	■	1600-10x80 90 ST RA	■	10	10	80	17	15	5	3	1611...
1600-10x100 90 ST LA	■	1600-10x100 90 ST RA	■	10	10	100	17	15	5	3	1611...
1600-12x100 90 ST LA	■	1600-12x100 90 ST RA	■	12	12	100	17	15	5	3	1611...
1600-16x125 90 ST LA	■	1600-16x125 90 ST RA	■	16	16	125	17	16	5	3	1611...
1600-20x125 90 ST LA	■	1600-20x125 90 ST RA	■	20	20	125	17	20	5	3	1611...

1600... 90 ST A INCH

Order designation		Dimensions									Inserts*
L	R	h	b	l	v	w	h _{max}	a			□ 77...

STANDARD-LINE

1600-3/8"x80 90 ST LA	■	1600-3/8"x80 90 ST RA	■	9.525	9.525	80	17	15	5	3	1611...
1600-3/8"x100 90 ST LA	■	1600-3/8"x100 90 ST RA	■	9.525	9.525	100	17	15	5	3	1611...
1600-1/2"x100 90 ST LA	■	1600-1/2"x100 90 ST RA	■	12.7	12.7	100	17	15	5	3	1611...
1600-5/8"x125 90 ST LA	■	1600-5/8"x125 90 ST RA	■	15.875	15.875	125	17	15.875	5	3	1611...
1600-3/4"x125 90 ST LA	■	1600-3/4"x125 90 ST RA	■	19.05	19.05	125	17	19.05	5	3	1611...

* Attention
 Right hand holder needs left hand insert!

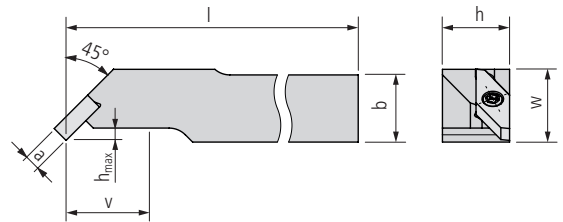
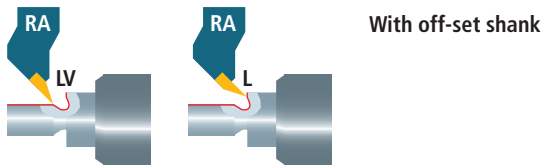

1600... 45 ST A

Order designation		Dimensions									Inserts
L	R	h	b	l	v	w	h _{max}	a			□ 64...

STANDARD-LINE

1600-08x100 45 ST LA	■	1600-08x100 45 ST RA	■	8	8	100	17	13	2	3		1604...SP 1611-45...
1600-10x80 45 ST LA	■	1600-10x80 45 ST RA	■	10	10	80	17	13	2	3		
1600-10x100 45 ST LA	■	1600-10x100 45 ST RA	■	10	10	100	17	13	2	3		
1600-12x100 45 ST LA	■	1600-12x100 45 ST RA	■	12	12	100	17	13	2	3		
1600-16x125 45 ST LA	■	1600-16x125 45 ST RA	■	16	16	125	17	16	2	3		

1600... 45 ST A INCH

Order designation		Dimensions									Inserts
L	R	h	b	l	v	w	h _{max}	a			□ 64...

STANDARD-LINE

1600-3/8"x80 45 ST LA	■	1600-3/8"x80 45 ST RA	■	9.525	9.525	80	17	13	2	3		1604...SP 1611-45...
1600-3/8"x100 45 ST LA	■	1600-3/8"x100 45 ST RA	■	9.525	9.525	100	17	13	2	3		
1600-1/2"x100 45 ST LA	■	1600-1/2"x100 45 ST RA	■	12.7	12.7	100	17	13	2	3		
1600-5/8"x125 45 ST LA	■	1600-5/8"x125 45 ST RA	■	15.875	15.875	125	17	15.875	2	3		



With these combinations of holder and insert, radially and axially undercuts, up to a limited depth, can be turned with standard inserts 1604... SP... Otherwise, we can grind special inserts, adapted to your needs.

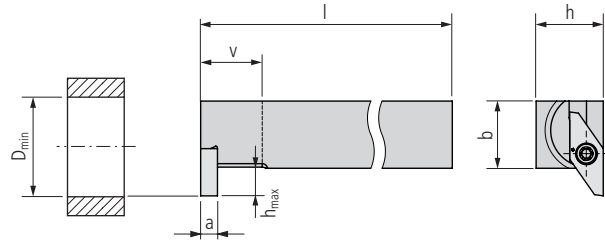
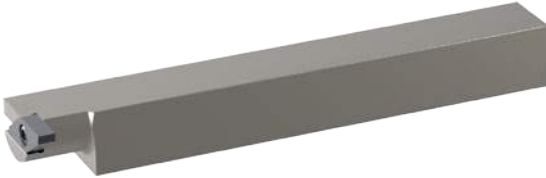

1600... 90 ST

Order designation		Dimensions									Inserts*
L	R	h	b	l	v	h _{max}	D _{min}	a		□51...	

STANDARD-LINE

1600-10x100 90 ST L	■	1600-10x100 90 ST R	■	10	10	100	11	5	21	3	16...
1600-12x100 90 ST L	■	1600-12x100 90 ST R	■	12	12	100	11	5	21	3	16...
1600-16x125 90 ST L	■	1600-16x125 90 ST R	■	16	16	125	11	5	21	3	16...

* Attention
 Right hand holder needs left hand insert!



For special inserts – multidec4you®

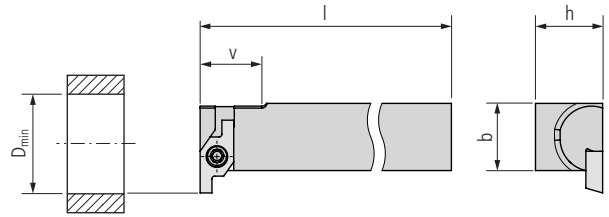
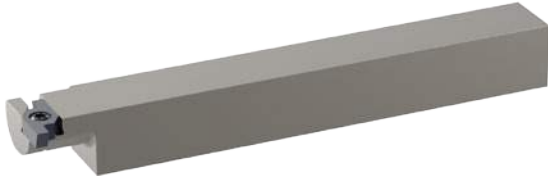

1600... 90

Order designation				Dimensions							Inserts*	
L		R		h	b	l	v	D _{min}				600...
STANDARD-LINE												
1600-10x100 90 L	■	1600-10x100 90 R	■	10	10	100	11	17				16...
1600-12x100 90 L	■	1600-12x100 90 R	■	12	12	100	11	17				16...

* Attention
 Right hand holder needs left hand insert!

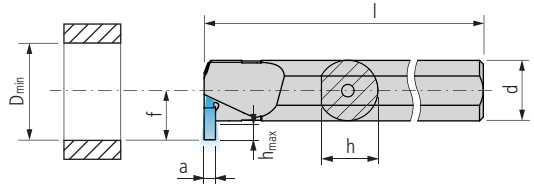
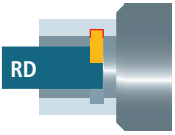

1600... 90 RD . IC

Order designation		Dimensions									Inserts*
L	R	d	l	h_{max}	D_{min}	a	f	h			□51...
		g6									

STANDARD-LINE

1600-12x125 90 RD L IC	■	1600-12x125 90 RD R IC	■	12	125	3	17	3	11	11	16...
1600-16x150 90 RD L IC	■	1600-16x150 90 RD R IC	■	16	150	3.5	21	3	13	15	16...
1600-20x180 90 RD L IC	■	1600-20x180 90 RD R IC	■	20	180	4	25	3	15	19	16...

* Attention
Right hand holder needs left hand insert!

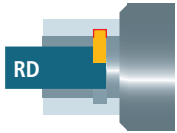

For 6 mm and 8 mm wide inserts

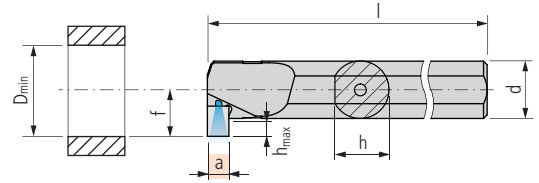

1600...-6-8 90 RD . IC

Order designation		Dimensions							Inserts*
L	R	d	l	h _{max}	D _{min}	a	f	h	□ 600...
		g6							
STANDARD-LINE									
1600-16x150-6-8 90 RD L IC	■	16	150	3.5	21	6	13	15	16...
1600-20x180-6-8 90 RD L IC	■	20	180	4	25	6	15	19	16...
1600-16x150-6-8 90 RD R IC	■	16	150	3.5	21	6	13	15	16...
1600-20x180-6-8 90 RD R IC	■	20	180	4	25	6	15	19	16...

* Attention
 Right hand holder needs left hand insert!

Replacement and spare parts

Illustration	Description	Dimensions	Order designation	Holder
	TORX screw	M2.5 × 6 T08	MSP 25060 T08	1600... 3*
		M2.5 × 7 T08	MSP 25070 T08	1600... 4*
		M2.5 × 9 T08	MSP 25090 T08	1600... 6* 1600... 8*

* Cutting edge width "a"

TORX screwdriver □ 651...

Legend □ 8...

The turning system 1700 ideally complements the existing system 1600. The inclined position of the insert in the holder enables the tool to pass close to complex shapes with no risk of collision. The inserts consist of two cutting edges. Even for the holders a wide range of possibilities with shank sizes between 8 and 20 mm are available. For Swiss-type automatic lathes special holders have been designed and complete the wide range of choices.

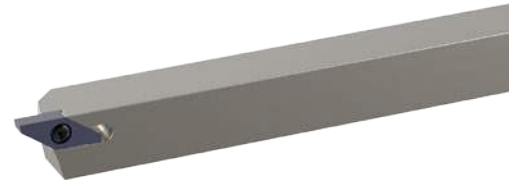

Advantages:

- Tool holder clearance given from insert seat
- Grooving inserts width starting from 0.05 mm
- "WCT" threading program for turning NIHS 60–30 threads in watch cases



2°

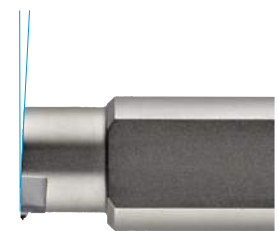

Overview – multidec®-CUT 1700

Technical information	11
-----------------------	----

Inserts



1701...	98
1706... WCT	99
1710...	100
1711...	101

HOLDERS

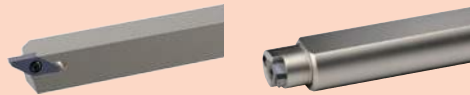

1700... WCT	103
1700...	104
1700... 92 ST	105
1700... 92 STA	106

Replacement and spare parts



107

Blank

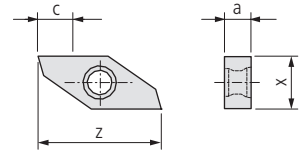
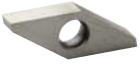

1701...

Order designation	Carbide						HSS		Dimensions				Holder
	□ 20	□ 20	□ 20	□ 20	□ 20	□ 20	□ 20	□ 20	a	c	x	z	□ 103...
N	-	-	●	○	●	●	●	●					
	○	●	●	○	●	●	○	○					
	○	○	-	○	○	-	-	-					
	-	-	●	-	-	○	-	-					
	UHM 10	UHM 10 HX	UHM 10 TX+	UHM 20	UHM 20 HPX	UHM 20 TX+	HSS	HSS HX					
PREMIUM-LINE													
1701-3-5 N P ...*			■	■	■				3	5	6	16	1700...
STANDARD-LINE													
1701-3-5 N ...			■	■	■	■	■		3	5	6	16	1700...

* Mirror polished

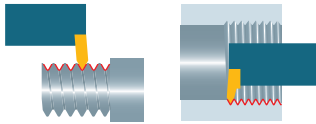

Threading (full profile metric) watch cases



1706... WCT

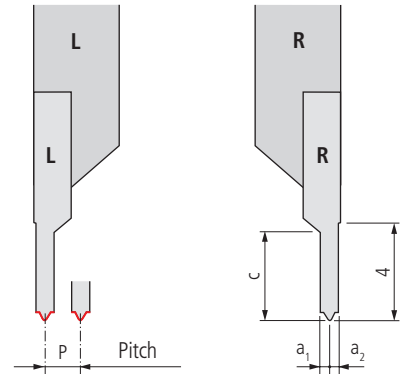
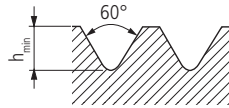

Order designation		Carbide						□ 20	Standard	Dimensions						Holder
		●	○	●	○	●	○									
		○	●	○	●	○	●									
		●	○	●	○	●	○									
		○	●	○	●	○	●									
L	R	UHM 10	UHM 10 HX	UHM 10 TX+	UHM 20	UHM 20 HPX	UHM 20 TX+		NIHS 60-30	P	h _{min}	a ₁	a ₂	b	c	□ 103...
PREMIUM-LINE																
1706-0.5-60 VP L WCT NIHS...		1706-0.5-60 VP R WCT NIHS...								0.5	0.315	0.35	0.28	2	1	1700... WCT

Recommendations for thread cutting □ 170

Legend □ 8...

100

UTILIS
multidec[®]
swiss type tools



Grooving (radial)



1710...

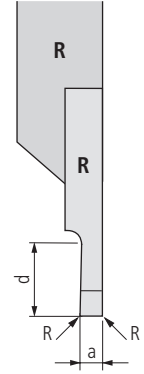
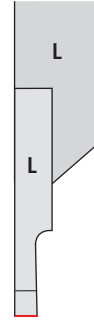

Order designation	Carbide						Dimensions					Holder
	-	-	●	○	●	●	a	R	d	β	s	□ 104...
L	UHM 10	UHM 10 HX	UHM 10 TX+	UHM 20	UHM 20 HPX	UHM 20 TX+						
R												

PREMIUM-LINE

1710-0.05-0.1 L ...	1710-0.05-0.1 R ...				■	■	■	0.05 ±0.01	-	0.1	6°	1.2	1700...
1710-0.1-0.2 L ...	1710-0.1-0.2 R ...				■	■	■	0.1 ±0.01	-	0.2	6°	1.2	1700...
1710-0.2-0.4 L ...	1710-0.2-0.4 R ...				■	■	■	0.2 ±0.01	-	0.4	6°	1.2	1700...

STANDARD-LINE

1710-0.3-0.6 L ...	1710-0.3-0.6 R ...				■	■	■	0.3 ±0.02	-	0.6	6°	1.2	1700...
1710-0.4-0.8 L ...	1710-0.4-0.8 R ...				■	■	■	0.4 ±0.02	-	0.8	6°	1.2	1700...
1710-0.5-1.0 L ...	1710-0.5-1.0 R ...				■	■	■	0.5 ±0.02	-	1	6°	1.2	1700...
1710-0.6-1.2 L ...	1710-0.6-1.2 R ...				■	■	■	0.6 ±0.02	-	1.2	6°	1.2	1700...
1710-0.7-1.4 L ...	1710-0.7-1.4 R ...				■	■	■	0.7 ±0.02	-	1.4	6°	1.2	1700...
1710-0.8-1.6 L ...	1710-0.8-1.6 R ...				■	■	■	0.8 ±0.02	-	1.6	6°	1.2	1700...
1710-1.0-2.0 L ...	1710-1.0-2.0 R ...				■	■	■	1 ±0.02	-	2	6°	1.2	1700...
1710-1.5-3.0 L ...	1710-1.5-3.0 R ...				■	■	■	1.5 ±0.02	-	3	6°	1.2	1700...
1710-2.0-4.0 L ...	1710-2.0-4.0 R ...				■	■	■	2 ±0.02	-	4	6°	1.2	1700...

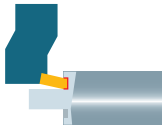

Grooving (axial)

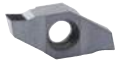

1711...

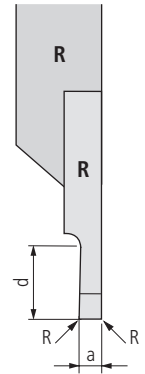
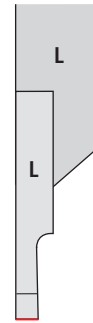
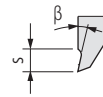

Order designation		Carbide						Dimensions						Holder
L	R	-	-	●	○	●	●	a	R	D _{min}	d	β	s	□ 104...
		○	●	●	○	○	●							
		●	○	-	●	○	-							
		-	-	●	-	○	-							
		UHM 10	UHM 10 HX	UHM 10 TX+	UHM 20	UHM 20 HPX	UHM 20 TX+							
		±0.02												

STANDARD-LINE

1711-0.5-1 L ...	1711-0.5-1 R ...				■	■	■	0.5	0.05	8	1	8°	1.2	1700...
1711-0.8-1.5 L ...	1711-0.8-1.5 R ...				■	■	■	0.8	0.05	8	1.5	8°	1.2	1700...
1711-1.0-2 L ...	1711-1.0-2 R ...				■	■	■	1	0.05	9	2	8°	1.2	1700...
1711-1.5-2.5 L ...	1711-1.5-2.5 R ...				■	■	■	1.5	0.05	14	2.5	8°	1.2	1700...
1711-2.0-3 L ...	1711-2.0-3 R ...				■	■	■	2	0.05	17	3	8°	1.2	1700...
1711-2.5-3.5 L ...	1711-2.5-3.5 R ...				■	■	■	2.5	0.05	18	3.5	8°	1.2	1700...

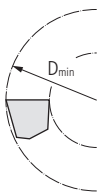

Attention
The groove must not be made underneath the D_{min}-position.

Pay attention to the "working situations" for the correct selection of the combinations of tools and inserts □ 26...

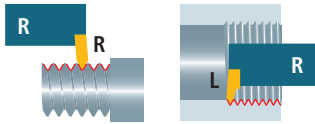

For external and internal turning

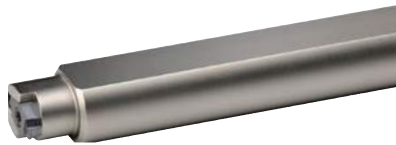

1700... WCT

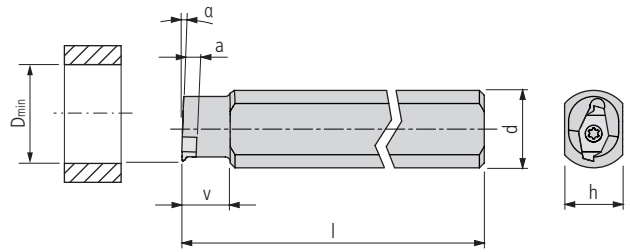

Order designation		Dimensions										Inserts*
L	R	d	l	h	v	D _{min}	a	α				99
		g6										
PREMIUM-LINE												
1700-12x100 WCT CS D16 L	■	1700-12x100 WCT CS D16 R	■	16	100	12	10	14	3	2°	1706... WCT...	

* Attention
 Right hand holder needs left hand insert!

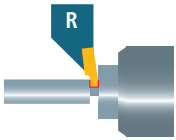

Standard

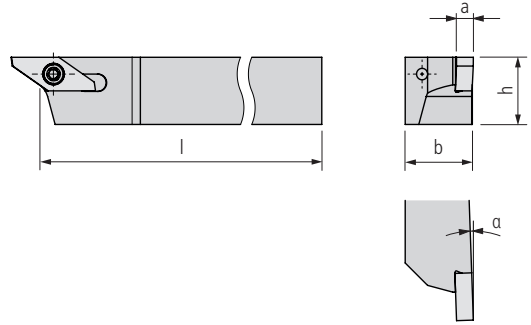
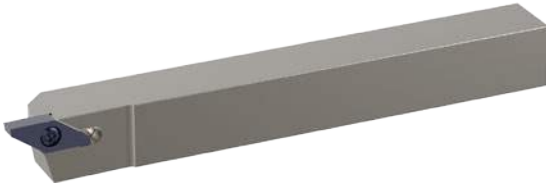

1700...

Order designation		Dimensions							Inserts*
L	R	h	b	l	a	α			□ 100

STANDARD-LINE

1700-08x80 L	■	1700-08x80 R	■	8	8	80	3	2°			17...
1700-08x100 L	■	1700-08x100 R	■	8	8	100	3	2°			17...
1700-10x80 L	■	1700-10x80 R	■	10	10	80	3	2°			17...
1700-10x100 L	■	1700-10x100 R	■	10	10	100	3	2°			17...
1700-12x100 L	■	1700-12x100 R	■	12	12	100	3	2°			17...
1700-16x125 L	■	1700-16x125 R	■	16	16	125	3	2°			17...
1700-20x125 L	■	1700-20x125 R	■	20	20	125	3	2°			17...

1700... INCH

Order designation		Dimensions							Inserts*
L	R	h	b	l	a	α			□ 100

STANDARD-LINE

1700-3/8"x80 L	■	1700-3/8"x80 R	■	9.525	9.525	80	3	2°			17...
1700-3/8"x100 L	■	1700-3/8"x100 R	■	9.525	9.525	100	3	2°			17...
1700-1/2"x100 L	■	1700-1/2"x100 R	■	12.7	12.7	100	3	2°			17...
1700-5/8"x125 L	■	1700-5/8"x125 R	■	15.875	15.875	125	3	2°			17...
1700-3/4"x125 L	■	1700-3/4"x125 R	■	19.05	19.05	125	3	2°			17...

* Attention
Right hand holder needs left hand insert!

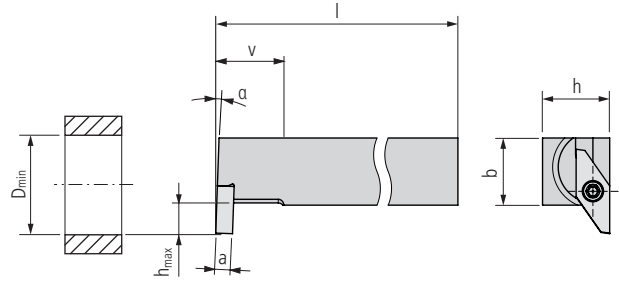

1700... 92 ST

Order designation		Dimensions										Inserts*
L	R	h	b	l	v	h _{max}	a	α	α	D _{min}	□ 100	

STANDARD-LINE

1700-08x100 92 ST L	■	1700-08x100 92 ST R	■	8	8	100	11	5	3	2°	21	17...
1700-10x100 92 ST L	■	1700-10x100 92 ST R	■	10	10	100	11	5	3	2°	21	17...
1700-12x100 92 ST L	■	1700-12x100 92 ST R	■	12	12	100	11	5	3	2°	21	17...
1700-16x125 92 ST L	■	1700-16x125 92 ST R	■	16	16	125	11	5	3	2°	21	17...
1700-20x125 92 ST L	■	1700-20x125 92 ST R	■	20	20	125	11	5	3	2°	21	17...

1700... 92 ST INCH

Order designation		Dimensions										Inserts*
L	R	h	b	l	v	h _{max}	a	α	α	D _{min}	□ 100	

STANDARD-LINE

1700-3/8"x100 92 ST L	■	1700-3/8"x100 92 ST R	■	9.525	9.525	100	11	5	3	2°	21	17...
1700-1/2"x100 92 ST L	■	1700-1/2"x100 92 ST R	■	12.7	12.7	100	11	5	3	2°	21	17...
1700-5/8"x125 92 ST L	■	1700-5/8"x125 92 ST R	■	15.875	15.875	125	11	5	3	2°	21	17...
1700-3/4"x125 92 ST L	■	1700-3/4"x125 92 ST R	■	19.05	19.05	125	11	5	3	2°	21	17...

* Attention
 Right hand holder needs left hand insert!

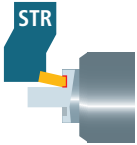

With off-set shank

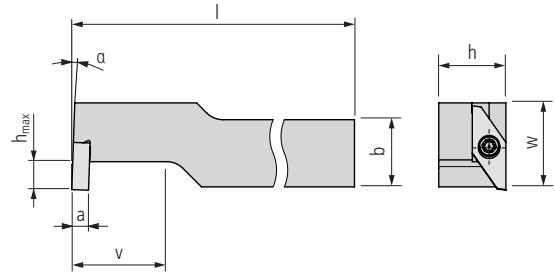

1700... 92 ST A

Order designation		Dimensions									Inserts*
L	R	h	b	l	v	w	h _{max}	a	α	□ 101	

STANDARD-LINE

1700-08x80 92 ST LA	■	1700-08x80 92 ST RA	■	8	8	80	17	15	5	3	2°	1711...
1700-08x100 92 ST LA	■	1700-08x100 92 ST RA	■	8	8	100	17	15	5	3	2°	1711...
1700-10x80 92 ST LA	■	1700-10x80 92 ST RA	■	10	10	80	17	15	5	3	2°	1711...
1700-10x100 92 ST LA	■	1700-10x100 92 ST RA	■	10	10	100	17	15	5	3	2°	1711...
1700-12x100 92 ST LA	■	1700-12x100 92 ST RA	■	12	12	100	17	15	5	3	2°	1711...
1700-16x125 92 ST LA	■	1700-16x125 92 ST RA	■	16	16	125	17	16	5	3	2°	1711...
1700-20x125 92 ST LA	■	1700-20x125 92 ST RA	■	20	20	125	17	20	5	3	2°	1711...

1700... 92 ST A INCH

Order designation		Dimensions									Inserts*
L	R	h	b	l	v	w	h _{max}	a	α	□ 101	

STANDARD-LINE

1700-3/8"x80 92 ST LA	■	1700-3/8"x80 92 ST RA	■	9.525	9.525	80	17	15	5	3	2°	1711...
1700-3/8"x100 92 ST LA	■	1700-3/8"x100 92 ST RA	■	9.525	9.525	100	17	15	5	3	2°	1711...
1700-1/2"x100 92 ST LA	■	1700-1/2"x100 92 ST RA	■	12.7	12.7	100	17	15	5	3	2°	1711...
1700-5/8"x125 92 ST LA	■	1700-5/8"x125 92 ST RA	■	15.875	15.875	125	17	15.875	5	3	2°	1711...
1700-3/4"x125 92 ST LA	■	1700-3/4"x125 92 ST RA	■	19.05	19.05	125	17	19.05	5	3	2°	1711...

* Attention
 Right hand holder needs left hand insert!

Illustration	Description	Dimensions	Order designation		Holder
	TORX screw	M2.5 × 6 T08	MSP 25060 T08	■	1700...

TORX screwdriver 651...

A turn and cut-off tool system for Swiss type lathes up to bar diameter 32 mm. The cutting inserts consist of two cutting edges. The insert seat, which is protected against contamination permits 100 % utilization of all cutting edges.

Even for the holders a wide range of possibilities with shank sizes between 8 and 25 mm are available. For Swiss-type automatic lathes special holders have been designed and complete the wide range of choices.

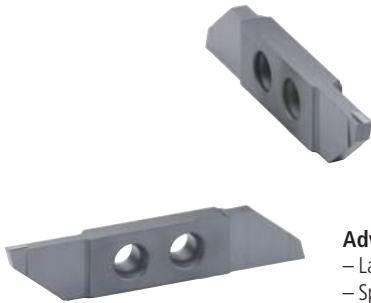

Advantages:

- Large selection of insert geometries with different chip breaker geometries
- Special chip breaker design for machining of small to mid-sized work pieces
- Perpendicularity guaranteed by two fixing screws, large support face and a genuine stop face for axial positioning
- The cutting forces are transferred directly from the insert to the holder
- 2nd edge still usable after the first has crashed



"IC" tool holder with integrated cooling

Cost-efficient processing of modern materials increasingly requires accurate control of the coolant at the cutting edge. Conveying the coolant as close as possible to the cutting edge is often a difficult task in the machine rooms of Swiss type turning lathes.

The multidec®-IC program offers a wide range of holders with integrated cooling. Because of the high precision and pressure, it is possible to discharge the chip quickly and safely from the cutting edge and the workpiece, which protects the cutting edge of the insert. This means significantly longer tool life as well as very reliable serial production.

Advantages:

- All holders feature five possible connectors for the coolant supply
- Fixed coolant exit allows for small set-up in front of the holder
- With or without high pressure, the coolant medium always hits the cutting edge precisely



"AK" holder with integrated coolant supply for machines with a revolving turret

The AK holder is ideally suitable for using the inserts of the multidec®-CUT 3000 system on lathes with a revolving turret. There are two fixed coolant outlets in the offset head section. A coolant connection with a G $\frac{1}{8}$ " thread is attached to the front on the outside. There are three other M5 connections on the top, bottom and side of the holder which can be used for supplying the coolant directly, provided that the turret is appropriately designed.

Advantages:

- Use of multidec®-CUT 3000 cutting edges on machines with a revolving turret
- Several connection/delivery options for the integrated cooling
- The coolant always lands on the cutting edge precisely, with or without high pressure



Lasered chip breaker "GS12"

Perfect chip control is an important factor in modern production nowadays. This can be achieved using the newly developed neutral cut-off insert "GS12", which is manufactured using state-of-the-art laser technology.

Advantages:

- Better chip control and therefore more process reliability.
- Wear-resistant and hard metal substrate with coating
- Sharp cutting edges
- Can be used on all holders of the multidec®-CUT 3000 series

Laser GS12

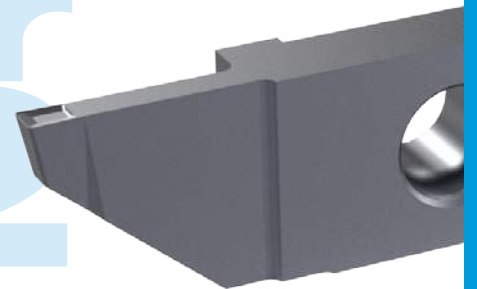

Chip breaker "GS"

This insert with the chip breaker "GS" was developed using a revolutionary new manufacturing technology. Geometry, carbide and coating are perfectly matched to cut off all materials.

Advantages:

- Optimally tuned carbide and coating for high cutting speeds
- Good chip control by special chip breaker
- Rounded cutting edge "E" for steel and easily machineable stainless steel
- Sharp cutting edge "F" for super-alloys, non-ferrous metals and stainless steels which are difficult to machine
- Can be used on all holders of the multidec®-CUT 3000 series



Inserts

3001...	113
3002..., 3002... V	114
3002... TOP, 3002... V TOP	116
3002... 16, 3002... 16 V	118
3002... SC, 3002... V SC	120
3002... SC TOP, 3002... V SC TOP	122
3002... N SC	124
3002... SPT, 3002... V SPT	126
3002... N SPT	128
3002... F.N GS12	129
3002... GS, 3002... V GS	130
3002... N GS	132
3003...	133
3003... SP ...TOP	134
3004... V SP	135
3004... SP	136
3004... TOP	137
3004... SP TOP	138
3004... CP, 3004... V CP	139
3005...	140
3005... CP	141
3006... VP	142
3006... VP-S	143
3006... UN ...VP	144
3006-G ...VP	145
3006...	146
3007...	147
3012...	148



Holder

3000...	150
3000... IC	151
3000... AV	152
3000... AV IC	153
3000... A	154
3000... A IC	155
3000... C (Combi)	156
Clamping of the insert on holder 3000... C (Combi)	157
3000 AK... IC	158

Replacement and spare parts



159



Coolant system and accessories

619



A series of horizontal lines for writing notes, consisting of 28 evenly spaced lines.

Blank

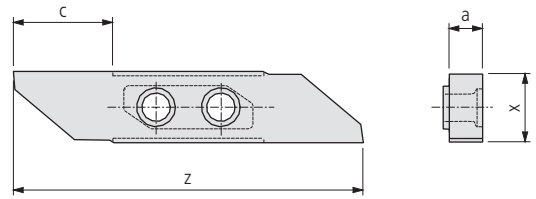

3001...

Order designation		Carbide						□ 20	HSS		Dimensions				Holder
		-	-	●	○	●	●	●	●	●					□ 150...
		○	●	●	○	○	●	○	○	○					
		●	○	-	●	○	○	-	-	○					
		-	-	●	-	○	○	-	-	-					
L	R	UHM 10	UHM 10 HX	UHM 10 TX+	UHM 20	UHM 20 HPX	UHM 20 TX+	HSS	HSS HX	a	c	x	z		

PREMIUM-LINE

3001-3.5-10 LP ...*	3001-3.5-10 RP ...*				■	■	■			3.5	11	8	40.5	3000...
3001-3.6-17 LP ...*	3001-3.6-17 RP ...*				■	■	■			3.6	17	8	51.5	3000...

STANDARD-LINE

3001-3.5-10 L ...	3001-3.5-10 R ...				■	■	■	■	■	3.5	11	8	40.5	3000...
3001-3.6-17 L ...	3001-3.6-17 R ...				■	■	■	■	■	3.6	17	8	51.5	3000...

* Mirror polished

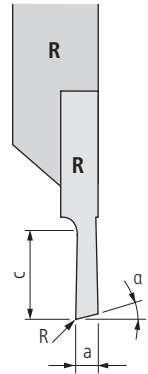
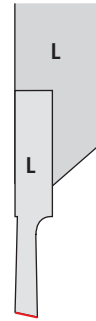
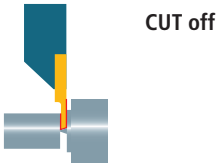

3002...

Order designation	Carbide						Dimensions				Holder
	-	-	●	○	●	●	a	c	α	R	□ 150...
L	UHM 10	UHM 10 HX	UHM 10 TX+	UHM 20	UHM 20 HPX	UHM 20 TX+					

STANDARD-LINE

3002-0.8-6 L ...	3002-0.8-6 R ...			■	■	■	0.8	6	15°	-			3000...
3002-0.8-10 L ...	3002-0.8-10 R ...			■	■	■	0.8	10	15°	-			3000...
3002-1.0-6 L ...	3002-1.0-6 R ...			■	■	■	1	6	15°	-			3000...
3002-1.0-13 L ...	3002-1.0-13 R ...			■	■	■	1	13	15°	-			3000...
3002-1.2-6 L ...	3002-1.2-6 R ...			■	■	■	1.2	6	15°	-			3000...
3002-1.5-8 L ...	3002-1.5-8 R ...			■	■	■	1.5	8	15°	-			3000...
3002-1.5-16 L ...	3002-1.5-16 R ...			■	■	■	1.5	16	15°	-			3000...
3002-1.8-8 L ...	3002-1.8-8 R ...			■	■	■	1.8	8	15°	-			3000...
3002-2.0-10 L ...	3002-2.0-10 R ...			■	■	■	2	10	15°	-			3000...
3002-2.0-16 L ...	3002-2.0-16 R ...			■	■	■	2	16	15°	-			3000...
3002-2.5-13 L ...	3002-2.5-13 R ...			■	■	■	2.5	13	15°	-			3000...
3002-2.5-16 L ...	3002-2.5-16 R ...			■	■	■	2.5	16	15°	-			3000...
3002-3.0-16 L ...	3002-3.0-16 R ...			■	■	■	3	16	15°	-			3000...

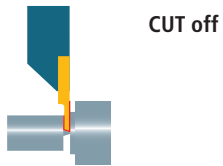

3002... V

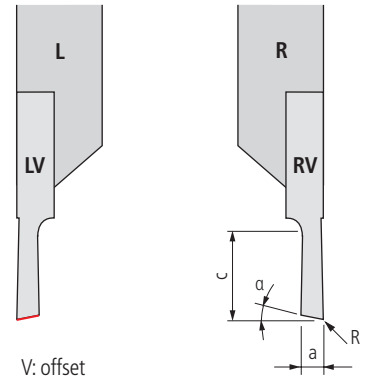

Order designation	Carbide						Dimensions				Holder
	-	-	●	○	●	●	a	c	α	R	□ 150...
L	UHM 10	UHM 10 HX	UHM 10 TX+	UHM 20	UHM 20 HPX	UHM 20 TX+					
R											

STANDARD-LINE

3002-0.8-6 LV ...	3002-0.8-6 RV ...			■	■	■	0.8	6	15°	-		3000...
3002-0.8-10 LV ...	3002-0.8-10 RV ...			■	■	■	0.8	10	15°	-		3000...
3002-1.0-6 LV ...	3002-1.0-6 RV ...			■	■	■	1	6	15°	-		3000...
3002-1.0-13 LV ...	3002-1.0-13 RV ...			■	■	■	1	13	15°	-		3000...
3002-1.2-6 LV ...	3002-1.2-6 RV ...			■	■	■	1.2	6	15°	-		3000...
3002-1.5-8 LV ...	3002-1.5-8 RV ...			■	■	■	1.5	8	15°	-		3000...
3002-1.5-16 LV ...	3002-1.5-16 RV ...			■	■	■	1.5	16	15°	-		3000...
3002-1.8-8 LV ...	3002-1.8-8 RV ...			■	■	■	1.8	8	15°	-		3000...
3002-2.0-10 LV ...	3002-2.0-10 RV ...			■	■	■	2	10	15°	-		3000...
3002-2.0-16 LV ...	3002-2.0-16 RV ...			■	■	■	2	16	15°	-		3000...
3002-2.5-13 LV ...	3002-2.5-13 RV ...			■	■	■	2.5	13	15°	-		3000...
3002-2.5-16 LV ...	3002-2.5-16 RV ...			■	■	■	2.5	16	15°	-		3000...
3002-3.0-16 LV ...	3002-3.0-16 RV ...			■	■	■	3	16	15°	-		3000...

Turning and cut off



3002... TOP*

Detail TOP*

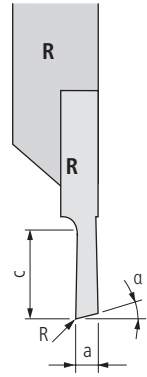
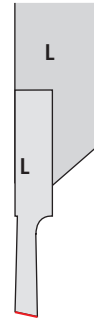
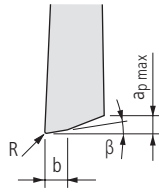

Order designation		Carbide □ 20						Dimensions							Holder □ 150...
-	-	●	○	●	●	●	a	c	α	R	β	b	ap max	3002...	
-	○	●	○	○	●	●									
○	●	●	○	○	○	●									
●	○	-	●	○	-	○									
-	-	●	-	-	-	○									
-	-	○	-	-	-	-									
L	R	UHM 10	UHM 10 HX	UHM 10 TX+	UHM 20	UHM 20 HPX	UHM 20 TX+								

STANDARD-LINE

3002-2.0-10 L TOP 015 ...	3002-2.0-10 R TOP 015 ...				■	■	■	2	10	15°	0.15	1.5°	0.3	0.45	3000...
---------------------------	---------------------------	--	--	--	---	---	---	---	----	-----	------	------	-----	------	---------

* Description TOP □ 13



Turning and cut off



3002... V TOP*

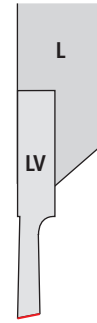
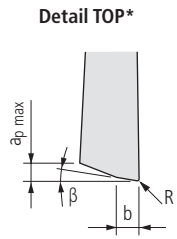

V: offset

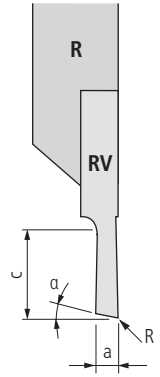

Order designation	Carbide						Dimensions							Holder
	UHM 10	UHM 10 HX	UHM 10 TX+	UHM 20	UHM 20 HPX	UHM 20 TX+	a	c	α	R	β	b	ap max	150...
L	-	-	●	○	●	●								
R	○	●	●	○	●	●								
	●	○	-	●	○	-								
	-	-	●	-	○	-								

STANDARD-LINE

3002-2.0-10 LV TOP 015 ...	3002-2.0-10 RV TOP 015 ...			■	■	■	2	10	15°	0.15	1.5°	0.3	0.45	3000...
----------------------------	----------------------------	--	--	---	---	---	---	----	-----	------	------	-----	------	---------

* Description TOP 13

CUT off with counter-spindle

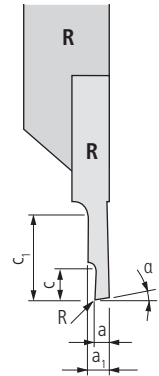
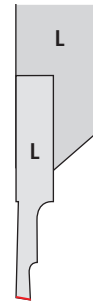

3002...16

Order designation		Carbide						Dimensions						Holder
		-	-	●	○	●	●							□ 150...
		○	●	●	○	○	○							
		●	○	-	●	-	-							
		-	-	●	-	-	○							
L	R	UHM 10	UHM 10 HX	UHM 10 TX+	UHM 20	UHM 20 HPX	UHM 20 TX+	a	a ₁	c	c ₁	α	R	

PREMIUM-LINE

3002-0.5-2.5-16 L G20 ...	3002-0.5-2.5-16 R G20 ...							0.5	1.9	2.5	16	20°	-	3000...
---------------------------	---------------------------	--	--	--	--	--	--	-----	-----	-----	----	-----	---	---------

STANDARD-LINE

3002-0.8-6-16 L ...	3002-0.8-6-16 R ...				■	■	■	0.8	2	6	16	15°	-	3000...
3002-1.0-6-16 L ...	3002-1.0-6-16 R ...				■	■	■	1	2.2	6	16	15°	-	3000...
3002-1.2-6-16 L ...	3002-1.2-6-16 R ...				■	■	■	1.2	2.4	6	16	15°	-	3000...



CUT off with counter-spindle

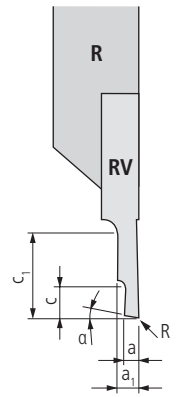
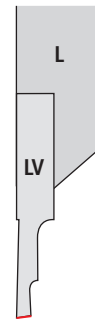

V: offset

3002...16 V

Order designation		Carbide						Dimensions						Holder
L	R	-	-	●	○	●	●	a	a ₁	c	c ₁	α	R	□ 150...
		○	●	●	○	○	○							
		●	○	-	●	○	-							
		-	-	●	-	○	○							
		UHM 10	UHM 10 HX	UHM 10 TX+	UHM 20	UHM 20 HPX	UHM 20 TX+							
PREMIUM-LINE														
3002-0.5-2.5-16 LV G20 ...	3002-0.5-2.5-16 RV G20 ...			■	■	■	0.5	1.9	2.5	16	20°	-	3000...	
STANDARD-LINE														
3002-0.8-6-16 LV ...	3002-0.8-6-16 RV ...				■	■	0.8	2	6	16	15°	-	3000...	
3002-1.0-6-16 LV ...	3002-1.0-6-16 RV ...				■	■	1	2.2	6	16	15°	-	3000...	
3002-1.2-6-16 LV ...	3002-1.2-6-16 RV ...				■	■	1.2	2.4	6	16	15°	-	3000...	

120

UTILIS
multidec[®]
swiss type tools



CUT off

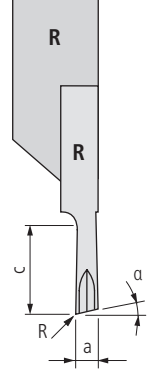
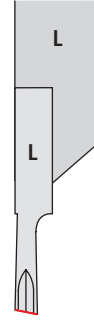

3002... SC

Order designation	Carbide						Dimensions				Holder
	-	-	●	○	●	●	a	c	α	R	□ 150...
L	UHM 10	UHM 10 HX	UHM 10 TX+	UHM 20	UHM 20 HPX	UHM 20 TX+					
R											

STANDARD-LINE

3002-1.5-8 L SC ...	3002-1.5-8 R SC ...			■	■	■	1.5	8	15°	-		3000...
3002-1.5-16 L SC ...	3002-1.5-16 R SC ...			■	■	■	1.5	16	15°	-		3000...
3002-2.0-10 L SC ...	3002-2.0-10 R SC ...			■	■	■	2	10	15°	-		3000...
3002-2.0-16 L SC ...	3002-2.0-16 R SC ...			■	■	■	2	16	15°	-		3000...
3002-2.5-13 L SC ...	3002-2.5-13 R SC ...			■	■	■	2.5	13	15°	-		3000...
3002-2.5-16 L SC ...	3002-2.5-16 R SC ...			■	■	■	2.5	16	15°	-		3000...
3002-3.0-16 L SC ...	3002-3.0-16 R SC ...			■	■	■	3	16	15°	-		3000...

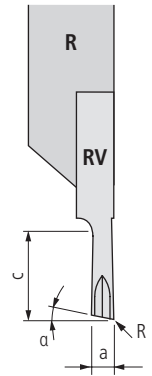
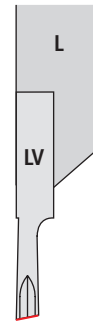
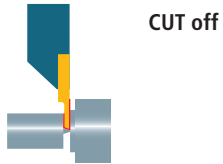

V: offset

3002... V SC

Order designation	Carbide						Dimensions				Holder
	-	-	●	○	●	●	a	c	α	R	□ 150...
L	UHM 10	UHM 10 HX	UHM 10 TX+	UHM 20	UHM 20 HPX	UHM 20 TX+					
R											

STANDARD-LINE

3002-1.5-8 LV SC ...	3002-1.5-8 RV SC ...			■	■	■	1.5	8	15°	-		3000...
3002-1.5-16 LV SC ...	3002-1.5-16 RV SC ...			■	■	■	1.5	16	15°	-		3000...
3002-2.0-10 LV SC ...	3002-2.0-10 RV SC ...			■	■	■	2	10	15°	-		3000...
3002-2.0-16 LV SC ...	3002-2.0-16 RV SC ...			■	■	■	2	16	15°	-		3000...
3002-2.5-13 LV SC ...	3002-2.5-13 RV SC ...			■	■	■	2.5	13	15°	-		3000...
3002-2.5-16 LV SC ...	3002-2.5-16 RV SC ...			■	■	■	2.5	16	15°	-		3000...
3002-3.0-16 LV SC ...	3002-3.0-16 RV SC ...			■	■	■	3	16	15°	-		3000...

Turning and cut off



Detail TOP*

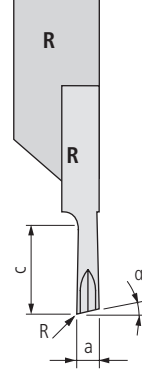
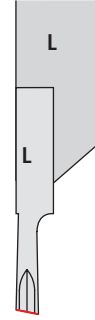
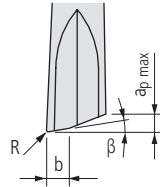

3002... SCTOP*

Order designation		Carbide □ 20						Dimensions							Holder □ 150...
-	-	●	○	●	●	●	a	c	α	R	β	b	ap max	3000...	
-	●	●	○	●	●	●									
○	●	●	○	○	●	●									
●	○	-	●	○	-	○									
-	-	●	-	-	-	○									
-	-	●	-	-	-	○									
L	R	UHM 10	UHM 10 HX	UHM 10 TX+	UHM 20	UHM 20 HPX	UHM 20 TX+								

STANDARD-LINE

3002-2.0-10 L SCTOP 015 ...	3002-2.0-10 R SC TOP 015 ...			■	■	■	2	10	15°	0.15	1.5°	0.3	0.45	3000...
-----------------------------	------------------------------	--	--	---	---	---	---	----	-----	------	------	-----	------	---------

* Description TOP □ 13



Turning and cut off



3002... V SC TOP*

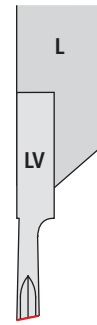
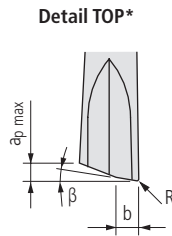

V: offset

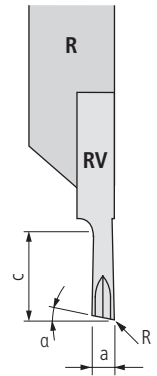

Order designation		Carbide						Dimensions						Holder	
		□ 20												□ 150...	
		-	-	●	○	●	●								
		-	●	●	○	●	●								
		○	●	●	○	○	●								
		●	○	-	●	○	-								
		-	-	●	-	○	○								
L	R	UHM 10	UHM 10 HX	UHM 10 TX+	UHM 20	UHM 20 HPX	UHM 20 TX+	a	c	α	R	β	b	ap max	
STANDARD-LINE															
3002-2.0-10 LV SC TOP 015 ...		3002-2.0-10 RV SC TOP 015 ...		■	■	■		2	10	15°	0.15	1.5°	0.3	0.45	3000...

* Description TOP □ 13

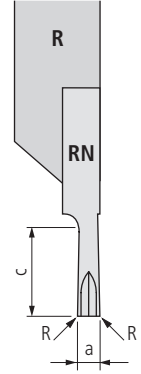
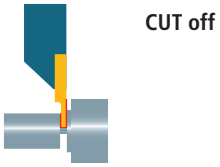

N: neutral

3002... N SC

Order designation	Carbide						Dimensions						Holder
	-	-	●	○	●	●	a	c	R				□ 150...
L	UHM 10	UHM 10 HX	UHM 10 TX+	UHM 20	UHM 20 HPX	UHM 20 TX+							
R													

STANDARD-LINE

3002-1.5-10 LN SC ...	3002-1.5-10 RN SC ...				■	■	■	1.5	10	0.08				3000...
3002-1.5-16 LN SC ...	3002-1.5-16 RN SC ...				■	■	■	1.5	16	0.08				3000...
3002-2.0-10 LN SC ...	3002-2.0-10 RN SC ...				■	■	■	2	10	0.08				3000...
3002-2.0-16 LN SC ...	3002-2.0-16 RN SC ...				■	■	■	2	16	0.08				3000...
3002-2.5-13 LN SC ...	3002-2.5-13 RN SC ...				■	■	■	2.5	13	0.08				3000...
3002-2.5-16 LN SC ...	3002-2.5-16 RN SC ...				■	■	■	2.5	16	0.08				3000...
3002-3.0-16 LN SC ...	3002-3.0-16 RN SC ...				■	■	■	3	16	0.08				3000...

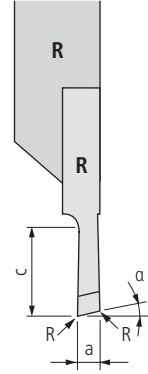
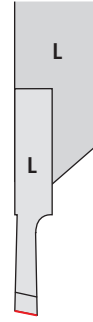
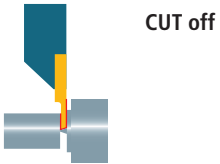

3002... SPT

Order designation	Carbide						Dimensions						Holder □ 150...
	□ 10	□ 12	□ 15	□ 20	□ 25	□ 30	a	c	α	β	R	s	
L	-	-	●	○	●	●							
	○	●	●	○	○	○							
	●	○	-	●	○	-							
	-	-	●	-	○	○							
	UHM 10	UHM 10 HX	UHM 10 TX+	UHM 20	UHM 20 HPX	UHM 20 TX+							

STANDARD-LINE

3002-0.8-10 L SPT ...	3002-0.8-10 R SPT ...				■	■	■	0.8	10	15°	20°	-	2	3000...
3002-1.0-13 L SPT ...	3002-1.0-13 R SPT ...				■	■	■	1	13	15°	20°	-	2	3000...
3002-1.5-8 L SPT ...	3002-1.5-8 R SPT ...				■	■	■	1.5	8	15°	20°	-	2	3000...
3002-1.5-8 L SPT06 ...	3002-1.5-8 R SPT06 ...				■	■	■	1.5	8	15°	6°	0.05	2	3000...
3002-1.5-8 L SPT12 ...	3002-1.5-8 R SPT12 ...				■	■	■	1.5	8	15°	12°	0.05	2	3000...
3002-1.5-16 L SPT ...	3002-1.5-16 R SPT ...				■	■	■	1.5	16	15°	20°	-	2	3000...
3002-2.0-10 L SPT ...	3002-2.0-10 R SPT ...				■	■	■	2	10	15°	20°	-	2	3000...
3002-2.0-10 L SPT06 ...	3002-2.0-10 R SPT06 ...				■	■	■	2	10	15°	6°	0.05	2	3000...
3002-2.0-10 L SPT12 ...	3002-2.0-10 R SPT12 ...				■	■	■	2	10	15°	12°	0.05	2	3000...
3002-2.0-16 L SPT ...	3002-2.0-16 R SPT ...				■	■	■	2	16	15°	20°	-	2	3000...
3002-2.0-16 L SPT06 ...	3002-2.0-16 R SPT06 ...				■	■	■	2	16	15°	6°	0.05	2	3000...
3002-2.0-16 L SPT12 ...	3002-2.0-16 R SPT12 ...				■	■	■	2	16	15°	12°	0.05	2	3000...
3002-2.5-13 L SPT ...	3002-2.5-13 R SPT ...				■	■	■	2.5	13	15°	20°	-	2	3000...
3002-2.5-13 L SPT06 ...	3002-2.5-13 R SPT06 ...				■	■	■	2.5	13	15°	6°	0.05	2	3000...
3002-2.5-13 L SPT12 ...	3002-2.5-13 R SPT12 ...				■	■	■	2.5	13	15°	12°	0.05	2	3000...
3002-2.5-16 L SPT ...	3002-2.5-16 R SPT ...				■	■	■	2.5	16	15°	20°	-	2	3000...
3002-2.5-16 L SPT06 ...	3002-2.5-16 R SPT06 ...				■	■	■	2.5	16	15°	6°	0.05	2	3000...
3002-2.5-16 L SPT12 ...	3002-2.5-16 R SPT12 ...				■	■	■	2.5	16	15°	12°	0.05	2	3000...
3002-3.0-16 L SPT ...	3002-3.0-16 R SPT ...				■	■	■	3	16	15°	20°	-	2	3000...
3002-3.0-16 L SPT06 ...	3002-3.0-16 R SPT06 ...				■	■	■	3	16	15°	6°	0.05	2	3000...
3002-3.0-16 L SPT12 ...	3002-3.0-16 R SPT12 ...				■	■	■	3	16	15°	12°	0.05	2	3000...

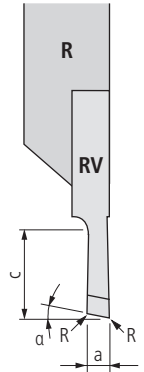
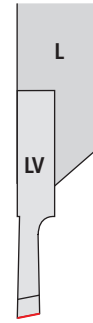
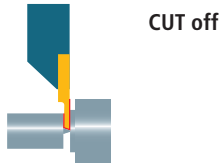

V: offset

3002... V SPT

Order designation	Carbide						Dimensions						Holder
	-	-	●	○	●	●	a	c	α	β	R	s	□ 150...
L	UHM 10	UHM 10 HX	UHM 10 TX+	UHM 20	UHM 20 HPX	UHM 20 TX+							
R													

STANDARD-LINE

3002-0.8-10 LV SPT ...	3002-0.8-10 RV SPT ...				■	■	■	0.8	10	15°	20°	-	2	3000...
3002-1.0-13 LV SPT ...	3002-1.0-13 RV SPT ...				■	■	■	1	13	15°	20°	-	2	3000...
3002-1.5-8 LV SPT ...	3002-1.5-8 RV SPT ...				■	■	■	1.5	8	15°	20°	-	2	3000...
3002-1.5-8 LV SPT06 ...	3002-1.5-8 RV SPT06 ...				■	■	■	1.5	8	15°	6°	0.05	2	3000...
3002-1.5-8 LV SPT12 ...	3002-1.5-8 RV SPT12 ...				■	■	■	1.5	8	15°	12°	0.05	2	3000...
3002-1.5-16 LV SPT ...	3002-1.5-16 RV SPT ...				■	■	■	1.5	16	15°	20°	-	2	3000...
3002-2.0-10 LV SPT ...	3002-2.0-10 RV SPT ...				■	■	■	2	10	15°	20°	-	2	3000...
3002-2.0-10 LV SPT06 ...	3002-2.0-10 RV SPT06 ...				■	■	■	2	10	15°	6°	0.05	2	3000...
3002-2.0-10 LV SPT12 ...	3002-2.0-10 RV SPT12 ...				■	■	■	2	10	15°	12°	0.05	2	3000...
3002-2.0-16 LV SPT ...	3002-2.0-16 RV SPT ...				■	■	■	2	16	15°	20°	-	2	3000...
3002-2.0-16 LV SPT06 ...	3002-2.0-16 RV SPT06 ...				■	■	■	2	16	15°	6°	0.05	2	3000...
3002-2.0-16 LV SPT12 ...	3002-2.0-16 RV SPT12 ...				■	■	■	2	16	15°	12°	0.05	2	3000...
3002-2.5-13 LV SPT ...	3002-2.5-13 RV SPT ...				■	■	■	2.5	13	15°	20°	-	2	3000...
3002-2.5-13 LV SPT06 ...	3002-2.5-13 RV SPT06 ...				■	■	■	2.5	13	15°	6°	0.05	2	3000...
3002-2.5-13 LV SPT12 ...	3002-2.5-13 RV SPT12 ...				■	■	■	2.5	13	15°	12°	0.05	2	3000...
3002-2.5-16 LV SPT ...	3002-2.5-16 RV SPT ...				■	■	■	2.5	16	15°	20°	-	2	3000...
3002-2.5-16 LV SPT06 ...	3002-2.5-16 RV SPT06 ...				■	■	■	2.5	16	15°	6°	0.05	2	3000...
3002-2.5-16 LV SPT12 ...	3002-2.5-16 RV SPT12 ...				■	■	■	2.5	16	15°	12°	0.05	2	3000...
3002-3.0-16 LV SPT ...	3002-3.0-16 RV SPT ...				■	■	■	3	16	15°	20°	-	2	3000...
3002-3.0-16 LV SPT06 ...	3002-3.0-16 RV SPT06 ...				■	■	■	3	16	15°	6°	0.05	2	3000...
3002-3.0-16 LV SPT12 ...	3002-3.0-16 RV SPT12 ...				■	■	■	3	16	15°	12°	0.05	2	3000...

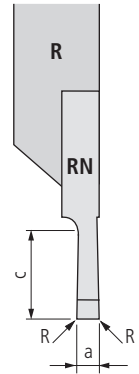
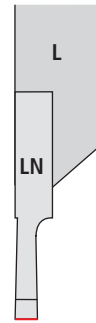
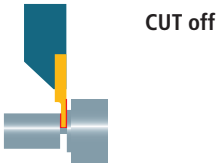

N: neutral

3002... N SPT

Order designation	Carbide						Dimensions					Holder
	-	-	●	○	●	●	a	c	R	s	β	□ 150...
L	UHM 10	UHM 10 HX	UHM 10 TX+	UHM 20	UHM 20 HPX	UHM 20 TX+						
R												

STANDARD-LINE

Order designation	Order designation															
3002-1.0-10 LN SPT ...	3002-1.0-10 RN SPT ...				■	■	■	1	10	0.05	2	20°				3000...
3002-1.5-10 LN SPT ...	3002-1.5-10 RN SPT ...				■	■	■	1.5	10	0.05	2	20°				3000...
3002-1.5-10 LN SPT06 ...	3002-1.5-10 RN SPT06 ...				■	■	■	1.5	10	0.05	2	6°				3000...
3002-1.5-10 LN SPT12 ...	3002-1.5-10 RN SPT12 ...				■	■	■	1.5	10	0.05	2	12°				3000...
3002-1.5-16 LN SPT ...	3002-1.5-16 RN SPT ...				■	■	■	1.5	16	0.05	2	20°				3000...
3002-2.0-10 LN SPT ...	3002-2.0-10 RN SPT ...				■	■	■	2	10	0.05	2	20°				3000...
3002-2.0-10 LN SPT06 ...	3002-2.0-10 RN SPT06 ...				■	■	■	2	10	0.05	2	6°				3000...
3002-2.0-10 LN SPT12 ...	3002-2.0-10 RN SPT12 ...				■	■	■	2	10	0.05	2	12°				3000...
3002-2.0-16 LN SPT ...	3002-2.0-16 RN SPT ...				■	■	■	2	16	0.05	2	20°				3000...
3002-2.0-16 LN SPT06 ...	3002-2.0-16 RN SPT06 ...				■	■	■	2	16	0.05	2	6°				3000...
3002-2.0-16 LN SPT12 ...	3002-2.0-16 RN SPT12 ...				■	■	■	2	16	0.05	2	12°				3000...
3002-2.5-13 LN SPT ...	3002-2.5-13 RN SPT ...				■	■	■	2.5	13	0.05	2	20°				3000...
3002-2.5-13 LN SPT06 ...	3002-2.5-13 RN SPT06 ...				■	■	■	2.5	13	0.05	2	6°				3000...
3002-2.5-13 LN SPT12 ...	3002-2.5-13 RN SPT12 ...				■	■	■	2.5	13	0.05	2	12°				3000...
3002-2.5-16 LN SPT ...	3002-2.5-16 RN SPT ...				■	■	■	2.5	16	0.05	2	20°				3000...
3002-2.5-16 LN SPT06 ...	3002-2.5-16 RN SPT06 ...				■	■	■	2.5	16	0.05	2	6°				3000...
3002-2.5-16 LN SPT12 ...	3002-2.5-16 RN SPT12 ...				■	■	■	2.5	16	0.05	2	12°				3000...
3002-3.0-16 LN SPT ...	3002-3.0-16 RN SPT ...				■	■	■	3	16	0.05	2	20°				3000...
3002-3.0-16 LN SPT06 ...	3002-3.0-16 RN SPT06 ...				■	■	■	3	16	0.05	2	6°				3000...
3002-3.0-16 LN SPT12 ...	3002-3.0-16 RN SPT12 ...				■	■	■	3	16	0.05	2	12°				3000...



Cut-off with lasered chip breaker



F: Insert with sharp cutting edge

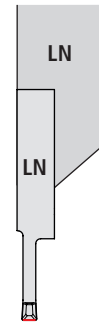

N: neutral

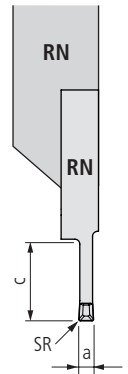

3002... F.N GS12

Order designation	Carbide						Dimensions			Holder
	UHM 10	UHM 10 HX	UHM 10 TX+	UHM 20	UHM 20 HPX	UHM 20 TX+	a	c	SR*	150...
L	-	-	●	○	●	●				
R	○	●	●	○	●	●				
	●	○	-	●	○	-				
	-	-	●	-	-	○				

PREMIUM-LINE

3002-1.5-10 FLN GS12 ...	3002-1.5-10 FRN GS12 ...				■	■	1.5	10	0.15			3000...
3002-1.5-16 FLN GS12 ...	3002-1.5-16 FRN GS12 ...				■	■	1.5	16	0.15			3000...
3002-2.0-10 FLN GS12 ...	3002-2.0-10 FRN GS12 ...				■	■	2	10	0.2			3000...
3002-2.0-16 FLN GS12 ...	3002-2.0-16 FRN GS12 ...				■	■	2	16	0.2			3000...
3002-2.5-13 FLN GS12 ...	3002-2.5-13 FRN GS12 ...				■	■	2.5	13	0.2			3000...
3002-2.5-16 FLN GS12 ...	3002-2.5-16 FRN GS12 ...				■	■	2.5	16	0.2			3000...
3002-3.0-16 FLN GS12 ...	3002-3.0-16 FRN GS12 ...				■	■	3	16	0.2			3000...

* SR: Protection radius

130

UTILIS
multidec
swiss type tools



CUT off

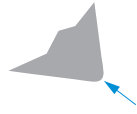

E: Insert with rounded cutting edge



F: Insert with sharp cutting edge

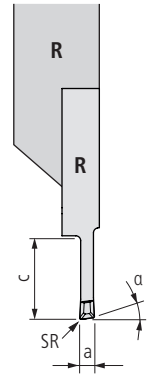
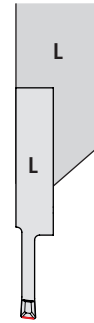

3002... E. GS

Order designation		Carbide						Dimensions				Holder	
		□ 20										□ 150...	
-	-	●	○	●	●		a	c	α	SR*			
-	-	●	○	○	○	●							
○	●	●	○	○	○	○							
●	○	-	-	○	○	-							
-	-	-	-	-	-	○							
L	R	UHM 10	UHM 10 HX	UHM 10 TX+	UHM 20	UHM 20 HPX							
VALUE-LINE													
3002-2.0-10 EL GS ...		3002-2.0-10 ER GS ...		■	■	■	2	10	15°	0.2			3000...

* SR: Protection radius

3002... F. GS

Order designation		Carbide						Dimensions				Holder	
		□ 20										□ 150...	
-	-	●	○	●	●		a	c	α	R			
-	-	●	○	○	○	●							
○	●	●	○	○	○	○							
●	○	-	-	○	○	-							
-	-	-	-	-	-	○							
L	R	UHM 10	UHM 10 HX	UHM 10 TX+	UHM 20	UHM 20 HPX							
VALUE-LINE													
3002-2.0-10 FL GS ...		3002-2.0-10 FR GS ...		■	■	■	2	10	15°	0.2			3000...

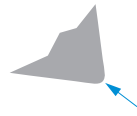

E: Insert with rounded cutting edge



F: Insert with sharp cutting edge

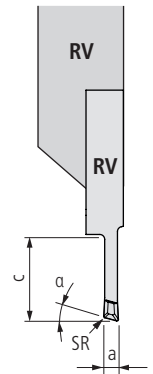
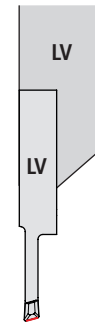

V: offset

3002... E.V GS

Order designation		Carbide						Dimensions				Holder		
		□ 20										□ 150...		
-	-	●	○	●	●	●	a	c	α	SR*				
-	-	●	○	○	○	○								
○	○	●	○	○	○	○								
●	○	-	●	-	○	-								
-	-	-	-	-	-	○								
-	-	-	-	-	-	○								
L	R	UHM 10	UHM 10 HX	UHM 10 TX+	UHM 20	UHM 20 HPX	UHM 20 TX+							
VALUE-LINE														
3002-2.0-10 ELV GS ...		3002-2.0-10 ERV GS ...		■	■	■	2	10	15°	0.2				3000...

* SR: Protection radius

3002... F.V GS

Order designation		Carbide						Dimensions				Holder		
		□ 20										□ 150...		
-	-	●	○	●	●	●	a	c	α	R				
-	-	●	○	○	○	○								
○	○	●	○	○	○	○								
●	○	-	●	-	○	-								
-	-	-	-	-	-	○								
-	-	-	-	-	-	○								
L	R	UHM 10	UHM 10 HX	UHM 10 TX+	UHM 20	UHM 20 HPX	UHM 20 TX+							
VALUE-LINE														
3002-2.0-10 FLV GS ...		3002-2.0-10 FRV GS ...		■	■	■	2	10	15°	0.2				3000...

Cutting off

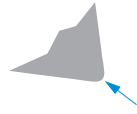

E: Insert with rounded cutting edge



F: Insert with sharp cutting edge

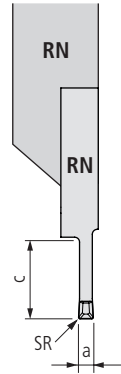
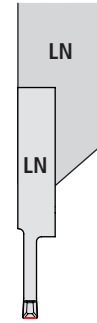

N: neutral

3002... E.N GS

Order designation		Carbide						Dimensions				Holder			
		□ 20										□ 150...			
-	-	●	○	●	●		a	c	α	SR*					
-	-	●	○	○	○	●									
○	●	●	○	○	○	○									
●	○	-	●	-	○	-									
-	-	-	-	-	-	○									
-	-	-	-	-	-	-									
L	R	UHM 10	UHM 10 HX	UHM 10 TX+	UHM 20	UHM 20 HPX	UHM 20 TX+								
VALUE-LINE															
3002-2.0-10 ELN GS ...		3002-2.0-10 ERN GS ...		■	■	■	2	10	-	0.2				3000...	

* SR: Protection radius

3002... F.N GS

Order designation		Carbide						Dimensions				Holder			
		□ 20										□ 150...			
-	-	●	○	●	●		a	c	α	R					
-	-	●	○	○	○	●									
○	●	●	○	○	○	○									
●	○	-	●	-	○	-									
-	-	-	-	-	-	○									
-	-	-	-	-	-	-									
L	R	UHM 10	UHM 10 HX	UHM 10 TX+	UHM 20	UHM 20 HPX	UHM 20 TX+								
VALUE-LINE															
3002-2.0-10 FLN GS ...		3002-2.0-10 FRN GS ...		■	■	■	2	10	-	0.2				3000...	



Front turning

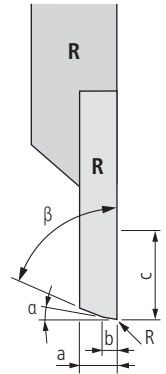
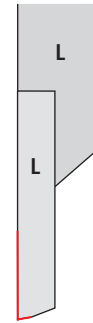

3003...

Order designation		Carbide						Dimensions						Holder
L	R	-	-	●	○	●	●	a	b	c	α	β	R	150...
		○	●	●	○	●	●							
		●	○	-	●	○	-							
		-	-	●	-	-	○							
		UHM 10	UHM 10 HX	UHM 10 TX+	UHM 20	UHM 20 HPX	UHM 20 TX+							
STANDARD-LINE														
3003-3.4-8 L...	3003-3.4-8 R...				■	■	■	3.4	1	8	3°	70°	-	3000...

Front turning

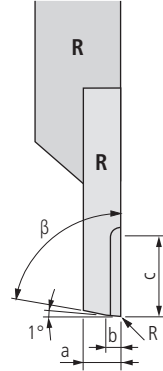
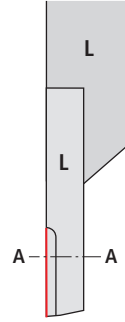
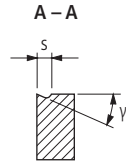

3003... SP ...TOP*

Order designation		Carbide						Dimensions							Holder
		-	-	●	○	●	●	a	b	c	β	s	γ	R	□ 150...
		-	●	●	○	●	●								
		○	●	●	○	●	●								
		●	○	-	●	○	-								
		-	-	●	-	-	○								
		-	-	●	-	-	○								
L	R	UHM 10	UHM 10 HX	UHM 10 TX+	UHM 20	UHM 20 HPX	UHM 20 TX+								

STANDARD-LINE

3003-3.4-8 L SP U TOP ZZ ...	3003-3.4-8 R SP U TOP ZZ ...				■	■	■	3.4	0.2	8	82°	1.2	12°	-	3000...
3003-3.4-8 L SP U TOP 45008 ...	3003-3.4-8 R SP U TOP 45008 ...				■	■	■	3.4	1.2	8	45°	1.2	12°	0.08	3000...
3003-3.4-8 L SP U TOP 45015 ...	3003-3.4-8 R SP U TOP 45015 ...				■	■	■	3.4	1.2	8	45°	1.2	12°	0.15	3000...

* Description TOP □ 13

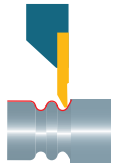

Copy turning (front)



3004... V SP

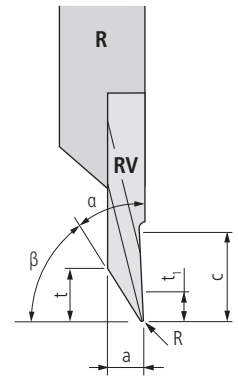
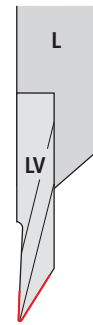

V: offset

Order designation	Carbide						Dimensions							Holder
	-	-	●	○	●	●	a	c	α	β	R	t	t_1	□ 150...
L	UHM 10	UHM 10 HX	UHM 10 TX+	UHM 20	UHM 20 HPX	UHM 20 TX+								
R														

STANDARD-LINE

3004-3.2-6 LV SP29008 ...	3004-3.2-6 RV SP29008 ...				■	■	■	3.2	11	29°	61°	0.08	5	2.5	3000...
3004-3.2-6 LV SP29015 ...	3004-3.2-6 RV SP29015 ...				■	■	■	3.2	11	29°	61°	0.15	5	2.5	3000...
3004-3.2-6 LV SP29035 ...	3004-3.2-6 RV SP29035 ...				■	■	■	3.2	11	29°	61°	0.35	5	2.5	3000...
3004-3.2-6 LV SP29075 ...	3004-3.2-6 RV SP29075 ...				■	■	■	3.2	11	29°	61°	0.75	5	2.5	3000...

Copy turning (back)

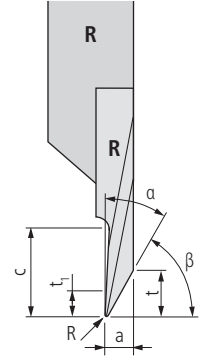
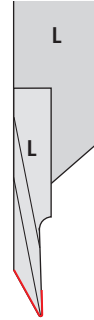

3004... SP

Order designation	Carbide						Dimensions							Holder
	-	-	●	○	●	●	a	c	α	β	R	t	t_1	□ 150...
L	UHM 10	UHM 10 HX	UHM 10 TX+	UHM 20	UHM 20 HPX	UHM 20 TX+								
R														

STANDARD-LINE

3004-3.2-6 L SP29008 ...	3004-3.2-6 R SP29008 ...				■	■	■	3.2	11	29°	61°	0.08	5	2.5	3000...
3004-3.2-6 L SP29015 ...	3004-3.2-6 R SP29015 ...				■	■	■	3.2	11	29°	61°	0.15	5	2.5	3000...
3004-3.2-6 L SP29035 ...	3004-3.2-6 R SP29035 ...				■	■	■	3.2	11	29°	61°	0.35	5	2.5	3000...
3004-3.2-6 L SP29075 ...	3004-3.2-6 R SP29075 ...				■	■	■	3.2	11	29°	61°	0.75	5	2.5	3000...
3004-3.2-5 L SP35015 ...	3004-3.2-5 R SP35015 ...				■	■	□	3.2	11	35°	55°	0.15	4	2	3000...
3004-3.2-5 L SP35035 ...	3004-3.2-5 R SP35035 ...				■	■	□	3.2	11	35°	55°	0.35	4	2	3000...



Back turning

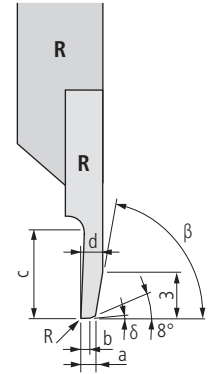
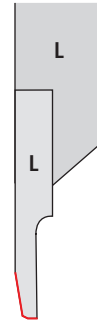

3004... TOP*

Order designation	Carbide						Dimensions								Holder
	-	-	●	○	●	●	a	b	c	d	β	R	δ	□ 150...	
L	UHM 10	UHM 10 HX	UHM 10 TX+	UHM 20	UHM 20 HPX	UHM 20 TX+									
R	-	○	-	-	○	○									

STANDARD-LINE

3004-0.8-6 L TOP ZZ ...	3004-0.8-6 R TOP ZZ ...				■	■	■	0.8	0.5	6	2	70°	-	1°	3000...
3004-1.0-6 L TOP ZZ ...	3004-1.0-6 R TOP ZZ ...				■	■	■	1	0.5	6	2.2	70°	-	1°	3000...
3004-1.2-8 L TOP ZZ ...	3004-1.2-8 R TOP ZZ ...				■	■	■	1.2	0.5	8	2.4	70°	-	1°	3000...
3004-1.5-8 L TOP ZZ ...	3004-1.5-8 R TOP ZZ ...				■	■	■	1.5	0.5	8	2.7	70°	-	1°	3000...
3004-1.8-8 L TOP ZZ ...	3004-1.8-8 R TOP ZZ ...				■	■	■	1.8	0.5	8	3	70°	-	1°	3000...

* Description TOP □ 13

Back turning

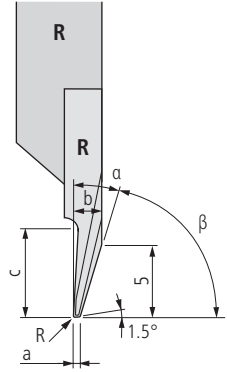
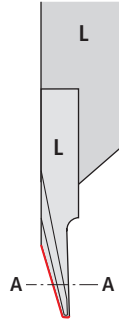
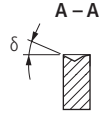

3004... SP TOP*

Order designation	Carbide						Dimensions							Holder
	-	-	●	○	●	●	a	c	b	α	β	δ	R	□ 150...
L	-	-	●	○	●	●								
R	○	●	●	○	○	●								
	●	○	-	●	○	-								
	-	-	●	-	-	○								
	UHM 10	UHM 10 HX	UHM 10 TX+	UHM 20	UHM 20 HPX	UHM 20 TX+								

STANDARD-LINE

3004-2.4-6 L SP TOP 20ZZ ...	3004-2.4-6 R SP TOP 20ZZ ...			■	■	■	0.5	6	2.4	20°	70°	15°	-	3000...
3004-2.4-6 L SP TOP 20008 ...	3004-2.4-6 R SP TOP 20008 ...			■	■	■	0.5	6	2.4	20°	70°	15°	0.08	3000...
3004-2.4-6 L SP TOP 20015 ...	3004-2.4-6 R SP TOP 20015 ...			■	■	■	0.5	6	2.4	20°	70°	15°	0.15	3000...

* Description TOP □ 13



Back turning

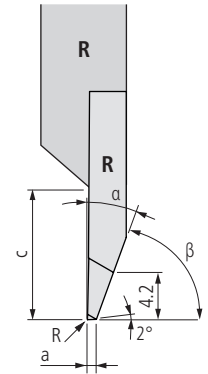
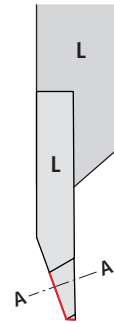
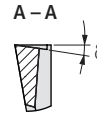

3004... CP

Order designation		Carbide						Dimensions					Holder	
L	R	-	-	●	○	●	●	a	c	α	β	R	δ	150...
		-	●	●	○	●	●							
		○	●	●	○	●	●							
		●	○	-	●	○	-							
		-	-	●	-	-	○							
		UHM 10	UHM 10 HX	UHM 10 TX+	UHM 20	UHM 20 HPX	UHM 20 TX+							
3004-0.8-4 L CP ...				■	■	■	0.8	11	20°	70°	-	8°	3000...	

STANDARD-LINE

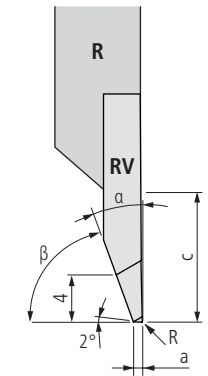
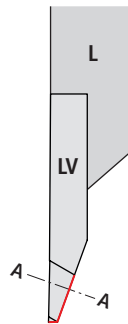

V: offset

3004... V CP

Order designation		Carbide						Dimensions					Holder	
L	R	-	-	●	○	●	●	a	c	α	β	R	δ	150...
		-	●	●	○	●	●							
		○	●	●	○	●	●							
		●	○	-	●	○	-							
		-	-	●	-	-	○							
		UHM 10	UHM 10 HX	UHM 10 TX+	UHM 20	UHM 20 HPX	UHM 20 TX+							
3004-0.8-4 LV CP ...				■	■	■	0.8	11	20°	70°	-	8°	3000...	

STANDARD-LINE



Grooving and turning

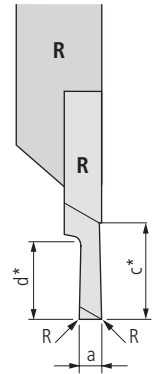
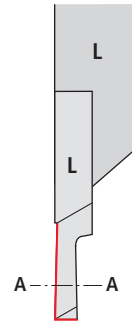
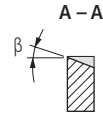

3005... CP

Order designation	Carbide						Dimensions					Holder
	-	-	●	○	●	●	a	c*	d*	R	β	□ 150...
L	UHM 10	UHM 10 HX	UHM 10 TX+	UHM 20	UHM 20 HPX	UHM 20 TX+						
R												

STANDARD-LINE

3005-0.8-8 L CP ...	3005-0.8-8 R CP ...			■	■	■	0.8	8	2.5	-	10°	3000...
3005-1.0-8 L CP ...	3005-1.0-8 R CP ...			■	■	■	1	8	3.5	-	10°	3000...
3005-1.5-8 L CP ...	3005-1.5-8 R CP ...			■	■	■	1.5	8	4	-	10°	3000...
3005-1.5-8 L CP R08 ...	3005-1.5-8 R CP R08 ...			■	■	■	1.5	8	4	0.08	10°	3000...
3005-2.0-8 L CP ...	3005-2.0-8 R CP ...			■	■	■	2	8	5	-	10°	3000...
3005-2.0-8 L CP R08 ...	3005-2.0-8 R CP R08 ...			■	■	■	2	8	5	0.08	10°	3000...
3005-2.0-8 L CP R15 ...	3005-2.0-8 R CP R15 ...			■	■	■	2	8	5	0.15	10°	3000...
3005-2.5-8 L CP ...	3005-2.5-8 R CP ...			■	■	■	2.5	8	6	-	10°	3000...
3005-2.5-8 L CP R08 ...	3005-2.5-8 R CP R08 ...			■	■	■	2.5	8	6	0.08	10°	3000...
3005-2.5-8 L CP R15 ...	3005-2.5-8 R CP R15 ...			■	■	■	2.5	8	6	0.15	10°	3000...
3005-3.0-8 L CP ...	3005-3.0-8 R CP ...			■	■	■	3	8	6	-	10°	3000...
3005-3.0-8 L CP R08 ...	3005-3.0-8 R CP R08 ...			■	■	■	3	8	6	0.08	10°	3000...
3005-3.0-8 L CP R15 ...	3005-3.0-8 R CP R15 ...			■	■	■	3	8	6	0.15	10°	3000...

* c: maximal turning capacity
d: maximal grooving capacity

Threading (full profile metric)

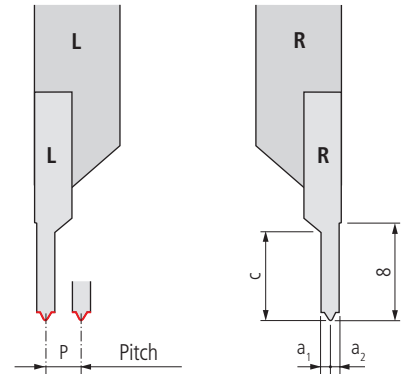
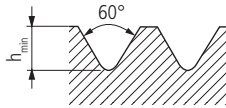
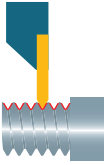

3006... VP

Order designation		Carbide						Standard			Dimensions					Holder
		-	-	●	○	●	●	ISO DIN13	NIHS 06-03	NIHS 06-02	P	h _{min}	a ₁	a ₂	c	□ 150...
L	R	UHM 10	UHM 10 HX	UHM 10 TX+	UHM 20	UHM 20 HPX	UHM 20 TX+									

PREMIUM-LINE

3006-0.15-10-60 VP L ...	3006-0.15-10-60 VP R ...				■	■	■	-	-	S 0.6	0.15	0.092	0.09	0.08	-	3000...
3006-0.175-10-60 VP L ...	3006-0.175-10-60 VP R ...				■	■	■	-	-	S 0.7	0.175	0.107	0.11	0.1	-	3000...
3006-0.2-10-60 VP L ...	3006-0.2-10-60 VP R ...				■	■	■	-	-	S 0.8	0.2	0.123	0.12	0.11	-	3000...
3006-0.225-10-60 VP L ...	3006-0.225-10-60 VP R ...				■	■	■	-	-	S 0.9	0.225	0.138	0.14	0.12	-	3000...
3006-0.25-10-60 VP L ...	3006-0.25-10-60 VP R ...				■	■	■	M 1/1.2	M 1/1.2	S 1/S1.2	0.25	0.153	0.15	0.14	-	3000...
3006-0.3-10-60 VP L ...	3006-0.3-10-60 VP R ...				■	■	■	-	M 1.4	S 1.4	0.3	0.184	0.18	0.17	-	3000...
3006-0.35-10-60 VP L ...	3006-0.35-10-60 VP R ...				■	■	■	M 1.6	M 1.6/1.8	-	0.35	0.215	0.21	0.19	-	3000...
3006-0.4-10-60 VP L ...	3006-0.4-10-60 VP R ...				■	■	■	M 2	M 2	-	0.4	0.245	0.24	0.22	-	3000...
3006-0.45-10-60 VP L ...	3006-0.45-10-60 VP R ...				■	■	■	M 2.5	M 2.2/2.5	-	0.45	0.276	0.27	0.25	-	3000...

STANDARD-LINE

3006-0.5-10-60 VP L ...	3006-0.5-10-60 VP R ...				■	■	■	M 3	M 3	-	0.5	0.307	0.28	0.28	1.3	3000...
3006-0.6-10-60 VP L ...	3006-0.6-10-60 VP R ...				■	■	■	-	M 3.5	-	0.6	0.368	0.33	0.33	1.5	3000...
3006-0.7-10-60 VP L ...	3006-0.7-10-60 VP R ...				■	■	■	M 4	M 4	-	0.7	0.429	0.39	0.39	1.8	3000...
3006-0.75-10-60 VP L ...	3006-0.75-10-60 VP R ...				■	■	■	-	M 4.5	-	0.75	0.46	0.41	0.41	1.9	3000...
3006-0.8-10-60 VP L ...	3006-0.8-10-60 VP R ...				■	■	■	M 5	M 5	-	0.8	0.491	0.44	0.44	2	3000...
3006-1.0-10-60 VP L ...	3006-1.0-10-60 VP R ...				■	■	■	M 6/7	-	-	1	0.613	0.55	0.55	2.5	3000...
3006-1.25-10-60 VP L ...	3006-1.25-10-60 VP R ...				■	■	■	M 8/9	-	-	1.25	0.767	0.69	0.69	3.1	3000...
3006-1.5-10-60 VP L ...	3006-1.5-10-60 VP R ...				■	■	■	M 10/11	-	-	1.5	0.92	0.83	0.83	3.8	3000...
3006-1.75-10-60 VP L ...	3006-1.75-10-60 VP R ...				■	■	■	M 12	-	-	1.75	1.073	0.96	0.96	4.4	3000...
3006-2.0-10-60 VP L ...	3006-2.0-10-60 VP R ...				■	■	■	M 14/16	-	-	2	1.227	1.1	1.1	5	3000...
3006-2.5-10-60 VP L ...	3006-2.5-10-60 VP R ...				■	■	■	M 18/20/22	-	-	2.5	1.534	1.4	1.4	5	3000...
3006-3.0-10-60 VP L ...	3006-3.0-10-60 VP R ...				■	■	■	M 24/27	-	-	3	1.84	1.65	1.65	5	3000...

Recommendations for thread cutting □ 170

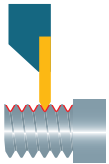

Threading (full profile metric)
Strengthen type "-S"

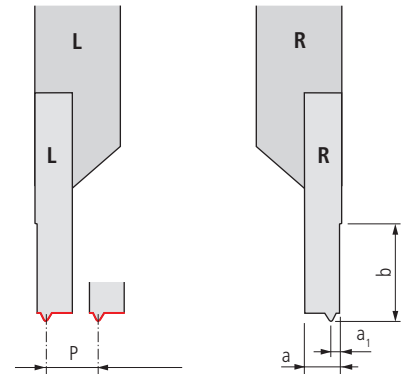
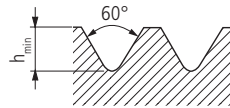

3006... VP-S

Order designation		Carbide						Standard			Dimensions				Holder
L	R	UHM 10	UHM 10 HX	UHM 10 TX+	UHM 20	UHM 20 HPX	UHM 20 TX+	ISO DIN13	NIHS 06-03	NIHS 06-02	P	h _{min}	a ₁	a	□ 150...
-	-	●	○	○	○	○	○								
○	○	●	●	●	●	●	●								
●	○	-	-	-	-	-	-								
-	-	●	○	○	○	○	○								

VALUE-LINE

3006-0.25-60 VP-S L ...	3006-0.25-60 VP-S R ...			■	■	■	M 1/1.2	M 1/1.2	S1/S1.2	0.25	0.153	0.16	3.4	3000...
3006-0.3-60 VP-S L ...	3006-0.3-60 VP-S R ...			■	■	■	-	M1.4	S1.4	0.3	0.184	0.2	3.4	3000...
3006-0.35-60 VP-S L ...	3006-0.35-60 VP-S R ...			■	■	■	M1.6	M1.6/1.8	-	0.35	0.215	0.23	3.4	3000...
3006-0.4-60 VP-S L ...	3006-0.4-60 VP-S R ...			■	■	■	M2	M2	-	0.4	0.245	0.26	3.4	3000...
3006-0.45-60 VP-S L ...	3006-0.45-60 VP-S R ...			■	■	■	M2.5	M2.2/2.5	-	0.45	0.276	0.29	3.4	3000...
3006-0.5-60 VP-S L ...	3006-0.5-60 VP-S R ...			■	■	■	M3	M3	-	0.5	0.307	0.33	3.4	3000...
3006-0.6-60 VP-S L ...	3006-0.6-60 VP-S R ...			■	■	■	-	M3.5	-	0.6	0.368	0.39	3.4	3000...
3006-0.7-60 VP-S L ...	3006-0.7-60 VP-S R ...			■	■	■	M4	M4	-	0.7	0.429	0.46	3.4	3000...
3006-0.75-60 VP-S L ...	3006-0.75-60 VP-S R ...			■	■	■	-	M4.5	-	0.75	0.46	0.49	3.4	3000...
3006-0.8-60 VP-S L ...	3006-0.8-60 VP-S R ...			■	■	■	M5	M5	-	0.8	0.491	0.52	3.4	3000...
3006-1.0-60 VP-S L ...	3006-1.0-60 VP-S R ...			■	■	■	M6/7	-	-	1	0.613	0.65	3.4	3000...
3006-1.25-60 VP-S L ...	3006-1.25-60 VP-S R ...			■	■	■	M8/9	-	-	1.25	0.767	0.81	3.4	3000...
3006-1.5-60 VP-S L ...	3006-1.5-60 VP-S R ...			■	■	■	M10/11	-	-	1.5	0.92	0.98	3.4	3000...
3006-1.75-60 VP-S L ...	3006-1.75-60 VP-S R ...			■	■	■	M12	-	-	1.75	1.073	1.14	3.4	3000...
3006-2.0-60 VP-S L ...	3006-2.0-60 VP-S R ...			■	■	■	M14/16	-	-	2	1.227	1.3	3.4	3000...

Recommendations for thread cutting □ 170

Threading (full profile UN)

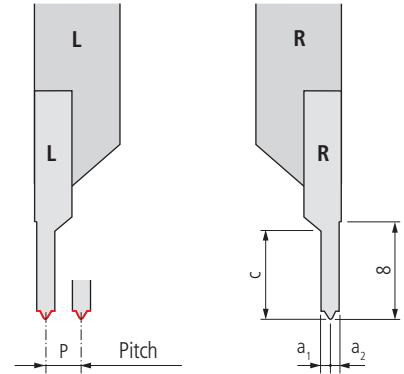
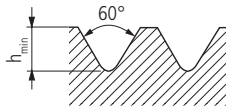
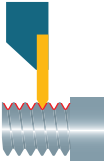

3006... UN ... VP

Order designation	Carbide						Standard / thread type	Dimensions					Holder
	UHM 10	UHM 10 HX	UHM 10 TX+	UHM 20	UHM 20 HPX	UHM 20 TX+		P (T/Inch)	P	h _{min}	a ₁	a ₂	
L	-	-	●	○	●	●	ANSI/ASME B1.1 (Tolerance class 2A/2B/3A/3B)						
R	○	●	●	○	●	●	UN						
	●	○	-	●	○	-	UNC						
	-	●	●	-	○	○	UNF						
							UNEF						
							UNS						
							UNR						

Accuracy class of UTILIS

PREMIUM-LINE

3006-80 UN 10-60 VP L ...	3006-80 UN 10-60 VP R ...				■	■	■	●		80	0.317	0.194	0.19	0.17	-	3000...
3006-72 UN 10-60 VP L ...	3006-72 UN 10-60 VP R ...				■	■	■	●		72	0.353	0.217	0.21	0.19	-	3000...
3006-64 UN 10-60 VP L ...	3006-64 UN 10-60 VP R ...				■	■	■	●	●	64	0.397	0.244	0.24	0.22	-	3000...
3006-56 UN 10-60 VP L ...	3006-56 UN 10-60 VP R ...				■	■	■	●	●	56	0.453	0.278	0.27	0.25	-	3000...

Accuracy class of UTILIS

STANDARD-LINE

3006-48 UN 10-60 VP L ...	3006-48 UN 10-60 VP R ...				■	■	■	●	●	48	0.529	0.325	0.29	0.29	1.4	3000...
3006-44 UN 10-60 VP L ...	3006-44 UN 10-60 VP R ...				■	■	■	●		44	0.577	0.354	0.32	0.32	1.4	3000...
3006-40 UN 10-60 VP L ...	3006-40 UN 10-60 VP R ...				■	■	■	●	●	40	0.635	0.39	0.35	0.35	1.8	3000...
3006-36 UN 10-60 VP L ...	3006-36 UN 10-60 VP R ...				■	■	■	●	●	36	0.705	0.432	0.39	0.39	1.8	3000...
3006-32 UN 10-60 VP L ...	3006-32 UN 10-60 VP R ...				■	■	■	●	●	32	0.794	0.487	0.44	0.44	2	3000...
3006-28 UN 10-60 VP L ...	3006-28 UN 10-60 VP R ...				■	■	■	●	●	28	0.907	0.556	0.5	0.5	2.2	3000...
3006-24 UN 10-60 VP L ...	3006-24 UN 10-60 VP R ...				■	■	■	●	●	24	1.058	0.649	0.58	0.58	2.4	3000...
3006-20 UN 10-60 VP L ...	3006-20 UN 10-60 VP R ...				■	■	■	●	●	20	1.27	0.779	0.7	0.7	2.9	3000...
3006-18 UN 10-60 VP L ...	3006-18 UN 10-60 VP R ...				■	■	■	●	●	18	1.411	0.866	0.78	0.78	3.4	3000...
3006-16 UN 10-60 VP L ...	3006-16 UN 10-60 VP R ...				■	■	■	●	●	16	1.588	0.974	0.87	0.87	3.6	3000...
3006-14 UN 10-60 VP L ...	3006-14 UN 10-60 VP R ...				■	■	■	●	●	14	1.814	1.113	1	1	3.9	3000...
3006-13 UN 10-60 VP L ...	3006-13 UN 10-60 VP R ...				■	■	■	●		13	1.954	1.199	1.07	1.07	4.2	3000...

Recommendations for thread cutting 170

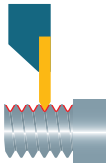

Threading (full profile pipe thread)

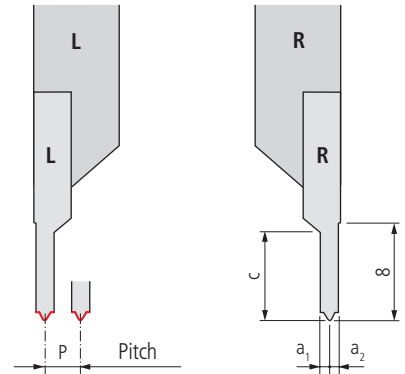
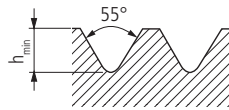

3006-G ...VP

Order designation		Carbide						□ 20	Standard	Dimensions						Holder
L	R	UHM 10	UHM 10 HX	UHM 10 TX+	UHM 20	UHM 20 HPX	UHM 20 TX+	ANSI B.1.1	P (T/Inch)	P	h _{min}	a ₁	a ₂	c	□ 150...	
		-	-	●	●	●	●									
		○	●	●	○	○	○									
		●	○	-	●	○	-									
		-	-	●	-	-	○									

Accuracy class of UTILIS

STANDARD-LINE

Order designation	Order designation	Carbide	Carbide	Carbide	Carbide	Carbide	Carbide	Standard	P (T/Inch)	P	h _{min}	a ₁	a ₂	c	Holder
3006-G 28 10-55 VP L ...	3006-G 28 10-55 VP R ...			■	■	■		1/8	28	0.907	0.581	0.5	0.5	2.3	3000...
								1/16	28	0.907	0.581	0.5	0.5	2.3	3000...
3006-G 19 10-55 VP L ...	3006-G 19 10-55 VP R ...			■	■	■		1/4	19	1.337	0.856	0.74	0.74	3.3	3000...
								3/8	19	1.337	0.856	0.74	0.74	3.3	3000...
3006-G 14 10-55 VP L ...	3006-G 14 10-55 VP R ...			■	■	■		1/2	14	1.814	1.162	1	1	4.5	3000...
								3/8	14	1.814	1.162	1	1	4.5	3000...
								1/4	14	1.814	1.162	1	1	4.5	3000...
								3/8	14	1.814	1.162	1	1	4.5	3000...
3006-G11 10-55 VP L ...	3006-G11 10-55 VP R ...			■	■	■		1	11	2.309	1.479	1.27	1.27	5	3000...
								1/8	11	2.309	1.479	1.27	1.27	5	3000...
								1/4	11	2.309	1.479	1.27	1.27	5	3000...
								1/2	11	2.309	1.479	1.27	1.27	5	3000...
								3/4	11	2.309	1.479	1.27	1.27	5	3000...
								1	11	2.309	1.479	1.27	1.27	5	3000...
								1 1/4	11	2.309	1.479	1.27	1.27	5	3000...
								1 1/2	11	2.309	1.479	1.27	1.27	5	3000...
								2	11	2.309	1.479	1.27	1.27	5	3000...
								2 1/4	11	2.309	1.479	1.27	1.27	5	3000...
								2 1/2	11	2.309	1.479	1.27	1.27	5	3000...
								2 3/4	11	2.309	1.479	1.27	1.27	5	3000...
								3	11	2.309	1.479	1.27	1.27	5	3000...
								3 1/2	11	2.309	1.479	1.27	1.27	5	3000...
								4	11	2.309	1.479	1.27	1.27	5	3000...
								4 1/2	11	2.309	1.479	1.27	1.27	5	3000...
								5	11	2.309	1.479	1.27	1.27	5	3000...
								5 1/2	11	2.309	1.479	1.27	1.27	5	3000...
								6	11	2.309	1.479	1.27	1.27	5	3000...

Recommendations for thread cutting □ 170

Legend □ 8...

Threading (partial profile 60°/55°)

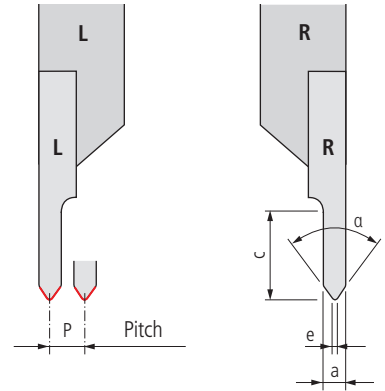
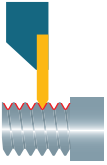

3006...

Order designation	Carbide						Dimensions					Holder
	-	-	●	○	●	●	P	a	c	α	e	□ 150...
L	UHM 10	UHM 10 HX	UHM 10 TX+	UHM 20	UHM 20 HPX	UHM 20 TX+						
R												

STANDARD-LINE

3006-2-6-60 L ...	3006-2-6-60 R ...			■	■	■	0.25-2	2	6	60°	0.035	3000...
3006-2-6-55 L ...	3006-2-6-55 R ...			■	■	■	0.25-2	2	6	55°	0.035	3000...
3006-3-10-60 L ...	3006-3-10-60 R ...			■	■	■	0.25-2	3	10	60°	0.035	3000...
3006-3-10-55 L ...	3006-3-10-55 R ...			■	■	■	0.25-2	3	10	55°	0.035	3000...

Recommendations for thread cutting □ 170



Radius-grooving

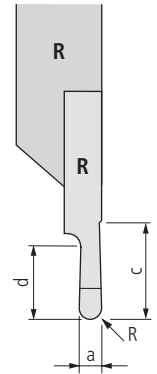
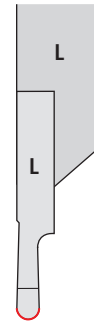
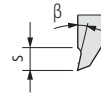

3007...

Order designation	Carbide						Dimensions						Holder
	-	-	●	○	●	●	a	c	d	β	R	s	□ 150...
L	UHM 10	UHM 10 HX	UHM 10 TX+	UHM 20	UHM 20 HPX	UHM 20 TX+							

PREMIUM-LINE

3007-R0.25-2-10 L ...	3007-R0.25-2-10 R ...			■	■	■	0.5	12	2	6°	0.25	2	3000...
-----------------------	-----------------------	--	--	---	---	---	-----	----	---	----	------	---	---------

STANDARD-LINE

3007-R0.5-2.5-10 L ...	3007-R0.5-2.5-10 R ...			■	■	■	1	12	2.5	6°	0.5	2	3000...
3007-R0.6-2.5-10 L ...	3007-R0.6-2.5-10 R ...			■	■	■	1.2	12	2.5	6°	0.6	2	3000...
3007-R0.75-3-10 L ...	3007-R0.75-3-10 R ...			■	■	■	1.5	12	3	6°	0.75	2	3000...
3007-R0.8-3-10 L ...	3007-R0.8-3-10 R ...			■	■	■	1.6	12	3	6°	0.8	2	3000...
3007-R1.0-10 L ...	3007-R1.0-10 R ...			■	■	■	2	12	10	6°	1	2	3000...
3007-R1.5-10 L ...	3007-R1.5-10 R ...			■	■	■	3	12	10	6°	1.5	2	3000...
3007-R1.5-16 L ...	3007-R1.5-16 R ...			■	■	■	3	17	16	6°	1.5	2	3000...

Chamfering

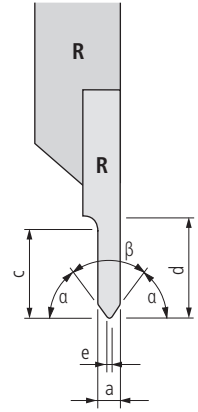
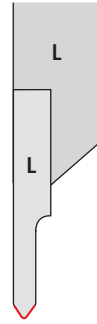

3012...

Order designation	Carbide						Dimensions						Holder
	-	-	●	○	●	●	a	c	d	a	β	e	□ 150...
L	○	●	●	○	●	●							
R	-	○	-	-	○	-							
	UHM 10	UHM 10 HX	UHM 10 TX+	UHM 20	UHM 20 HPX	UHM 20 TX+							

STANDARD-LINE

3012-2-6-60 L ...	3012-2-6-60 R ...				■	■	■	2	2	10	60°	60°	0.035	3000...
3012-2-10-45 L ...	3012-2-10-45 R ...				■	■	■	2	10	12	45°	90°	-	3000...

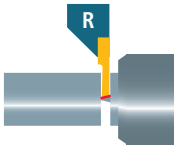

Standard

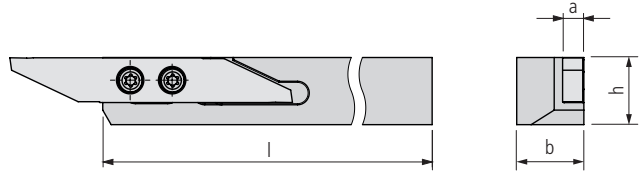

3000...

Order designation		Dimensions								Inserts
L	R	h	b	l	a					□ 113...

STANDARD-LINE

3000-08x80 L	■	3000-08x80 R	■	8	8	80	3.5					30...
3000-08x100 L	■	3000-08x100 R	■	8	8	100	3.5					30...
3000-10x80 L	■	3000-10x80 R	■	10	10	80	3.5					30...
3000-10x100 L	■	3000-10x100 R	■	10	10	100	3.5					30...
3000-12x100 L	■	3000-12x100 R	■	12	12	100	3.5					30...
3000-16x125 L	■	3000-16x125 R	■	16	16	125	3.5					30...
3000-20x125 L	■	3000-20x125 R	■	20	20	125	3.5					30...
3000-25x150 L	■	3000-25x150 R	■	25	25	150	3.5					30...

VALUE-LINE

3000 B-10x100 L	■	3000 B-10x100 R	■	10	10	100	3					30...
3000 B-12x100 L	■	3000 B-12x100 R	■	12	12	100	3					30...
3000 B-16x125 L	■	3000 B-16x125 R	■	16	16	125	3					30...

3000... INCH

Order designation		Dimensions								Inserts
L	R	h	b	l	a					□ 113...

STANDARD-LINE

3000-3/8"x80 L	■	3000-3/8"x80 R	■	9.525	9.525	80	3.5					30...
3000-3/8"x100 L	■	3000-3/8"x100 R	■	9.525	9.525	100	3.5					30...
3000-1/2"x100 L	■	3000-1/2"x100 R	■	12.7	12.7	100	3.5					30...
3000-5/8"x125 L	■	3000-5/8"x125 R	■	15.875	15.875	125	3.5					30...
3000-3/4"x125 L	■	3000-3/4"x125 R	■	19.05	19.05	125	3.5					30...

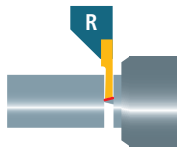

With internal cooling



*3002...-13 = $z^1 + 5$ mm
 3002...-16 = $z^1 + 5$ mm

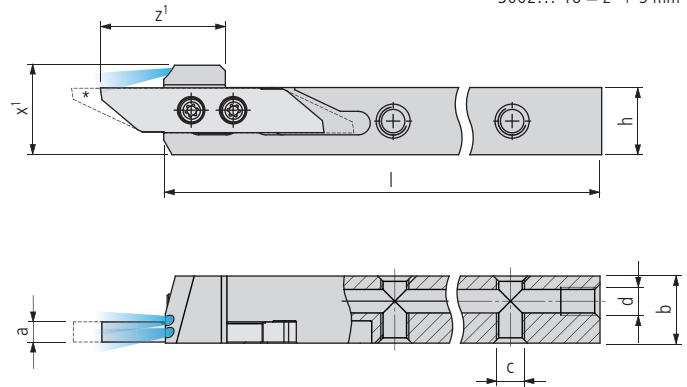

3000... IC

Order designation		Dimensions										Inserts
L	R	h	b	l	a	z ¹	x ¹	c	d	□113...		

PREMIUM-LINE

3000-08x100 L IC	■	3000-08x100 R IC	■	8	12	100	3.5	21	12.2	M5	M5	30...
3000-10x100 L IC	■	3000-10x100 R IC	■	10	12	100	3.5	21	14	M5	M5	30...
3000-12x100 L IC	■	3000-12x100 R IC	■	12	12	100	3.5	21	16	M5	M5	30...
3000-16x125 L IC	■	3000-16x125 R IC	■	16	16	125	3.5	21	20	M5	G ¹ / ₈ "	30...
3000-20x125 L IC	■	3000-20x125 R IC	■	20	20	125	3.5	21	24	M5	G ¹ / ₈ "	30...
3000-25x125 L IC	■	3000-25x125 R IC	■	25	25	125	3.5	21	29	M5	G ¹ / ₈ "	30...

3000... IC INCH

Order designation		Dimensions										Inserts
L	R	h	b	l	a	z ¹	x ¹	c	d	□113...		

PREMIUM-LINE

3000-3/8"x100 L IC	■	3000-3/8"x100 R IC	■	9.525	9.525	100	3.5	21	13.5	M5	M5	30...
3000-1/2"x100 L IC	■	3000-1/2"x100 R IC	■	12.7	12.7	100	3.5	21	16.7	M5	M5	30...
3000-5/8"x125 L IC	■	3000-5/8"x125 R IC	■	15.875	15.875	125	3.5	21	19.9	M5	G ¹ / ₈ "	30...
3000-3/4"x125 L IC	■	3000-3/4"x125 R IC	■	19.05	19.05	125	3.5	21	23	M5	G ¹ / ₈ "	30...

Scope of delivery: Holder without coolant connector
 Coolant system □619...

RAV

With off-set shank

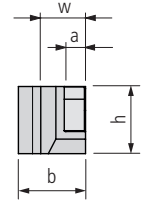
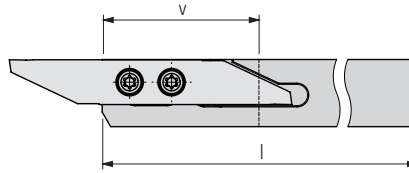

3000... AV

Order designation		Dimensions								Inserts
L	R	h	b	l	v	w	a			□113...

STANDARD-LINE

3000-10x80 LAV	■	3000-10x80 RAV	■	10	10	80	28	8	3.5			30...
3000-10x100 LAV	■	3000-10x100 RAV	■	10	10	100	28	8	3.5			30...
3000-12x100 LAV	■	3000-12x100 RAV	■	12	12	100	28	8	3.5			30...
3000-16x125 LAV	■	3000-16x125 RAV	■	16	16	125	28	8	3.5			30...

3000... AV INCH

Order designation		Dimensions								Inserts
L	R	h	b	l	v	w	a			□113...

STANDARD-LINE

3000-3/8"x80 LAV	■	3000-3/8"x80 RAV	■	9.525	9.525	80	28	8	3.5			30...
3000-3/8"x100 LAV	■	3000-3/8"x100 RAV	■	9.525	9.525	100	28	8	3.5			30...
3000-1/2"x100 LAV	■	3000-1/2"x100 RAV	■	12.7	12.7	100	28	8	3.5			30...
3000-5/8"x125 LAV	■	3000-5/8"x125 RAV	■	15.85	15.875	125	28	8	3.5			30...

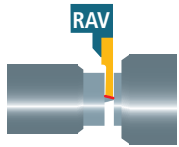

With off-set shank and internal cooling



*3002...-13 = $z^1 + 5$ mm
 3002...-16 = $z^1 + 5$ mm

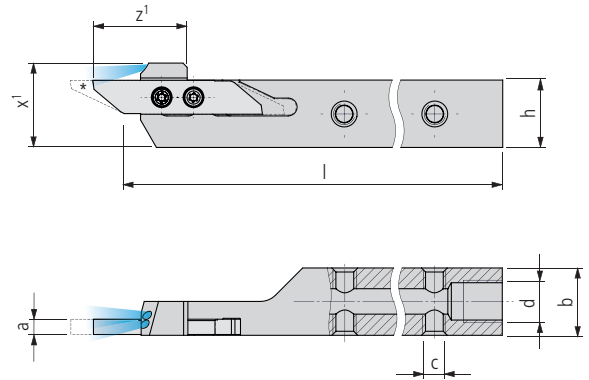

3000... AV IC

Order designation		Dimensions									Inserts	
L	R	h	b	l	a	z^1	x^1	c	d	□ 113...		
PREMIUM-LINE												
3000-16x125 LAV IC	■	3000-16x125 RAV IC	■	16	16	125	3.5	22	20	M5	G $\frac{1}{8}$ "	30...

3000... AV IC INCH

Order designation		Dimensions									Inserts	
L	R	h	b	l	a	z^1	x^1	c	d	□ 113...		
PREMIUM-LINE												
3000-5/8"x125 LAV IC	■	3000-5/8"x125 RAV IC	■	15.875	15.875	125	3.5	22	20	M5	G $\frac{1}{8}$ "	30...

Scope of delivery: Holder without coolant connector
 Coolant system □ 619...

Note

This holder type is available with interior cooling from a shank cross section of 16 mm or $\frac{5}{8}$ " .

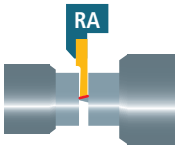

With off-set shank and insert seat

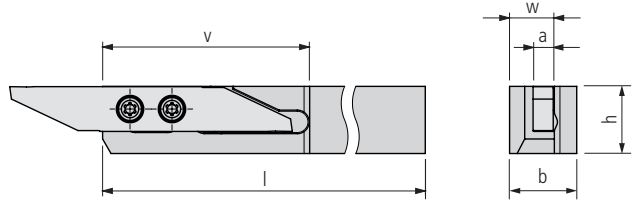

3000... A

Order designation		Dimensions								Inserts	
L	R	h	b	l	v	w	a			□ 113...	
STANDARD-LINE											
3000-10x80 LA	■ 3000-10x80 RA	■	10	10	80	37	8	3.5			30...
3000-10x100 LA	■ 3000-10x100 RA	■	10	10	100	37	8	3.5			30...
3000-12x100 LA	■ 3000-12x100 RA	■	12	12	100	37	8	3.5			30...
3000-16x125 LA	■ 3000-16x125 RA	■	16	16	125	37	8	3.5			30...

3000... A INCH

Order designation		Dimensions								Inserts	
L	R	h	b	l	v	w	a			□ 113...	
STANDARD-LINE											
3000-3/8"x80 LA	■ 3000-3/8"x80 RA	■	9.525	9.525	80	37	8	3.5			30...
3000-3/8"x100 LA	■ 3000-3/8"x100 RA	■	9.525	9.525	100	37	8	3.5			30...
3000-1/2"x100 LA	■ 3000-1/2"x100 RA	■	12.7	12.7	100	37	8	3.5			30...
3000-5/8"x125 LA	■ 3000-5/8"x125 RA	■	15.875	15.875	125	37	8	3.5			30...

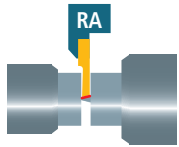

With off-set shank, insert seat and internal cooling

*3002...-13 = $z^1 + 5$ mm
 3002...-16 = $z^1 + 5$ mm

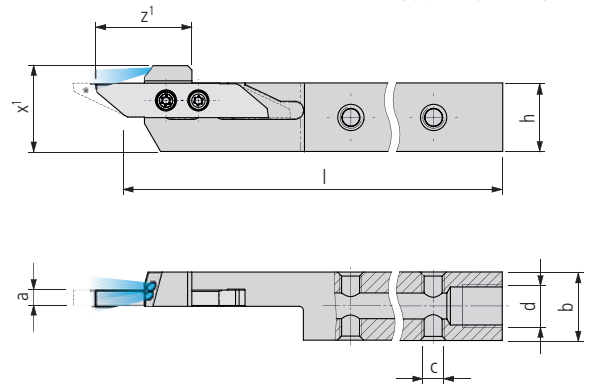

3000... A IC

Order designation		Dimensions									Inserts	
L	R	h	b	l	a	z^1	x^1	c	d	□ 113...		
PREMIUM-LINE												
3000-16x125 LA IC	■	3000-16x125 RA IC	■	16	16	125	3.5	22	20	M5	G $\frac{1}{8}$ "	30...

3000... A IC INCH

Order designation		Dimensions									Inserts	
L	R	h	b	l	a	z^1	x^1	c	d	□ 113...		
PREMIUM-LINE												
3000-5/8"x125 LA IC	■	3000-5/8"x125 RA IC	■	15.875	15.875	125	3.5	22	20	M5	G $\frac{1}{8}$ "	30...

Scope of delivery: Holder without coolant connector
 Coolant system 619...

Note

This holder type is available with interior cooling from a shank cross section of 16 mm or $\frac{5}{8}$ " .

Clamping of insert from the back side

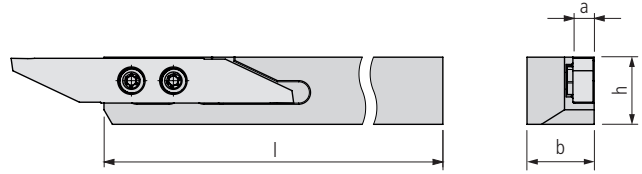
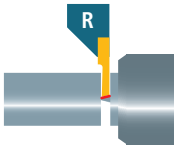

3000... C (Combi)

Order designation		Dimensions								Inserts
L	R	h	b	l	a					□ 113...

STANDARD-LINE

3000-08x100 LC	■	3000-08x100 RC	■	8	8	100	3.5					30...
3000-10x100 LC	■	3000-10x100 RC	■	10	10	100	3.5					30...
3000-12x100 LC	■	3000-12x100 RC	■	12	12	100	3.5					30...
3000-16x125 LC	■	3000-16x125 RC	■	16	16	125	3.5					30...
3000-20x125 LC	■	3000-20x125 RC	■	20	20	125	3.5					30...

3000... C (Combi) INCH

Order designation		Dimensions								Inserts
L	R	h	b	l	a					□ 113...

STANDARD-LINE

3000-3/8"x100 LC	■	3000-3/8"x100 RC	■	9.525	9.525	100	3.5					30...
3000-1/2"x100 LC	■	3000-1/2"x100 RC	■	12.7	12.7	100	3.5					30...
3000-5/8"x125 LC	■	3000-5/8"x125 RC	■	15.875	15.875	125	3.5					30...
3000-3/4"x125 LC	■	3000-3/4"x125 RC	■	19.05	19.05	125	3.5					30...

Clamping of the insert on holder 3000... C □ 157

The regular tool holder multidec®-CUT 3000 uses the insert fixing screws from the side of the insert. The tool holder CUT 3000 C "Combi" allows in addition the insert fixing screws to be mounted from the opposite side using tapped bushings.

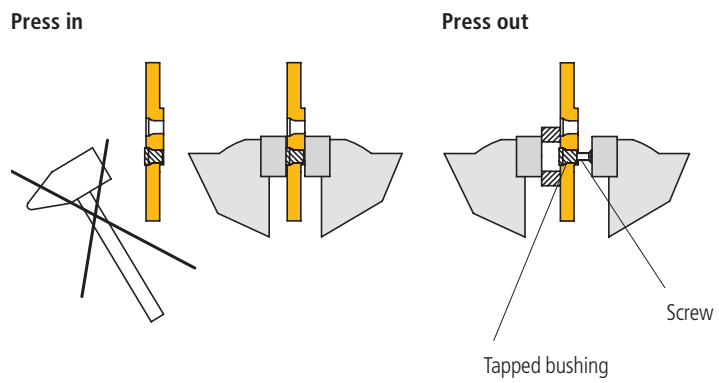
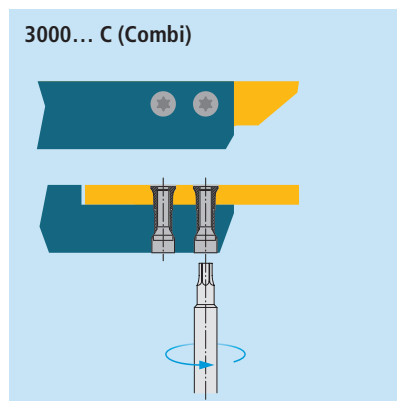
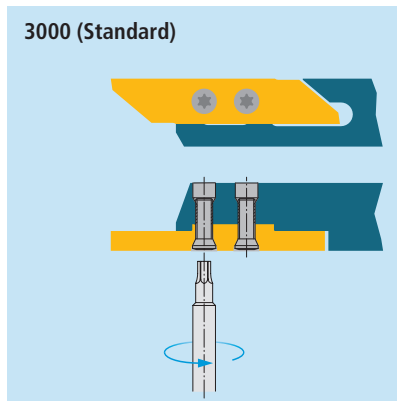

To avoid damage don't use excessive force while inserting and removing the tapped bushing.

With off-set shank for machines with a revolving turret

* 3002...-13 = $z^1 + 5$ mm
 3002...-16 = $z^1 + 5$ mm

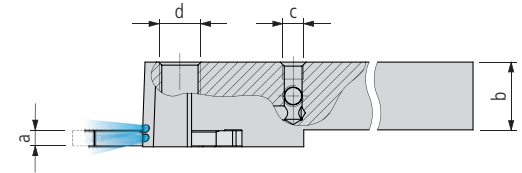
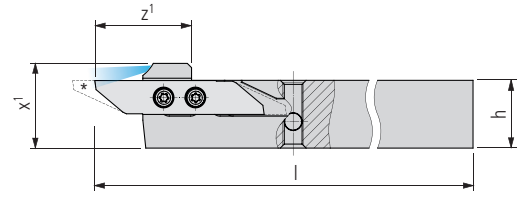
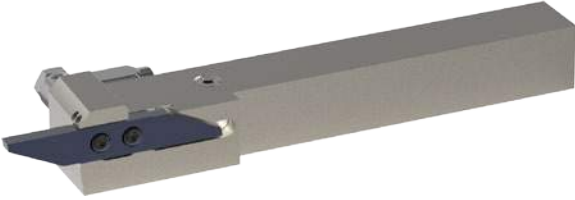
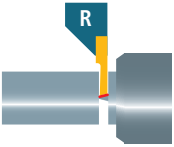

3000 AK... IC

Order designation		Dimensions								Inserts
L	R	h	b	l	a	z_1	x_1	c	d	□113...

STANDARD-LINE



3000 AK-16x125 L IC	■	3000 AK-16x125 R IC	■	16	16	125	3.5	23	20	M5	G $\frac{1}{8}$ "	30...
3000 AK-20x125 L IC	■	3000 AK-20x125 R IC	■	20	20	125	3.5	23	24	M5	G $\frac{1}{8}$ "	30...
3000 AK-25x125 L IC	■	3000 AK-25x125 R IC	■	25	25	125	3.5	23	29	M5	G $\frac{1}{8}$ "	30...

3000 AK... IC INCH

Order designation		Dimensions								Inserts
L	R	h	b	l	a	z_1	x_1	c	d	□113...

STANDARD-LINE

3000 AK-5/8"x125 R IC	■	3000 AK-5/8"x125 L IC	■	15.875	15.875	125	3.5	23	19.875	M5	G $\frac{1}{8}$ "	30...
3000 AK-3/4"x125 R IC	■	3000 AK-3/4"x125 L IC	■	19.05	19.05	125	3.5	23	23.05	M5	G $\frac{1}{8}$ "	30...
3000 AK-1"x125 R IC	■	3000 AK-1"x125 L IC	■	25.4	25.4	125	3.5	23	29.4	M5	G $\frac{1}{8}$ "	30...

Illustration	Description	Dimensions	Order designation	Holder
	TORX screw	M2.5 × 9 T08	MSP 25090 T08	3000...C
		M3 × 7.3 T08	MSP 30073 T08	3000-08...* 3000...A
		M3 × 9 T08	MSP 30090 T08	3000...**
	Tapped bushing Ø 3.55	M2.5 × 4	MSP 25040 GB2	3000...C

C: Combi; A: offset shank

* Holder up to shank width of 8 mm

** Holder from shank width of 10 mm

TORX screwdriver 651...



A turn and cut-off tool for Swiss type lathes up to bar diameter 20 mm. The cutting inserts consist of two cutting edges. The insert seat, which is protected against contamination permits 100 % utilization of all cutting edges.

Even for holders a wide range of possibilities with shank sizes between 8 and 25 mm are available. For Swiss type automatic lathes special holders have been designed and complete the wide range of choices.

Advantages:

- System for grooving large and wide forms up to 6 mm
- The machine operator can grind his own cutting geometries



"IC" tool holder with integrated cooling



Cost-efficient processing of modern materials increasingly requires accurate control of the coolant at the cutting edge. Conveying the coolant as close as possible to the cutting edge is often a difficult task in the machine rooms of Swiss type turning lathes.

The multidec®-IC program offers a wide range of holders with integrated cooling. Because of the high precision and pressure, it is possible to discharge the chip quickly and safely from the cutting edge and the workpiece, which protects the cutting edge of the insert. This means significantly longer tool life as well as very reliable serial production.

Advantages:

- All holders feature five possible connectors for the coolant supply
- Fixed coolant exit allows for small set-up in front of the holder
- With or without high pressure, the coolant medium always hits the cutting edge precisely

Overview – multidec®-CUT 3600

Technical information		11
Inserts		
3601...		162
3605...		163
Holder		
3600..., 3600... IC		164
Replacement and spare parts		166

Blank

162

UTILIS
multidec[®]
swiss type tools

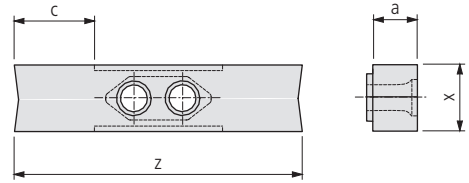

3601...

Order designation	Material					Dimensions				Holder
	Carbide	□ 20	HSS			a	c	x	z	
L	○	●	●	●	●					□ 164...
	○	●	●	●	○					
	○	●	●	●	○					
	●	○	○	○	○					
	○	○	○	○	○					
	UHM 20	UHM 20 HPX	UHM 20 TX+	HSS	HSS HX					
PREMIUM-LINE										
3601-6-10 NP ... *	■	■	■			6	11	8	40.5	3600...
STANDARD-LINE										
3601-6-10 N ...	■	■	■	■	■	6	11	8	40.5	3600...

* Mirror polished



Grooving and turning

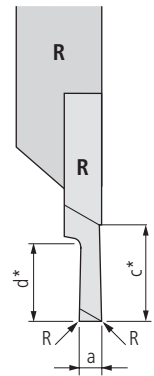
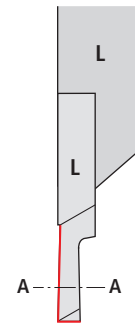
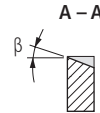

3605... CP

Order designation	Carbide			Holder	Dimensions				
	UHM 20	UHM 20 HPX	UHM 20 TX+		a	c*	d*	R	β
	○	●	●	□ 164...					
	○	●	●						
	○	●	●						
	●	○	-						
	-	-	○						

STANDARD-LINE

3605-4.0-10 L CP ...	3605-4.0-10 R CP ...	■	■	■	4	10	10	-	10°		3600...
3605-4.0-10 L CP R08 ...	3605-4.0-10 R CP R08 ...	■	■	■	4	10	10	0.08	10°		3600...
3605-4.0-10 L CP R15 ...	3605-4.0-10 R CP R15 ...	■	■	■	4	10	10	0.15	10°		3600...

* c: maximal turning capacity
d: maximal grooving capacity

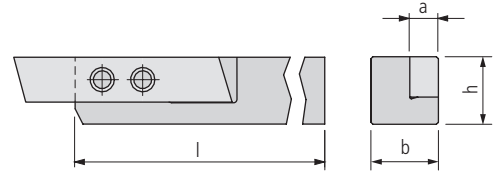

3600...

Order designation		Dimensions								Inserts
L	R	h	b	l	a					□ 162...

STANDARD-LINE

3600-10x80 L	■	3600-10x80 R	■	10	10	80	6					36...
3600-10x100 L	■	3600-10x100 R	■	10	10	100	6					36...
3600-12x100 L	■	3600-12x100 R	■	12	12	100	6					36...
3600-16x125 L	■	3600-16x125 R	■	16	16	125	6					36...
3600-20x125 L	■	3600-20x125 R	■	20	20	125	6					36...
3600-25x150 L	■	3600-25x150 R	■	25	25	150	6					36...

3600... INCH

Order designation		Dimensions								Inserts
L	R	h	b	l	a					□ 162...

STANDARD-LINE

3600-3/8"x80 L	■	3600-3/8"x80 R	■	9.525	9.525	80	6					36...
3600-3/8"x100 L	■	3600-3/8"x100 R	■	9.525	9.525	100	6					36...
3600-1/2"x100 L	■	3600-1/2"x100 R	■	12.7	12.7	100	6					36...
3600-5/8"x125 L	■	3600-5/8"x125 R	■	15.875	15.875	125	6					36...
3600-3/4"x125 L	■	3600-3/4"x125 R	■	19.05	19.05	125	6					36...

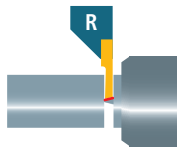

With internal cooling

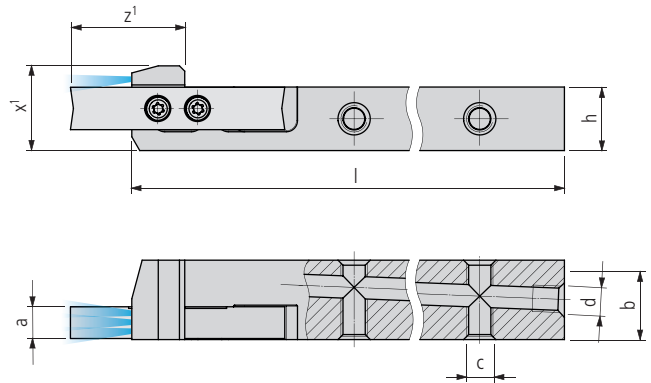

3600... IC

Order designation		Dimensions										Inserts
L	R	h	b	l	a	z¹	x¹	c	d	□ 162...		

PREMIUM-LINE

3600-1215x100 L IC	■	3600-1215x100 R IC	■	12	15	100	6	21	16	M5	M5	36...
3600-16x125 L IC	■	3600-16x125 R IC	■	16	16	125	6	21	20	M5	G½"	36...
3600-20x125 L IC	■	3600-20x125 R IC	■	20	20	125	6	21	24	M5	G½"	36...
3600-25x125 L IC	■	3600-25x125 R IC	■	25	25	125	6	21	29	M5	G½"	36...

3600... IC INCH

Order designation		Dimensions										Inserts
L	R	h	b	l	a	z¹	x¹	c	d	□ 162...		

PREMIUM-LINE

3600-1/2"15x100 L IC	■	3600-1/2"15x100 R IC	■	12.7	15	100	6	21	16.7	M5	M5	36...
3600-5/8"x125 L IC	■	3600-5/8"x125 R IC	■	15.875	15.875	125	6	21	19.9	M5	G½"	36...
3600-3/4"x125 L IC	■	3600-3/4"x125 R IC	■	19.05	19.05	125	6	21	23	M5	G½"	36...

Scope of delivery: Holder without coolant connector
 Coolant system □ 619...

Illustration	Description	Dimensions	Order designation	Holder
	TORX PLUS screw	M3 × 9 T08	MSP 30090 T08	3600-10.../3600-3/8" ... *
		M3 × 11 TP09	MSP 30110 TP09	3600... **

* Holder up to shank width of 10 mm

** Holder from shank width of 12 mm

TORX screwdriver 651...

	Steel unalloyed			Steel low alloyed			Steel high alloyed		
Hardness value (HB)/(HRC)	125–300 HB			180–250 HB			200–350 HB		
Category	I			II			III		
Machining method	▼	▼▼	▼▼▼	▼	▼▼	▼▼▼	▼	▼▼	▼▼▼
Feeds	f (mm/rev)								
	0.1–0.25	0.02–0.15	0.005–0.08	0.1–0.25	0.02–0.15	0.005–0.08	0.1–0.25	0.02–0.15	0.005–0.08
Depths of cut	a _p (mm)								
	<5	<3	<2	<5	<3	<2	<4	<2.5	<1.5
Cutting speeds	v _c (m/min)								
Cutting material carbide									
UHM 20	40–110	60–120	60–140	60–100	60–120	60–130	40–90	60–110	60–120
UHM 20 HPX	150–200	180–220	200–260	80–150	100–180	160–220	70–100	90–150	120–180
UHM 20 TX+	–	–	–	80–130	100–150	160–190	70–90	90–130	120–150
UHM 30	30–70	50–80	50–100	30–60	40–80	40–90	–	30–70	30–80
UHM 30 HX	50–140	50–180	50–220	50–130	50–160	50–200	40–120	50–140	50–180
UHM 30 TX+	–	–	–	–	–	–	–	–	–
Cutting material HSS									
HSS	25–30	25–35	25–40	20–30	20–35	20–35	15–20	15–25	15–30
HSS HX	30–40	35–40	35–50	25–35	25–40	25–45	20–30	20–30	20–35

	Stainless steel			Stainless steel			Titanium		
Hardness value (HB)	180–220 HB			220–330 HB			–		
Category	V			VI			IV		
Machining method	▼	▼▼	▼▼▼	▼	▼▼	▼▼▼	▼	▼▼	▼▼▼
Feeds	f (mm/rev)								
	0.1–0.2	0.01–0.12	0.005–0.08	0.1–0.2	0.01–0.12	0.005–0.08	0.1–0.25	0.02–0.08	0.005–0.06
Depths of cut	a _p (mm)								
	<4	<2.5	<1.5	<4	<2.5	<1.5	<4	<2.5	<1.5
Cutting speeds	v _c (m/min)								
Cutting material carbide									
UHM 20	40–100	40–110	40–120	30–70	30–80	30–80	40–60	50–70	60–80
UHM 20 HPX	90–150	110–180	160–200	70–90	90–120	110–150	50–100	60–120	60–140
UHM 20 TX+	90–130	110–160	160–180	70–90	90–120	110–150	50–100	60–120	60–140
UHM 30	–	30–70	30–80	–	20–40	20–40	–	25–60	30–70
UHM 30 HX	40–100	40–140	40–180	30–60	40–70	40–90	30–90	40–100	40–120
UHM30 TX+	–	–	–	–	–	–	–	–	–
Cutting material HSS									
HSS	15–20	15–25	15–30	10–20	15–20	15–25	10–20	15–20	15–25
HSS HX	20–30	20–30	20–35	20–30	20–30	20–35	20–30	20–30	20–35

	Aluminum			Brass			Hard materials		
Hardness value (HB)/(HRC)	60–130 HB			–			45–70 HRC		
Category	VII			VIII			X		
Machining method	▼	▼▼	▼▼▼	▼	▼▼	▼▼▼	▼	▼▼	▼▼▼
Feeds	f (mm/rev)								
	0.1–0.3	0.02–0.25	0.005–0.20	0.1–0.3	0.02–0.15	0.005–0.10	–	–	–
Depths of cut									
	<5	<3	<2	<5	<3	<2	–	–	–
Cutting speeds									
Cutting material carbide									
UHM 20	100–1500	120–2000	160–2500	80–300	100–400	120–500	–	–	–
UHM 20 HPX	–	–	–	–	–	–	–	–	–
UHM 20 TX+	–	–	–	–	–	–	–	–	–
UHM 30	50–1000	60–1200	80–1500	40–100	50–140	50–160	–	–	–
UHM 30 HX	70–1500	80–2000	100–3000	50–150	50–200	50–250	–	–	–
UHM 30 TX+	–	–	–	–	–	–	–	–	–
Cutting material HSS									
HSS	30–80	40–80	50–90	30–50	30–60	40–70	–	–	–
HSS HX	40–90	50–100	50–120	40–60	40–80	50–90	–	–	–

Properties and applications

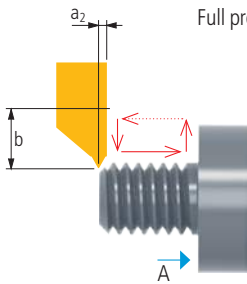

Full profile threading inserts 1606... VP / 3006... VP up to pitch of 0.45 mm

Properties:

- Insert front side ground far back (b)
- At a minimum reduced distance between the thread tip and front side (a_2)

This makes it possible to move extremely close to the shoulder (A) with an extremely narrow or non-existent undercut.

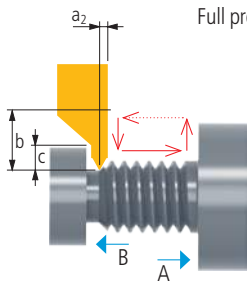

Full profile threading inserts 1606... VP / 3006... VP from pitch of 0.5 mm

Properties:

- Insert front side ground far back (b)
- At a minimum reduced distance between the thread tip and front side (a_2)
- Back of insert ground free towards the rear (c)

This makes it possible to move extremely close to the shoulder (A) with an extremely narrow or non-existent undercut. This version also makes it possible to manufacture a thread behind a shoulder (B).

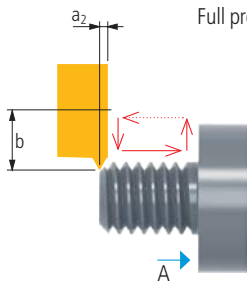

Full profile threading inserts, reinforced 3006... VP – from pitch of 0.25 mm

Properties:

- Insert front side ground far back (b)
- At a minimum reduced distance between the thread tip and front side (a_2)
- Reinforcement of the threading profile using a special cut

The reinforcement makes it possible to reduce the number of passes by up to 20 %. It is possible to move extremely close to the shoulder (A) with an extremely narrow or non-existent undercut.

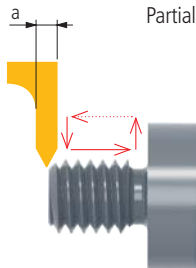

Partial profile threading inserts 1606... / 3006... with pitch of 0.25–2 mm

Properties:

- Front of insert with wide partial profile cut (a) for covering a bigger pitch area

This makes it possible to manufacture various pitches with the same indexable insert, but requires an undercut for smaller pitches.

Number of passes

Pitch (mm)	(T/Inch)	0.06–0.09	0.1–0.35	0.4	0.45	0.5	0.75	0.8	1	1.25	1.5	1.75	2–2.5
		–	80/72	64	56	48/44	40/36	32	28/24	20/19	18/16	14	13/11
Steel		2–4	3–5	3–6	3–7	5–8	5–9	6–9	6–10	7–11	8–12	9–13	12–15
Stainless steel		2–4	4–6	5–6	5–7	6–9	6–10	6–11	7–12	8–13	9–14	12–15	13–18
Titanium		2–5	4–7	5–6	5–7	6–9	6–10	6–11	7–13	8–14	9–14	12–15	13–19
Non-ferrous metal		2–4	3–5	3–6	3–7	3–8	4–9	5–10	6–11	7–14	8–16	9–16	11–17
Hard materials		3–6	4–7	5–8	6–9	8–10	9–12	10–15	11–17	13–20	18–22	20–26	25–30

Choice of feed movement

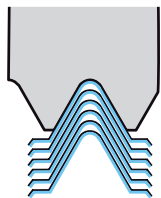

Radial feed

Applicability:

- for conventional lathes
- for piches < 2 mm
- short chipping materials

Disadvantage:

- poor chip control

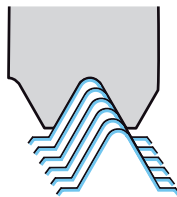

Feed on the flanks

Applicability:

- for CNC lathes
- for piches 2 to 4 mm
- long chipping materials
- good chip control

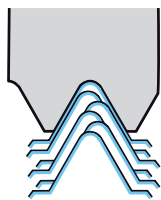

Alternated feed

Applicability:

- for piches > 4 mm
- long chipping materials
- regular wear of insert
- high tool-life
- good chip control

Disadvantage:

- complex CNC-programming

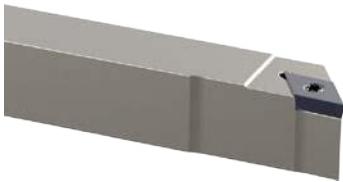

multidec®-ISO provides a very wide range of ISO standardized inserts for Swiss type machining and precision turning. All inserts consist of two or more edges and are easily indexed or changed. All inserts have several cutting edges and are easily replaceable. At the same time, multidec®-ISO provides sharp and rounded cutting edges with radii between 0 and 0.8 mm. Innovative solutions involving coated and uncoated inserts made of carbide, cermets and diamond tips have been designed to cut very difficult materials. For all mechanical cutting conditions a large choice of sintered and ground inserts with a wide variety of chip grooves are available. Even for the holders a wide range of possibilities with shank sizes between 8 and 25 mm are available. For Swiss type automatic lathes special holders have been designed and complete the wide range of choices.

Advantages:

- Large range of standard ISO inserts
- Sharp cutting edges "F"
- Rounded cutting edges "E"
- Small corner radius (0–0.8 mm)
- Especially designed holders for CNC Swiss type automatic lathes (sizes 8×8 to 25×25 mm)

The versatility of the materials which are machined in a modern production facility requires suitable chip breakers and also a wider variety of cutting edge types, carbide grades and coatings. Our range of ISO inserts has been supplemented with the introduction of the new "PF05" insert and the addition of cutting geometries "A3", "PF23" and "PF33".

New chip breaker for materials with difficult chip breaking behaviour



FN-PF05

Precision grinding with ISO-E tolerance at the centre height and at the inner circle, together with an extremely wear-resistant substrate and modern coating, make this insert a real problem-solver for the machining of stainless steels and super-alloys.

Advantages:

- High insert change repeat accuracy
- Sharp cutting edge despite coating

New versions of existing inserts

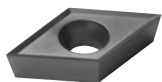

**EN-A3
FN-A3**

EN-... : With rounded cutting edge "E"
FN-... : With sharp cutting edge "F"



**EN-PF23
FN-PF23**

The proven chip breakers A3, PF23 and PF33 are now also available with a slightly rounded cutting edge. New carbide grades and a new high performance coating have also been introduced for all of these inserts.





This wide range of options will increase your flexibility in choosing the right cutting edge tremendously, and provide a suitable solution for all materials.

Advantages:

- A much wider range of workpieces can be processed.
- Bigger feeds and cutting depths are possible with rounded cutting edges
- Substrates that are both wear-resistant and extremely tough are available.
- Optimally coordinated coatings for high performance.

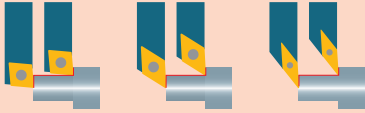
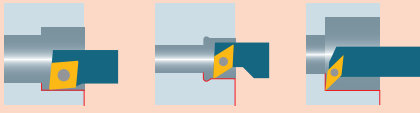
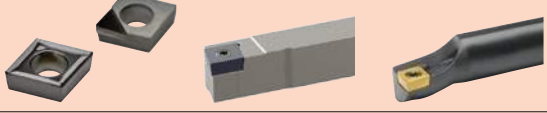

**EN-PF33
FN-PF33**

Technical information		11																																																																																																																																																																								
Application OD turning		174																																																																																																																																																																								
Application ID turning		175																																																																																																																																																																								
Overview type CC... (80°)		177																																																																																																																																																																								
Overview type DC... (55°)		201																																																																																																																																																																								
Overview type DN... (55°)		249																																																																																																																																																																								
Overview type VC... (35°)		259																																																																																																																																																																								
Cutting specification	<table border="1"> <thead> <tr> <th></th> <th>Spindel-Längsgraben Ausschnitt 180°</th> <th>Spindel-Längsgraben Ausschnitt 90°</th> <th>Spindel-Längsgraben Ausschnitt 45°</th> <th>Spindel-Längsgraben Ausschnitt 30°</th> <th>Spindel-Längsgraben Ausschnitt 15°</th> <th>Spindel-Längsgraben Ausschnitt 0°</th> </tr> </thead> <tbody> <tr> <td>ISO 1835 DIN 66016 ISO 1835-1 (Teil 1) (ISO)</td> <td>110-180</td> <td>180-250</td> <td>250-350</td> <td></td> <td></td> <td></td> </tr> <tr> <td>Materialgruppe</td> <td>I</td> <td>II</td> <td>III</td> <td>IV</td> <td>V</td> <td>VI</td> </tr> <tr> <td>Bohrverfahren</td> <td>▽</td> <td>▽</td> <td>▽</td> <td>▽</td> <td>▽</td> <td>▽</td> </tr> <tr> <td>Bohrer</td> <td>▽</td> <td>▽</td> <td>▽</td> <td>▽</td> <td>▽</td> <td>▽</td> </tr> <tr> <td>Bohrerlänge</td> <td>▽</td> <td>▽</td> <td>▽</td> <td>▽</td> <td>▽</td> <td>▽</td> </tr> <tr> <td>Bohrermaterial</td> <td>▽</td> <td>▽</td> <td>▽</td> <td>▽</td> <td>▽</td> <td>▽</td> </tr> <tr> <td>Bohrergröße</td> <td>▽</td> <td>▽</td> <td>▽</td> <td>▽</td> <td>▽</td> <td>▽</td> </tr> <tr> <td>Bohrerart</td> <td>▽</td> <td>▽</td> <td>▽</td> <td>▽</td> <td>▽</td> <td>▽</td> </tr> <tr> <td>Bohrerlänge</td> <td>▽</td> <td>▽</td> <td>▽</td> <td>▽</td> <td>▽</td> <td>▽</td> </tr> <tr> <td>Bohrergröße</td> <td>▽</td> <td>▽</td> <td>▽</td> <td>▽</td> <td>▽</td> <td>▽</td> </tr> <tr> <td>Bohrerart</td> <td>▽</td> <td>▽</td> <td>▽</td> <td>▽</td> <td>▽</td> <td>▽</td> </tr> <tr> <td>Bohrerlänge</td> <td>▽</td> <td>▽</td> <td>▽</td> <td>▽</td> <td>▽</td> <td>▽</td> </tr> <tr> <td>Bohrergröße</td> <td>▽</td> <td>▽</td> <td>▽</td> <td>▽</td> <td>▽</td> <td>▽</td> </tr> <tr> <td>Bohrerart</td> <td>▽</td> <td>▽</td> <td>▽</td> <td>▽</td> <td>▽</td> <td>▽</td> </tr> <tr> <td>Bohrerlänge</td> <td>▽</td> <td>▽</td> <td>▽</td> <td>▽</td> <td>▽</td> <td>▽</td> </tr> <tr> <td>Bohrergröße</td> <td>▽</td> <td>▽</td> <td>▽</td> <td>▽</td> <td>▽</td> <td>▽</td> </tr> <tr> <td>Bohrerart</td> <td>▽</td> <td>▽</td> <td>▽</td> <td>▽</td> <td>▽</td> <td>▽</td> </tr> <tr> <td>Bohrerlänge</td> <td>▽</td> <td>▽</td> <td>▽</td> <td>▽</td> <td>▽</td> <td>▽</td> </tr> <tr> <td>Bohrergröße</td> <td>▽</td> <td>▽</td> <td>▽</td> <td>▽</td> <td>▽</td> <td>▽</td> </tr> <tr> <td>Bohrerart</td> <td>▽</td> <td>▽</td> <td>▽</td> <td>▽</td> <td>▽</td> <td>▽</td> </tr> <tr> <td>Bohrerlänge</td> <td>▽</td> <td>▽</td> <td>▽</td> <td>▽</td> <td>▽</td> <td>▽</td> </tr> <tr> <td>Bohrergröße</td> <td>▽</td> <td>▽</td> <td>▽</td> <td>▽</td> <td>▽</td> <td>▽</td> </tr> <tr> <td>Bohrerart</td> <td>▽</td> <td>▽</td> <td>▽</td> <td>▽</td> <td>▽</td> <td>▽</td> </tr> </tbody> </table>		Spindel-Längsgraben Ausschnitt 180°	Spindel-Längsgraben Ausschnitt 90°	Spindel-Längsgraben Ausschnitt 45°	Spindel-Längsgraben Ausschnitt 30°	Spindel-Längsgraben Ausschnitt 15°	Spindel-Längsgraben Ausschnitt 0°	ISO 1835 DIN 66016 ISO 1835-1 (Teil 1) (ISO)	110-180	180-250	250-350				Materialgruppe	I	II	III	IV	V	VI	Bohrverfahren	▽	▽	▽	▽	▽	▽	Bohrer	▽	▽	▽	▽	▽	▽	Bohrerlänge	▽	▽	▽	▽	▽	▽	Bohrermaterial	▽	▽	▽	▽	▽	▽	Bohrergröße	▽	▽	▽	▽	▽	▽	Bohrerart	▽	▽	▽	▽	▽	▽	Bohrerlänge	▽	▽	▽	▽	▽	▽	Bohrergröße	▽	▽	▽	▽	▽	▽	Bohrerart	▽	▽	▽	▽	▽	▽	Bohrerlänge	▽	▽	▽	▽	▽	▽	Bohrergröße	▽	▽	▽	▽	▽	▽	Bohrerart	▽	▽	▽	▽	▽	▽	Bohrerlänge	▽	▽	▽	▽	▽	▽	Bohrergröße	▽	▽	▽	▽	▽	▽	Bohrerart	▽	▽	▽	▽	▽	▽	Bohrerlänge	▽	▽	▽	▽	▽	▽	Bohrergröße	▽	▽	▽	▽	▽	▽	Bohrerart	▽	▽	▽	▽	▽	▽	Bohrerlänge	▽	▽	▽	▽	▽	▽	Bohrergröße	▽	▽	▽	▽	▽	▽	Bohrerart	▽	▽	▽	▽	▽	▽	302
	Spindel-Längsgraben Ausschnitt 180°	Spindel-Längsgraben Ausschnitt 90°	Spindel-Längsgraben Ausschnitt 45°	Spindel-Längsgraben Ausschnitt 30°	Spindel-Längsgraben Ausschnitt 15°	Spindel-Längsgraben Ausschnitt 0°																																																																																																																																																																				
ISO 1835 DIN 66016 ISO 1835-1 (Teil 1) (ISO)	110-180	180-250	250-350																																																																																																																																																																							
Materialgruppe	I	II	III	IV	V	VI																																																																																																																																																																				
Bohrverfahren	▽	▽	▽	▽	▽	▽																																																																																																																																																																				
Bohrer	▽	▽	▽	▽	▽	▽																																																																																																																																																																				
Bohrerlänge	▽	▽	▽	▽	▽	▽																																																																																																																																																																				
Bohrermaterial	▽	▽	▽	▽	▽	▽																																																																																																																																																																				
Bohrergröße	▽	▽	▽	▽	▽	▽																																																																																																																																																																				
Bohrerart	▽	▽	▽	▽	▽	▽																																																																																																																																																																				
Bohrerlänge	▽	▽	▽	▽	▽	▽																																																																																																																																																																				
Bohrergröße	▽	▽	▽	▽	▽	▽																																																																																																																																																																				
Bohrerart	▽	▽	▽	▽	▽	▽																																																																																																																																																																				
Bohrerlänge	▽	▽	▽	▽	▽	▽																																																																																																																																																																				
Bohrergröße	▽	▽	▽	▽	▽	▽																																																																																																																																																																				
Bohrerart	▽	▽	▽	▽	▽	▽																																																																																																																																																																				
Bohrerlänge	▽	▽	▽	▽	▽	▽																																																																																																																																																																				
Bohrergröße	▽	▽	▽	▽	▽	▽																																																																																																																																																																				
Bohrerart	▽	▽	▽	▽	▽	▽																																																																																																																																																																				
Bohrerlänge	▽	▽	▽	▽	▽	▽																																																																																																																																																																				
Bohrergröße	▽	▽	▽	▽	▽	▽																																																																																																																																																																				
Bohrerart	▽	▽	▽	▽	▽	▽																																																																																																																																																																				
Bohrerlänge	▽	▽	▽	▽	▽	▽																																																																																																																																																																				
Bohrergröße	▽	▽	▽	▽	▽	▽																																																																																																																																																																				
Bohrerart	▽	▽	▽	▽	▽	▽																																																																																																																																																																				
Special tools – multidec4you®		600																																																																																																																																																																								

Front turning

Holders 195

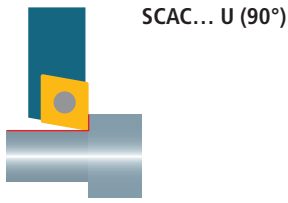

Turning

Holders 195

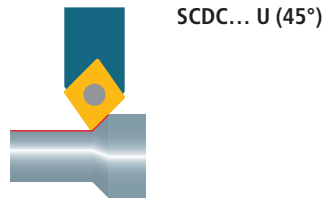

Turning and facing

Holders 196

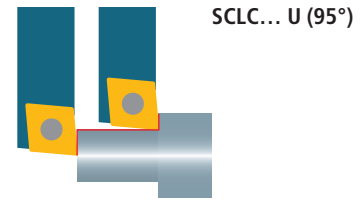

Front turning

Holders 227

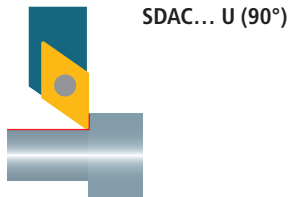

Turning and undercutting

Holders 228

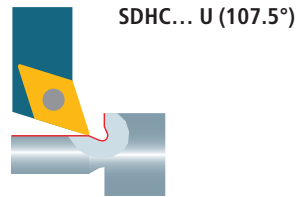

Turning and facing

Holders 230/252

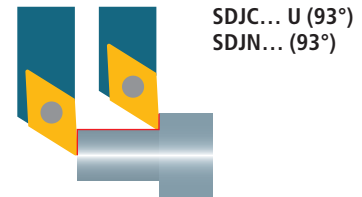

Turning and facing

Holders 234

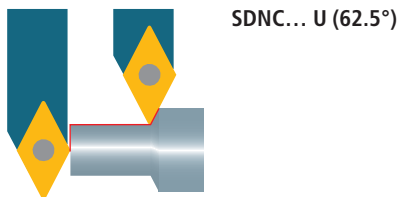

Turning

Holders 236

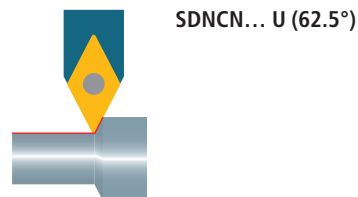

Front turning

Holders 283

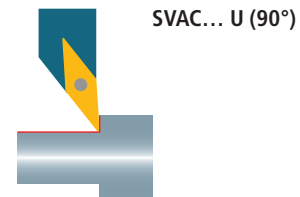

Turning and facing

Holders 284

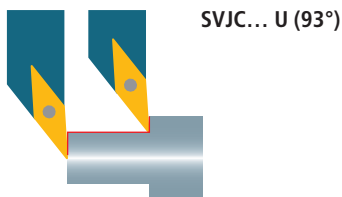

Turning and undercutting

Holders 286

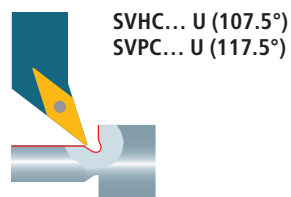

Back turning

Holders 290

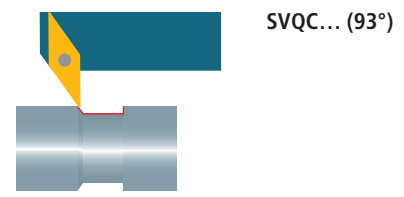

Turning and facing

Holders 291

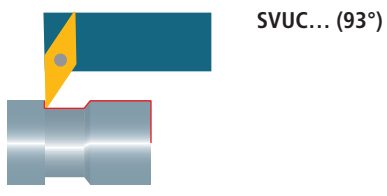

Turning

Holders 292

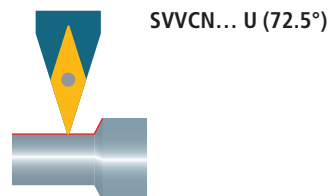

Back turning

Holders 294

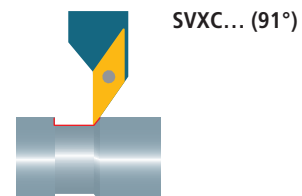

Turning and facing

Holders 198/199

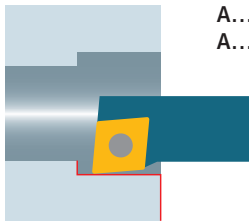

A... SCFC... (90°)
A... SCLC... (95°)

Turning and facing

Holders 242

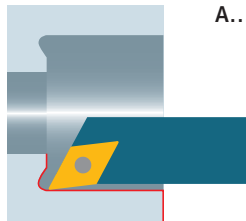

A... SDOC... (95°)

Turning and facing

Holders 243

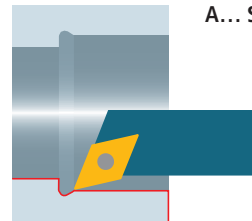

A... SDQC... (107.5°)

Turning and facing

Holders 244

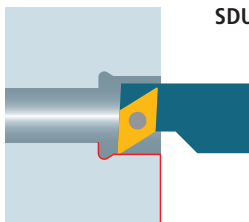

SDUC... (93°)

Turning and undercutting

Holders 298

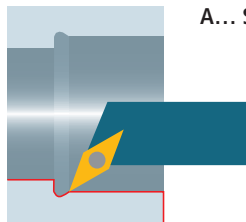

A... SVQC... (107.5°)

Turning and facing

Holders 299

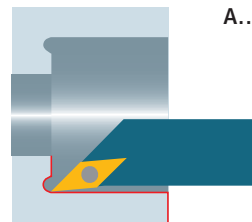

A... SVOC... (95°)

Turning and facing

Holders 300

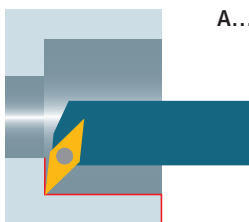

A... SVUC... (93°)

Inserts 177/201/249/259

All illustrations show right hand design. Left hand design is also available.

multidec®-ISO provides a well balanced range of tools for turning with rhombic 80° inserts and holders. Positive inserts with rounded cutting edges for roughing and sharp cutting edges for finishing are available.

These include a wide range of ground holders with hardened and nickel-plated surfaces for Swiss type automatic lathes with shank sizes from 8 to 20 mm and boring bars with diameters from 8 to 20 mm.

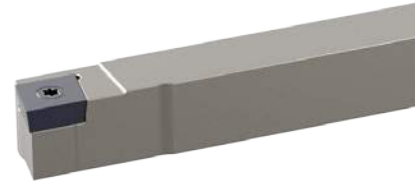

Advantages:

- High cutting volume with high feed rates
- Carbide and Cermet grades with chip breaker and coatings for all common materials
- Diamond range with CVD and PCD inserts for machining non-ferrous metals
- Cutting edge radius from 0.03 to 0.8 mm as standard
- Boring bars with steel- and carbide shank



“IC” tool holder with integrated cooling

Cost-efficient processing of modern materials increasingly requires accurate control of the coolant at the cutting edge. Conveying the coolant as close as possible to the cutting edge is often a difficult task in the machine rooms of Swiss type turning lathes.

The multidec®-IC program offers a wide range of holders with integrated cooling. Because of the high precision and pressure, it is possible to discharge the chip quickly and safely from the cutting edge and the workpiece, which protects the cutting edge of the insert. This means significantly longer tool life as well as very reliable serial production.

Advantages:

- All holders feature five possible connectors for the coolant supply
- Constant coolant discharge means low build-up at front near the holder
- With or without high pressure, the coolant medium always hits the cutting edge precisely

Inserts (carbide / cermet)



CCGT ... -PA3	178
CCGT ... -PA5	179
CCGT ... -PA7	180
CCXT ... PA9	181
CCGT ... -PF	182
CCGT ... FN -PF23	183
CCGT ... EN -PF23	184
CCMT ... -PF43	185
CCMT ... -PM	186
CCMT ... -PMF	187
CCMT ... -PM25	188
CCMT ... -PM55	189
CCET ... -U	190

Inserts (diamond)



CCGT ...	191
CCGT ... -UWS	192
CCGT ... -UWN	193
CCGT ... TOP -UWN	194

Holder (OD turning)



SCAC... U (90°)	195
SCDC... U (45°)	195
SCLC... U (95°), SCLC... U IC (95°)	196

Holder (ID turning)



A... SCFC... (90°)	198
A... SCLC... (95°)	199

Replacement and spare parts



Coolant system and accessories



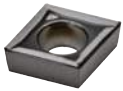
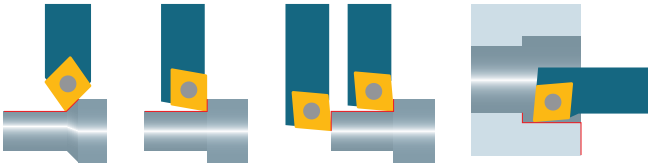

CCGT ... -PA3

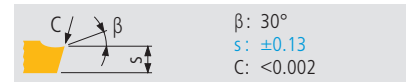
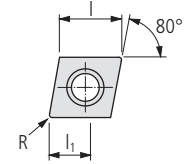

Order designation	Carbide												Cermet		Diamond		Dimensions			Holder			
	UHM 10	UHM 10 HX	UHM 10 TX+	UHM 10 MZ	UHM 20	UHM 20 HPX	UHM 20 TX+	UHM 20 MZ	UHM 30	UHM 30 HX	UHM 30 TX+	UHM 30 MZ	UHM 30 SX	UCM 10	UCM 10 HX	UCM 10 MZ	UCVD 08	UPCD 15	UPCD 20	I	R	l ₁	□ 195...
	-	-	●	●	○	●	●	●	○	●	●	○	●	●	●	-	-	-	-	-	-	-	-
	○	●	●	-	-	○	●	●	○	●	●	-	-	○	●	○	-	-	-	-	-	-	-
	○	○	-	-	-	○	○	-	-	-	-	-	-	-	-	-	●	●	●	-	-	-	-
	-	-	●	-	-	-	-	-	-	-	-	-	-	-	-	-	-	-	-	-	-	-	-

STANDARD-LINE

	CCGT 060202 FN -PA3 ...	CCGT 060204 FN -PA3 ...	CCGT 09T304 FN -PA3 ...	CCGT 09T308 FN -PA3 ...	I	R	l ₁	Holder
N	■ ■ ■	■ ■ ■	■ ■ ■	■ ■ ■	6.4	0.2	4	SC...06...
	■ ■ ■	■ ■ ■	■ ■ ■	■ ■ ■	6.4	0.4	4	SC...06...
	■ ■ ■	■ ■ ■	■ ■ ■	■ ■ ■	9.7	0.4	4	SC...09...
	■ ■ ■	■ ■ ■	■ ■ ■	■ ■ ■	9.7	0.8	4	SC...09...

Application range of chip breaker

Properties:

- polished rake
- ground clearance
- sharp cutting edge "F"
- micrograin carbide, heat and wear resistant

Optimal chip breaking

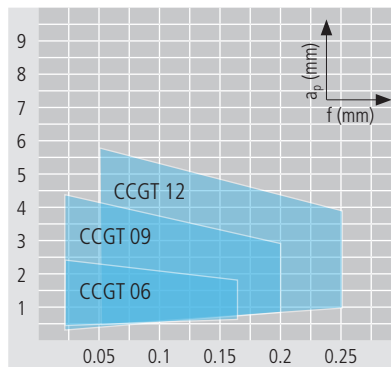

Application:

- micro finishing
- chip breaker for materials with difficult chip control
- stainless steel, alloyed steel, titanium, super alloy, aluminum and synthetics reinforced/composites

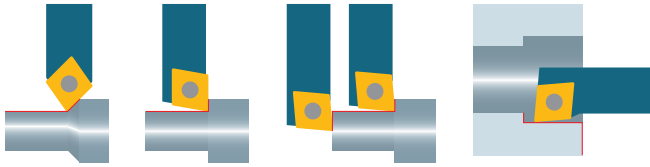

CCGT ... -PA5

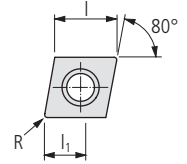

Order designation	Carbide														Cermet	Diamond		Dimensions			Holder			
	UHM 10	UHM 10 HX	UHM 10 TX+	UHM 10 MZ	UHM 20	UHM 20 HPX	UHM 20 TX+	UHM 20 MZ	UHM 30	UHM 30 HX	UHM 30 TX+	UHM 30 MZ	UHM 30 SX	UCM 10		UCM 10 HX	UCM 10 MZ	UCVD 08	UPCD 15	UPCD 20	I	R	I ₁	195...
	-	-	●	●	○	●	●	○	○	○	●	●	○	●	●	○	-	-	-	-	-	-	-	-
	○	○	●	●	○	●	●	○	○	○	●	●	○	●	●	○	-	-	-	-	-	-	-	-
	●	○	-	-	-	-	-	-	-	-	-	-	-	-	-	-	●	●	●	-	-	-	-	-
	-	-	●	●	-	-	-	-	-	-	-	-	-	-	-	-	-	-	-	-	-	-	-	-

STANDARD-LINE

N	Order designation	Material														Dimensions			Holder						
		UHM 10	UHM 10 HX	UHM 10 TX+	UHM 10 MZ	UHM 20	UHM 20 HPX	UHM 20 TX+	UHM 20 MZ	UHM 30	UHM 30 HX	UHM 30 TX+	UHM 30 MZ	UHM 30 SX	UCM 10	UCM 10 HX	UCM 10 MZ	UCVD 08	UPCD 15	UPCD 20	I	R	I ₁	195...	
	CCGT 060202 FN -PA5 ...	■	■	■																	6.4	0.2	4	SC...06...	
	CCGT 060204 FN -PA5 ...	■	■	■																		6.4	0.4	4	SC...06...
	CCGT 09T302 FN -PA5 ...	■	■	■																		9.7	0.2	6	SC...09...
	CCGT 09T304 FN -PA5 ...	■	■	■																		9.7	0.4	6	SC...09...
	CCGT 09T308 FN -PA5 ...	■	■	■																		9.7	0.8	6	SC...09...
	CCGT 120402 FN -PA5 ...	■	■	■																		12.9	0.2	8	SC...12...
	CCGT 120404 FN -PA5 ...	■	■	■																		12.9	0.4	8	SC...12...
	CCGT 120408 FN -PA5 ...	■	■	■																		12.9	0.8	8	SC...12...

Application range of chip breaker

Properties:

- polished rake
- ground clearance
- sharp cutting edge "F"
- submicrograin carbide, heat and wear resistant

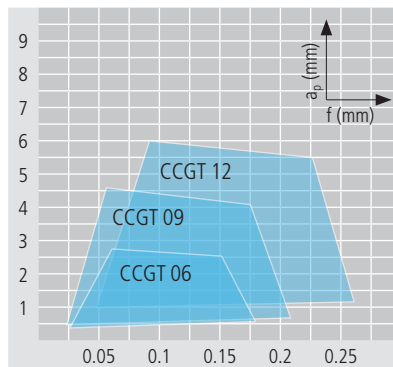

Optimal chip breaking

Application:

- finishing and micro finishing
- chip breaker for materials with difficult chip control
- stainless steel, alloyed steel, titanium, super alloy, aluminum and synthetics reinforced/ composites

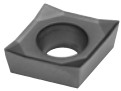
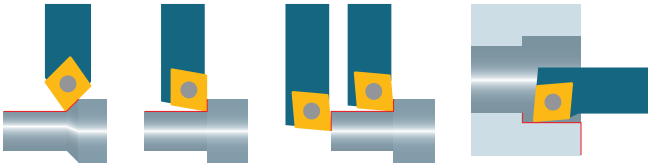

CCGT ... -PA7

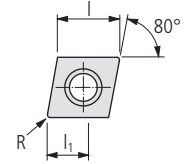

β : 27°
s: ±0.13
C: <0.002

Order designation	Carbide														Cermet		Diamond		Dimensions			Holder	
	UHM 10	UHM 10 HX	UHM 10 TX+	UHM 10 MZ	UHM 20	UHM 20 HPX	UHM 20 TX+	UHM 20 MZ	UHM 30	UHM 30 HX	UHM 30 TX+	UHM 30 MZ	UHM 30 SX	UCM 10	UCM 10 HX	UCM 10 MZ	UCVD 08	UPCD 15	UPCD 20	I	R	l ₁	□ 195...
	-	-	●	●	○	●	●	○	○	○	●	●	○	●	●	○	-	-	-				
	-	●	●	-	-	●	●	-	-	-	●	●	-	-	-	○	-	-	-				
	○	○	-	-	-	-	-	-	-	-	-	-	-	-	-	-	-	-	-				
	●	○	-	-	●	○	○	-	-	-	-	-	-	-	-	-	●	●	●				

STANDARD-LINE

N	Order designation	Material														I	R	l ₁	Holder						
		Al	St	Ti	Co	HT	HT	HT	HT	HT	HT	HT	HT	HT	HT					HT	HT	HT			
	CCGT 060202 FN -PA7 ...	■	■	■																	6.4	0.2	4	SC...06...	
	CCGT 060204 FN -PA7 ...	■	■	■																		6.4	0.4	4	SC...06...
	CCGT 09T3005 FN -PA7 ...	■	■	■																		9.7	0.05	6	SC...09...
	CCGT 09T301 FN -PA7 ...	■	■	■																		9.7	0.1	6	SC...09...
	CCGT 09T302 FN -PA7 ...	■	■	■																		9.7	0.2	6	SC...09...
	CCGT 09T304 FN -PA7 ...	■	■	■																		9.7	0.4	6	SC...09...
	CCGT 09T308 FN -PA7 ...	■	■	■																		9.7	0.8	6	SC...09...
	CCGT 120402 FN -PA7 ...	■	■	■																		12.9	0.2	8	SC...12...
	CCGT 120404 FN -PA7 ...	■	■	■																		12.9	0.4	8	SC...12...
	CCGT 120408 FN -PA7 ...	■	■	■																		12.9	0.8	8	SC...12...

Application range of chip breaker

Properties:

- ground clearance
- sharp cutting edge "F"
- micrograin carbide, heat and wear resistant

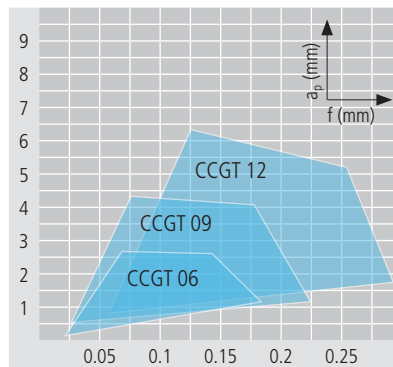

Optimal chip breaking

Application:

- micro finishing
- chip breaker for materials with good chip control
- stainless steel, alloyed steel, titanium, super alloy, aluminum and synthetics reinforced/composites

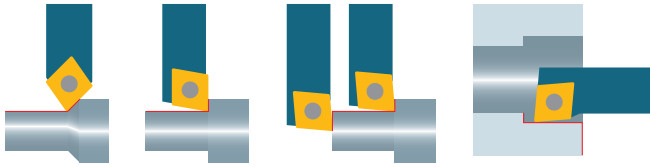

CCXT ... -PA9

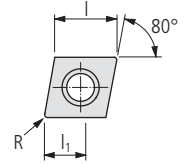

β : 25°
 s : ±0.1
 C : <0.01

Order designation	Carbide												Cermet		Diamond		Dimensions			Holder			
	UHM 10	UHM 10 HX	UHM 10 TX+	UHM 10 MZ	UHM 20	UHM 20 HPX	UHM 20 TX+	UHM 20 MZ	UHM 30	UHM 30 HX	UHM 30 TX+	UHM 30 MZ	UHM 30 SX	UCM 10	UCM 10 HX	UCM 10 MZ	UCVD 08	UPCD 15	UPCD 20	l	R	l ₁	195...
	-	-	●	●	○	●	●	○	○	○	○	○	○	○	○	○	○	○	○				
	○	●	●	-	○	●	●	○	○	○	○	○	○	○	○	○	○	○	○				
	○	○	-	-	-	-	-	-	-	-	-	-	-	-	-	-	-	-	-				
	-	-	●	-	-	○	○	-	-	-	-	-	-	-	-	-	-	-	-				

VALUE-LINE

	Order designation	UHM 10	UHM 10 HX	UHM 10 TX+	UHM 10 MZ	UHM 20	UHM 20 HPX	UHM 20 TX+	UHM 20 MZ	UHM 30	UHM 30 HX	UHM 30 TX+	UHM 30 MZ	UHM 30 SX	UCM 10	UCM 10 HX	UCM 10 MZ	UCVD 08	UPCD 15	UPCD 20	l	R	l ₁	Holder	
N	CCXT 060204 EN -PA9 ...	■	■	□																	6.4	0.4	4	SC...06...	
	CCXT 09T304 EN -PA9 ...	■	■	□																		9.7	0.4	6	SC...09...
	CCXT 09T308 EN -PA9 ...	■	■	□																		9.7	0.8	6	SC...09...

Application range of chip breaker

- Properties:**
- high precision sintered insert
 - rounded cutting edge "E"
 - micrograin carbide, heat and wear resistant
 - best performance-cost ratio

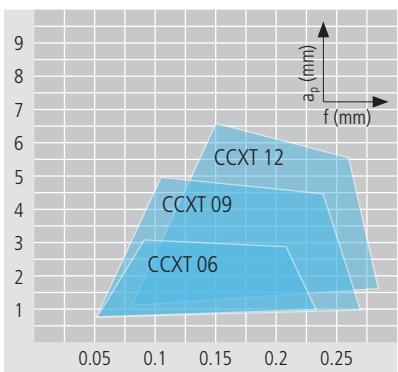

- Application:**
- finishing
 - chip breaker for soft materials with good chip control
 - alloyed steel, stainless steel, super alloy, titanium and aluminum

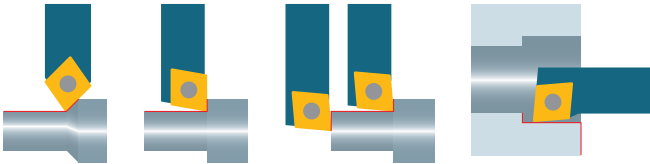

CCGT ... -PF

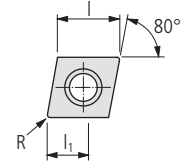

Order designation	Carbide														Cermet		Diamond		Dimensions			Holder	
	UHM 10	UHM 10 HX	UHM 10 TX+	UHM 10 MZ	UHM 20	UHM 20 HPX	UHM 20 TX+	UHM 20 MZ	UHM 30	UHM 30 HX	UHM 30 TX+	UHM 30 MZ	UHM 30 SX	UCM 10	UCM 10 HX	UCM 10 MZ	UCVD 08	UPCD 15	UPCD 20	I	R	l ₁	□ 195...
	-	-	●	●	○	●	●	●	○	●	●	○	○	○	○	○	-	-	-	I	R	l ₁	
	○	●	●	-	-	○	○	○	○	○	○	○	○	○	○	○	-	-	-	I	R	l ₁	
	○	○	-	-	-	-	-	-	-	-	-	-	-	-	-	-	●	●	●	I	R	l ₁	
	-	-	●	-	-	-	-	-	-	-	-	-	-	-	-	-	-	-	-	I	R	l ₁	

STANDARD-LINE

	CCGT 060202 EN -PF ...	CCGT 060204 EN -PF ...	CCGT 09T302 EN -PF ...	CCGT 09T304 EN -PF ...	CCGT 09T308 EN -PF ...	CCGT 120404 EN -PF ...	I	R	l ₁	Holder
N						■				SC...06...
							■	■	■	SC...06...
							■	■	■	SC...09...
							■	■	■	SC...09...
									■	SC...09...
							■	■		SC...12...

Application range of chip breaker

Properties:

- ground clearance
- little rounded cutting edge "E"
- carbide and cermet in different grades

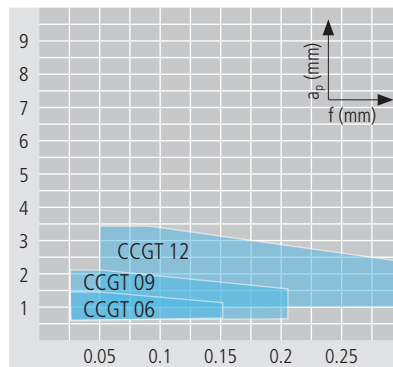

Optimal chip breaking

Application:

- finishing and micro finishing
- chip breaker for general application
- alloyed steel and stainless steel

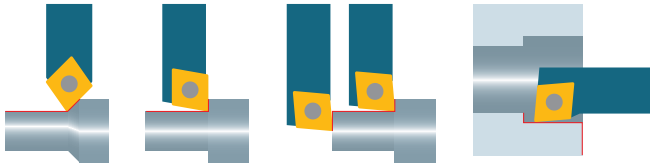

CCGT ... FN -PF23

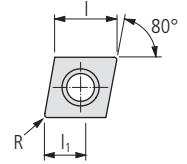

Order designation	Carbide														Cermet		Diamond		Dimensions			Holder	
	UHM 10	UHM 10 HX	UHM 10 TX+	UHM 10 MZ	UHM 20	UHM 20 HPX	UHM 20 TX+	UHM 20 MZ	UHM 30	UHM 30 HX	UHM 30 TX+	UHM 30 MZ	UHM 30 SX	UCM 10	UCM 10 HX	UCM 10 MZ	UCVD 08	UPCD 15	UPCD 20	l	R	l ₁	195...
	-	-	●	●	○	●	●	●	○	●	●	○	●	●	●	○	-	-	-				
	○	●	●	-	-	○	○	○	○	○	○	○	○	○	○	○	-	-	-				
	●	○	-	-	-	-	-	-	-	-	-	-	-	-	-	-	●	●	●				
	-	-	●	-	-	-	-	-	-	-	-	-	-	-	-	-	-	-	-				

STANDARD-LINE

	CCGT 0602005 FN -PF23 ...	CCGT 060201 FN -PF23 ...	CCGT 060202 FN -PF23 ...	CCGT 09T3005 FN -PF23 ...	CCGT 09T301 FN -PF23 ...	CCGT 09T302 FN -PF23 ...																		
N				■	■	■		■													6.4	0.05	2	SC...06...
				■	■	■		■													6.4	0.1	2	SC...06...
				■	■	■		■													6.4	0.2	2	SC...06...
				■	■	■		■													9.7	0.05	3	SC...09...
				■	■	■		■													9.7	0.1	3	SC...09...
				■	■	■		■													9.7	0.2	3	SC...09...

Application range of chip breaker

Properties:

- polished rake
- ground clearance
- sharp cutting edge "F"
- micrograin carbide

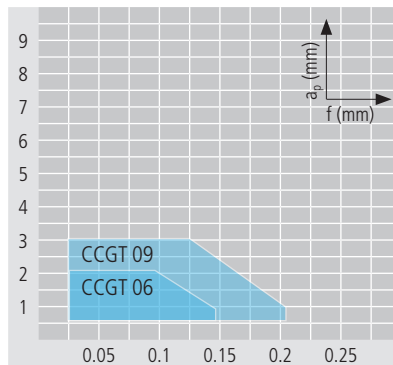

Optimal chip breaking

Application:

- micro finishing
- chip breaker for materials with difficult chip control
- alloyed steel and stainless steel

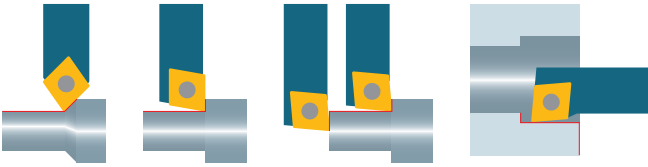

CCGT ... EN -PF23

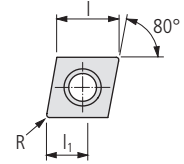

Order designation	Carbide														Cermet		Diamond		Dimensions			Holder	
	UHM 10	UHM 10 HX	UHM 10 TX+	UHM 10 MZ	UHM 20	UHM 20 HPX	UHM 20 TX+	UHM 20 MZ	UHM 30	UHM 30 HX	UHM 30 TX+	UHM 30 MZ	UHM 30 SX	UCM 10	UCM 10 HX	UCM 10 MZ	UCVD 08	UPCD 15	UPCD 20	I	R	l ₁	□ 195...
	-	-	●	●	○	●	●	●	●	○	●	●	○	●	●	●	-	-	-				
	○	●	●	-	-	○	●	●	○	○	●	●	-	○	○	-	-	-					
	○	○	-	-	-	○	-	-	-	-	-	-	-	-	-	-	●	●	●				
	-	-	●	-	-	-	○	-	-	-	-	-	-	-	-	-	-	-	-				

STANDARD-LINE

	CCGT 0602005 EN -PF23 ...	CCGT 060201 EN -PF23 ...	CCGT 060202 EN -PF23 ...	CCGT 09T3005 EN -PF23 ...	CCGT 09T301 EN -PF23 ...	CCGT 09T302 EN -PF23 ...																		
N				■	■	■															6.4	0.05	2	SC...06...
				■	■	■															6.4	0.1	2	SC...06...
				■	■	■															6.4	0.2	2	SC...06...
				■	■	■															9.7	0.05	3	SC...09...
				■	■	■															9.7	0.1	3	SC...09...
				■	■	■															9.7	0.2	3	SC...09...

Application range of chip breaker

Properties:

- polished rake
- ground clearance
- little rounded cutting edge "E"
- micrograin carbide

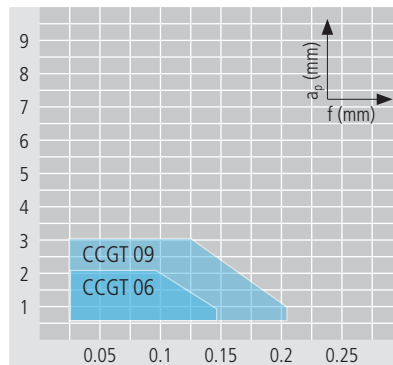

Optimal chip breaking

Application:

- finishing
- chip breaker for materials with difficult chip control
- alloyed steel and stainless steel

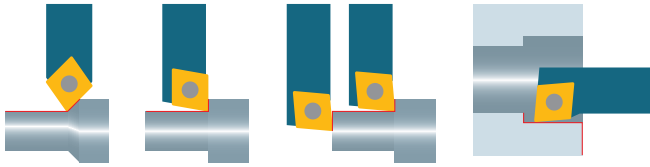

CCMT ... -PF43

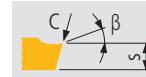
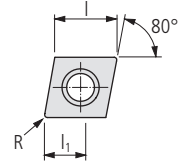

β : 12°
s: ±0.13
C: <0.02

Order designation	Carbide														Cermet	Diamond	Dimensions			Holder			
	UHM 10	UHM 10 HX	UHM 10 TX+	UHM 10 MZ	UHM 20	UHM 20 HPX	UHM 20 TX+	UHM 20 MZ	UHM 30	UHM 30 HX	UHM 30 TX+	UHM 30 MZ	UHM 30 SX	UCM 10	UCM 10 HX	UCM 10 MZ	UCVD08	UPCD 15	UPCD 20	l	R	l ₁	195...
	-	-	●	●	○	●	●	○	○	○	○	○	○	○	○	○	-	-	-				
	○	●	●	-	-	○	○	○	○	○	○	○	○	○	○	○	-	-	-				
	○	○	-	-	-	○	○	○	○	○	○	○	○	○	○	○	-	-	-				
	-	-	●	-	-	○	○	○	○	○	○	○	○	○	○	○	○	○	○				

VALUE-LINE

N	Order designation	Carbide														Cermet	Diamond	Dimensions			Holder				
		UHM 10	UHM 10 HX	UHM 10 TX+	UHM 10 MZ	UHM 20	UHM 20 HPX	UHM 20 TX+	UHM 20 MZ	UHM 30	UHM 30 HX	UHM 30 TX+	UHM 30 MZ	UHM 30 SX	UCM 10	UCM 10 HX	UCM 10 MZ	UCVD08	UPCD 15	UPCD 20	l	R	l ₁	195...	
	CCMT 060202 EN -PF43 ...									■											6.4	0.2	2.6	SC...06...	
	CCMT 060204 EN -PF43 ...									■												6.4	0.4	2.6	SC...06...
	CCMT 09T302 EN -PF43 ...									■												9.7	0.2	4	SC...09...
	CCMT 09T304 EN -PF43 ...										■											9.7	0.4	4	SC...09...
	CCMT 09T308 EN -PF43 ...											■										9.7	0.8	4	SC...09...

Application range of chip breaker

Properties:

- sintered insert based on ISO standard
- rounded cutting edge "E"
- micrograin carbide

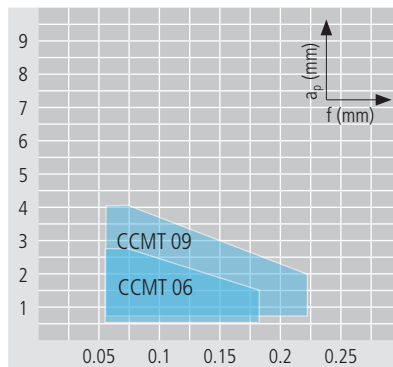

Optimal chip breaking

Application:

- roughing and finishing
- chip breaker for materials with difficult chip control
- alloyed steel and stainless steel

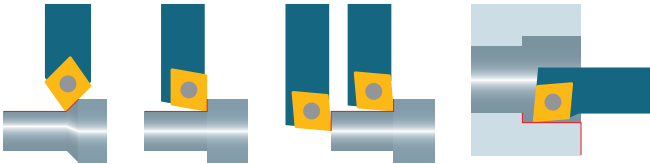

CCMT ... -PM

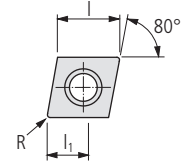

β : 8°
s: ±0.13
C: <0.02

Order designation	Carbide												Cermet		Diamond		Dimensions			Holder			
	UHM 10	UHM 10 HX	UHM 10 TX+	UHM 10 MZ	UHM 20	UHM 20 HPX	UHM 20 TX+	UHM 20 MZ	UHM 30	UHM 30 HX	UHM 30 TX+	UHM 30 MZ	UHM 30 SX	UCM 10	UCM 10 HX	UCM 10 MZ	UCVD 08	UPCD 15	UPCD 20	I	R	l ₁	□ 195...
	-	-	●	●	○	●	●	○	○	●	●	○	○	○	○	○	-	-	-				
	○	●	●	-	-	○	○	○	○	○	○	○	○	○	○	○	-	-	-				
	○	○	-	-	-	-	-	-	-	-	-	-	-	-	-	-	-	-	-				
	-	-	●	-	-	○	○	-	-	-	-	-	-	-	-	-	●	●	●				

VALUE-LINE

N	CCMT 060204 EN -PM ...			■			■			■											6.4	0.4	2	SC...06...	
	CCMT 060208 EN -PM ...			■								■										6.4	0.8	2	SC...06...
	CCMT 09T304 EN -PM ...			■									■									9.7	0.4	3.2	SC...09...
	CCMT 09T308 EN -PM ...			■										■								9.7	0.8	3.2	SC...09...
	CCMT 120404 EN -PM ...			■											■							12.9	0.4	4.8	SC...12...
	CCMT 120408 EN -PM ...			■												■						12.9	0.8	4.8	SC...12...

Application range of chip breaker

Properties:

- sintered insert based on ISO standard
- rounded cutting edge "E"
- micrograin carbide

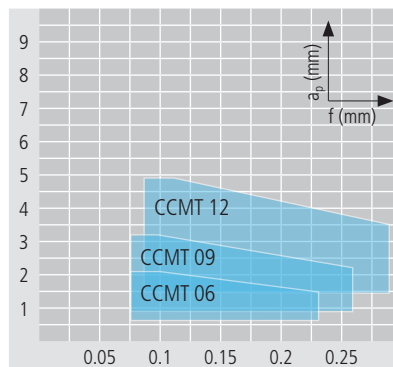

Optimal chip breaking

Application:

- roughing
- chip breaker for general application
- alloyed steel and stainless steel

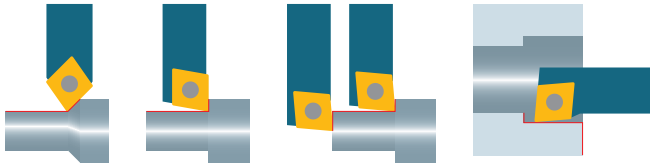

CCMT ... -PMF

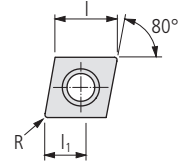

Order designation	Carbide												Cermet	Diamond		Dimensions			Holder					
	UHM 10	UHM 10 HX	UHM 10 TX+	UHM 10 MZ	UHM 20	UHM 20 HPX	UHM 20 TX+	UHM 20 MZ	UHM 30	UHM 30 HX	UHM 30 TX+	UHM 30 MZ		UHM 30 SX	UCM 10	UCM 10 HX	UCM 10 MZ	UCVD 08	UPCD 15	UPCD 20	l	R	l ₁	195...
	-	-	●	●	○	○	○	○	○	○	○	○	○	○	○	○	○	○	○	○				
	○	○	○	○	○	○	○	○	○	○	○	○	○	○	○	○	○	○	○	○				
	○	○	○	○	○	○	○	○	○	○	○	○	○	○	○	○	○	○	○	○				
	○	○	○	○	○	○	○	○	○	○	○	○	○	○	○	○	○	○	○	○				

VALUE-LINE

N	Order designation	UHM 10	UHM 10 HX	UHM 10 TX+	UHM 10 MZ	UHM 20	UHM 20 HPX	UHM 20 TX+	UHM 20 MZ	UHM 30	UHM 30 HX	UHM 30 TX+	UHM 30 MZ	UHM 30 SX	UCM 10	UCM 10 HX	UCM 10 MZ	UCVD 08	UPCD 15	UPCD 20	l	R	l ₁	Holder	
	CCMT 060204 EN -PMF ...														■						6.4	0.4	2	SC...06...	
	CCMT 09T304 EN -PMF ...														■							9.7	0.4	3.2	SC...09...
	CCMT 09T308 EN -PMF ...														■							9.7	0.8	3.2	SC...09...
	CCMT 120404 EN -PMF ...														■							12.9	0.4	4.8	SC...12...

Application range of chip breaker

- Properties:**
- sintered insert based on ISO standard
 - rounded cutting edge "E"
 - micrograin carbide

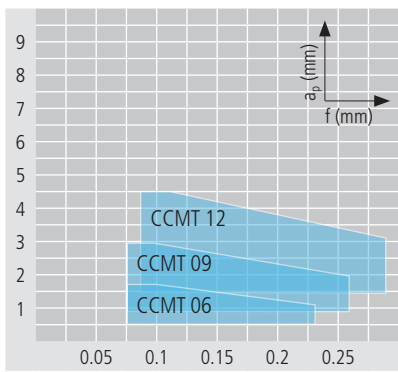

- Application:**
- roughing and finishing
 - chip breaker for general application
 - alloyed steel and stainless steel

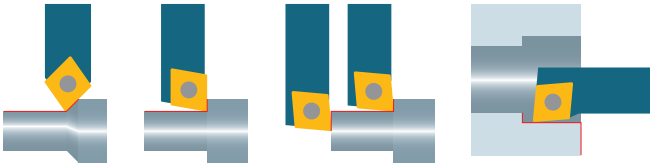

CCMT ... -PM25

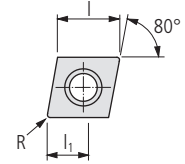

Order designation	Carbide												Cermet		Diamond		Dimensions			Holder			
	UHM 10	UHM 10 HX	UHM 10 TX+	UHM 10 MZ	UHM 20	UHM 20 HPX	UHM 20 TX+	UHM 20 MZ	UHM 30	UHM 30 HX	UHM 30 TX+	UHM 30 MZ	UHM 30 SX	UCM 10	UCM 10 HX	UCM 10 MZ	UCVD 08	UPCD 15	UPCD 20	I	R	l ₁	□ 195...
	-	-	●	●	○	●	●	●	○	●	●	○	●	●	●	○	-	-	-	6.4	0.4	2	SC...06...
	○	●	●	-	○	●	●	○	○	●	●	-	-	○	-	-	-	-	9.7	0.4	2.2	SC...09...	
	○	○	-	-	-	-	-	-	-	-	-	-	-	-	-	-	●	●	9.7	0.8	3.2	SC...09...	
	-	-	●	-	-	-	-	-	-	-	-	-	-	-	-	-	-	-					

VALUE-LINE



CCMT 060204 EN -PM25 ...						■															6.4	0.4	2	SC...06...
CCMT 09T304 EN -PM25 ...						■															9.7	0.4	2.2	SC...09...
CCMT 09T308 EN -PM25 ...						■															9.7	0.8	3.2	SC...09...

Application range of chip breaker

Properties:

- sintered insert based on ISO standard
- rounded cutting edge "E"
- micrograin carbide

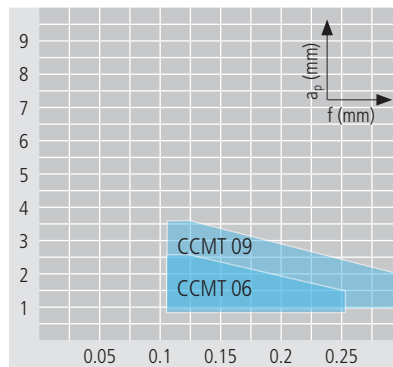

Optimal chip breaking

Application:

- roughing and finishing
- chip breaker for materials with difficult chip control
- stainless steel

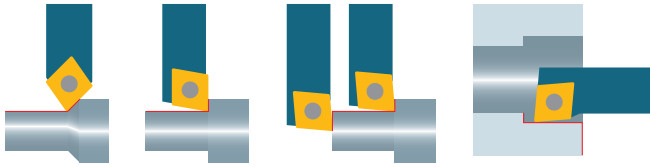

CCMT ... -PM55

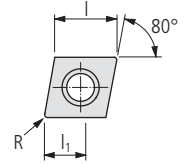

β : 16°
 s : ±0.13
 C : <0.02

Order designation	Carbide														Cermet	Diamond	Dimensions			Holder				
	UHM 10	UHM 10 HX	UHM 10 TX+	UHM 10 MZ	UHM 20	UHM 20 HPX	UHM 20 TX+	UHM 20 MZ	UHM 30	UHM 30 HX	UHM 30 TX+	UHM 30 MZ	UHM 30 SX	UCM 10			UCM 10 HX	UCM 10 MZ	UCVD 08		UPCD 15	UPCD 20	l	R
	-	-	●	●	○	●	●	○	○	○	○	○	○	○	○	○	○	○	○	○				
	○	●	●	-	○	○	○	○	○	○	○	○	○	○	○	○	○	○	○	○				
	○	○	-	-	-	-	-	-	-	-	-	-	-	-	-	-	-	-	-	-				
	-	-	●	-	-	○	○	○	○	○	○	○	○	○	○	○	○	○	○	○				

VALUE-LINE

	CCMT 060204 EN -PM55 ...	CCMT 09T304 EN -PM55 ...	CCMT 09T308 EN -PM55 ...	CCMT120404 EN -PM55 ...	CCMT120408 EN -PM55 ...	6.4	0.4	2.6	SC...06...
N	■	■	■	■	■	9.7	0.4	3	SC...09...
						9.7	0.8	4	SC...09...
						12.9	0.4	4	SC...12...
						12.9	0.8	4.8	SC...12...

Application range of chip breaker

- Properties:**
- sintered insert based on ISO standard
 - rounded cutting edge "E"
 - micrograin carbide

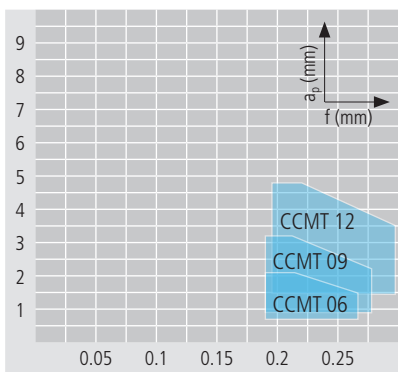

- Application:**
- roughing
 - chip breaker for general application
 - stainless steel

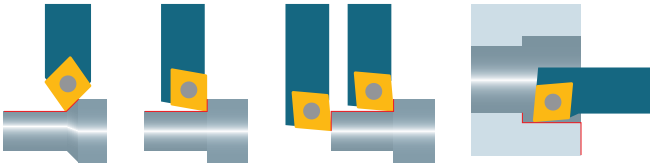

CCET ... -U

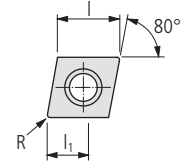

Order designation	Carbide														Cermet		Diamond		Dimensions			Holder	
	UHM 10	UHM 10 HX	UHM 10 TX+	UHM 10 MZ	UHM 20	UHM 20 HPX	UHM 20 TX+	UHM 20 MZ	UHM 30	UHM 30 HX	UHM 30 TX+	UHM 30 MZ	UHM 30 SX	UCM 10	UCM 10 HX	UCM 10 MZ	UCVD 08	UPCD 15	UPCD 20	I	R	l ₁	□ 195...
	-	-	●	●	○	●	●	●	○	●	●	○	○	○	○	○	-	-	-				
	○	●	●	-	-	○	○	○	○	○	○	○	○	○	○	○	-	-	-				
	○	○	-	-	-	○	○	○	○	○	○	○	○	○	○	○	-	-	-				
	-	-	●	-	-	-	-	-	-	-	-	-	-	-	-	-	●	●	●				

PREMIUM-LINE

	CCET 0602003 FR -U ...	CCET 060201 FR -U ...	CCET 060202 FR -U ...	CCET 09T3003 FR -U ...	CCET 09T301 FR -U ...	CCET 09T302 FR -U ...	I	R	l ₁	Holder
R	■ ■ □	■ ■ □	■ ■ □	■ ■ □	■ ■ □	■ ■ □	6.4	0.03	2.5	SC...06...
	■ ■ □	■ ■ □	■ ■ □	■ ■ □	■ ■ □	■ ■ □	6.4	0.1	2.5	SC...06...
	■ ■ □	■ ■ □	■ ■ □	■ ■ □	■ ■ □	■ ■ □	6.4	0.2	2.5	SC...06...
	■ ■ □	■ ■ □	■ ■ □	■ ■ □	■ ■ □	■ ■ □	9.7	0.03	4	SC...09...
	■ ■ □	■ ■ □	■ ■ □	■ ■ □	■ ■ □	■ ■ □	9.7	0.1	4	SC...09...
	■ ■ □	■ ■ □	■ ■ □	■ ■ □	■ ■ □	■ ■ □	9.7	0.2	4	SC...09...

Application range of chip breaker

Properties:

- ground rake and clearance
- sharp cutting edge "F"
- submicrograin carbide, heat and wear resistant and cermet

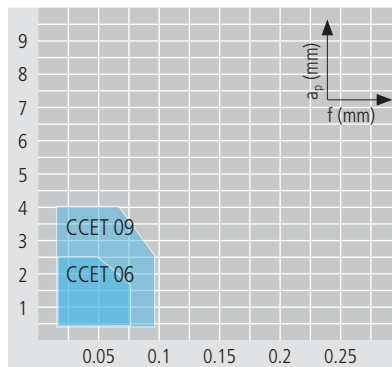

Optimal chip breaking

Application:

- micro finishing
- chip breaker for materials with difficult chip control
- alloyed steel and stainless steel

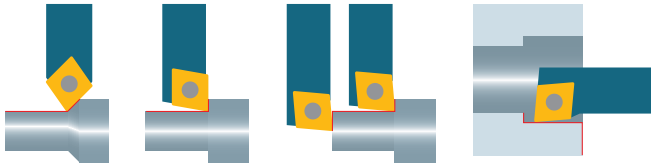

CCGT ...

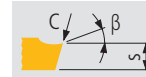
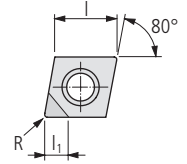

β: 7°
s: ±0.13
C: <0.002

Order designation	Carbide														Cermet		Diamond		Dimensions			Holder	
	-	-	●	●	○	○	●	●	○	○	●	●	○	○	-	-	-	-	I	R	l ₁	195...	
	UHM 10	UHM 10 HX	UHM 10 TX+	UHM 10 MZ	UHM 20	UHM 20 HPX	UHM 20 TX+	UHM 20 MZ	UHM 30	UHM 30 HX	UHM 30 TX+	UHM 30 MZ	UHM 30 SX	UCM 10	UCM 10 HX	UCM 10 MZ	UCVD 08	UPCD 15	UPCD 20				

STANDARD-LINE

N	Order designation	Carbide														Cermet		Diamond		Dimensions			Holder
		-	-	●	●	○	○	●	●	○	○	●	●	○	○	-	-	-	-	I	R	l ₁	195...
	CCGT 060201 FN ...															■	■			6.4	0.1	3.5	SC...06...
	CCGT 060202 FN ...															■	■			6.4	0.2	3.5	SC...06...
	CCGT 060204 FN ...															■	■			6.4	0.4	3.5	SC...06...
	CCGT 09T302 FN ...															■	■			9.7	0.2	4.5	SC...09...
	CCGT 09T304 FN ...															■	■			9.7	0.4	4.3	SC...09...

Application range of chip breaker

- Properties:**
- sharp cutting edge "F"
 - less cutting force
 - positive cut

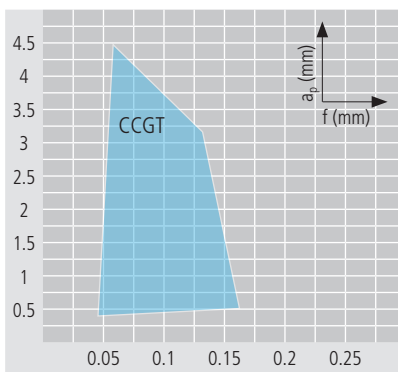

Optimal chip breaking

- Application:**
- finishing and micro finishing for unstable or thin-walled parts
 - chip breaker for general application will generate continues chip
 - aluminum, brass, copper, bronze, platinum, gold, synthetics and synthetics reinforced/composites
 - Ideal for smallest tolerance and medium surface quality

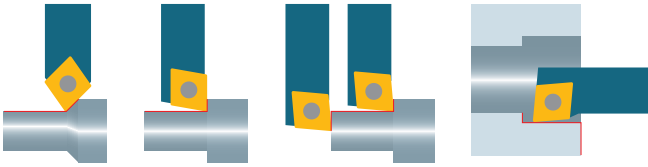

CCGT ... -UWS

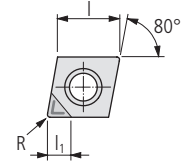

β : 15–20°
s: ±0.13
C: <0.002

Order designation	Carbide														Cermet		Diamond		Dimensions			Holder	
	UHM 10	UHM 10 HX	UHM 10 TX+	UHM 10 MZ	UHM 20	UHM 20 HPX	UHM 20 TX+	UHM 20 MZ	UHM 30	UHM 30 HX	UHM 30 TX+	UHM 30 MZ	UHM 30 SX	UCM 10	UCM 10 HX	UCM 10 MZ	UCVD 08	UPCD 15	UPCD 20	l	R	l ₁	□ 195...
	-	-	●	●	○	●	●	○	○	●	●	○	○	○	○	○	-	-	-	6.4	0.2	3	SC...06...
	○	●	●	-	-	○	○	○	○	○	○	○	○	○	○	○	-	-	-	6.4	0.4	3	SC...06...
	○	○	-	-	-	-	-	-	-	-	-	-	-	-	-	-	-	-	9.7	0.2	3	SC...09...	
	-	-	●	-	-	○	○	-	-	-	-	-	-	-	-	-	●	●	-	9.7	0.4	3	SC...09...

STANDARD-LINE

	CCGT 060202 FN -UWS ...	CCGT 060204 FN -UWS ...	CCGT 09T302 FN -UWS ...	CCGT 09T304 FN -UWS ...
N				

Application range of chip breaker

Properties:

- sharp cutting edge "F"
- almost any cutting force
- high positive narrow chip breaker made by laser

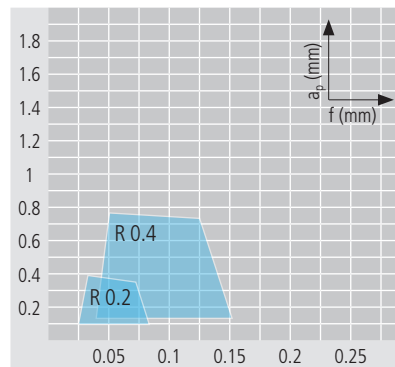

Optimal chip breaking

Application:

- micro finishing for unstable or thin-walled parts
- chip breaker for materials with difficult chip control
- synthetics reinforced/composites, aluminum, platinum, gold and synthetics
- ideal for smallest tolerance and medium surface quality

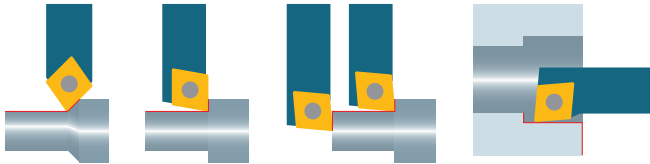

CCGT ... -UWN

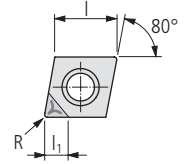

Order designation	Carbide												Cermet	Diamond		Dimensions			Holder					
	UHM 10	UHM 10 HX	UHM 10 TX+	UHM 10 MZ	UHM 20	UHM 20 HPX	UHM 20 TX+	UHM 20 MZ	UHM 30	UHM 30 HX	UHM 30 TX+	UHM 30 MZ		UHM 30 SX	UCM 10	UCM 10 HX	UCM 10 MZ	UCVD 08	UPCD 15	UPCD 20	I	R	I ₁	195...
	-	-	•	•	•	•	•	•	•	•	•	•	•	•	•	•	•	•	•	•				
	○	○	○	○	○	○	○	○	○	○	○	○	○	○	○	○	○	○	○	○				
	-	○	-	-	-	-	-	-	-	-	-	-	-	-	-	-	-	-	-	-				

STANDARD-LINE

N	Order designation	Carbide												Cermet	Diamond		Dimensions			Holder					
		UHM 10	UHM 10 HX	UHM 10 TX+	UHM 10 MZ	UHM 20	UHM 20 HPX	UHM 20 TX+	UHM 20 MZ	UHM 30	UHM 30 HX	UHM 30 TX+	UHM 30 MZ		UHM 30 SX	UCM 10	UCM 10 HX	UCM 10 MZ	UCVD 08	UPCD 15	UPCD 20	I	R	I ₁	195...
	CCGT 060202 FN -UWN ...																■	■	■	■	6.4	0.2	3	SC...06...	
	CCGT 060204 FN -UWN ...																	■	■	■	■	6.4	0.4	3	SC...06...
	CCGT 09T302 FN -UWN ...																	■	■	■	■	9.7	0.2	3	SC...09...
	CCGT 09T304 FN -UWN ...																	■	■	■	■	9.7	0.4	3	SC...09...

Application range of chip breaker

Properties:

- sharp cutting edge "F"
- higher cutting force
- high positive wide chip breaker made by laser

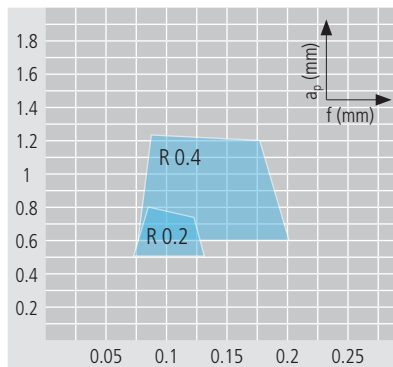

Optimal chip breaking

Application:

- finishing for stable or solid parts
- chip breaker for materials with difficult chip control
- synthetics reinforced/composites, aluminum, platinum, gold and synthetics
- ideal for smallest tolerance and best surface quality

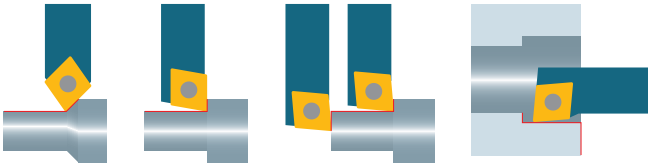

CCGT ... TOP* -UWN

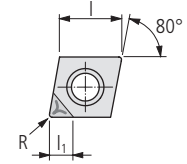

β : 15–20°
s: ±0.13
C: <0.005

Order designation	Carbide													Cermet		Diamond			Dimensions			Holder	
	UHM 10	UHM 10 HX	UHM 10 TX+	UHM 10 MZ	UHM 20	UHM 20 HPX	UHM 20 TX+	UHM 20 MZ	UHM 30	UHM 30 HX	UHM 30 TX+	UHM 30 MZ	UHM 30 SX	UCM 10	UCM 10 HX	UCM 10 MZ	UCVD 08	UPCD 15	UPCD 20	I	R	l ₁	195...
	-	-	●	●	●	●	●	●	●	●	●	●	●	●	●	●	-	-	-				
	○	○	○	-	○	○	○	○	○	○	○	○	○	○	○	○	-	-	-				
	○	○	-	-	○	○	○	○	○	○	○	○	○	○	○	○	○	○	○				
	-	-	●	-	-	-	-	-	-	-	-	-	-	-	-	-	●	●	●				

STANDARD-LINE

N	Description	UHM 10	UHM 10 HX	UHM 10 TX+	UHM 10 MZ	UHM 20	UHM 20 HPX	UHM 20 TX+	UHM 20 MZ	UHM 30	UHM 30 HX	UHM 30 TX+	UHM 30 MZ	UHM 30 SX	UCM 10	UCM 10 HX	UCM 10 MZ	UCVD 08	UPCD 15	UPCD 20	I	R	l ₁	Holder		
	CCGT 060202 FN TOP -UWN ...																	■	■	■	6.4	0.2	3		SC...06...	
	CCGT 060204 FN TOP -UWN ...																		■	■	■	6.4	0.4	3		SC...06...
	CCGT 09T302 FN TOP -UWN ...																		■	■	■	9.7	0.2	3		SC...09...
	CCGT 09T304 FN TOP -UWN ...																		■	■	■	9.7	0.4	3		SC...09...

* Description TOP 13

Application range of chip breaker

- Properties:**
- sharp cutting edge "F"
 - higher cutting force
 - high positive wide chip breaker made by laser
 - TOP system, for a better surface finish

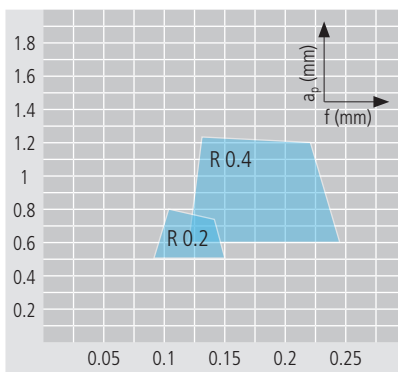

- Application:**
- finishing for stable or solid parts
 - chip breaker for materials with difficult chip control
 - synthetics reinforced/composites, aluminum, platinum, gold and synthetics
 - ideal for smallest tolerance and best surface quality

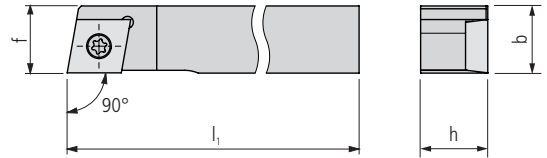
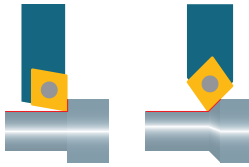

SCAC... U (90°)

Order designation		Dimensions							Inserts
L	R	b	h	l ₁		f			□ 178...

STANDARD-LINE

SCACL 0808 K06 U	■	SCACR 0808 K06 U	■	8	8	125		8		CC..0602..
SCACL 1010 M06 U	■	SCACR 1010 M06 U	■	10	10	150		10		CC..0602..
SCACL 1212 M09 U	■	SCACR 1212 M09 U	■	12	12	150		12		CC..09T3..
SCACL 1616 H09 U	■	SCACR 1616 H09 U	■	16	16	100		16		CC..09T3..
SCACL 2020 K12 U	■	SCACR 2020 K12 U	■	20	20	125		20		CC..1204..

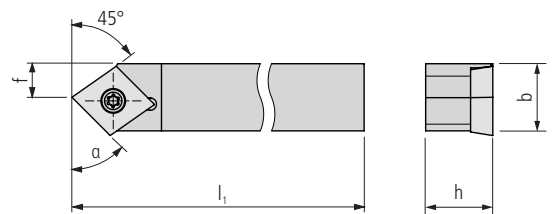

SCDC... U (45°)

Order designation		Dimensions							Inserts
L	R	b	h	l ₁		f		a	□ 178...

STANDARD-LINE

SCDCL 0808 K06 U	■			8	8	125		4	55°	CC..0602..
SCDCL 1010 M06 U	■			10	10	150		5	55°	CC..0602..
SCDCL 1212 M09 U	■			12	12	150		6	55°	CC..09T3..

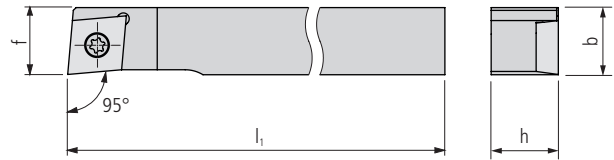
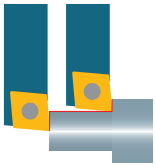

SCLC... U (95°)

Order designation		Dimensions							Inserts
L	R	h	b	l ₁		f		□ 178...	

STANDARD-LINE

SCLCL 0808 F06 U	■	SCLCR 0808 F06 U	■	8	8	80		7.95			CC..0602..
SCLCL 0808 H06 U	■	SCLCR 0808 H06 U	■	8	8	100		7.95			CC..0602..
SCLCL 1010 F06 U	■	SCLCR 1010 F06 U	■	10	10	80		9.95			CC..0602..
SCLCL 1010 H06 U	■	SCLCR 1010 H06 U	■	10	10	100		9.95			CC..0602..
SCLCL 1212 H09 U	■	SCLCR 1212 H09 U	■	12	12	100		11.95			CC..09T3..
SCLCL 1616 K09 U	■	SCLCR 1616 K09 U	■	16	16	125		15.95			CC..09T3..

SCLC... U (95°) INCH

Order designation		Dimensions							Inserts
L	R	h	b	l ₁		f		□ 178...	

STANDARD-LINE

SCLCL 3/8" H06 U	■	SCLCR 3/8" H06 U	■	9.525	9.525	100		9.475			CC..0602..
SCLCL 1/2" H09 U	■	SCLCR 1/2" H09 U	■	12.7	12.7	100		12.65			CC..09T3..
SCLCL 5/8" K09 U	■	SCLCR 5/8" K09 U	■	15.875	15.875	125		15.825			CC..09T3..

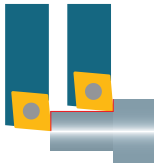

With internal cooling

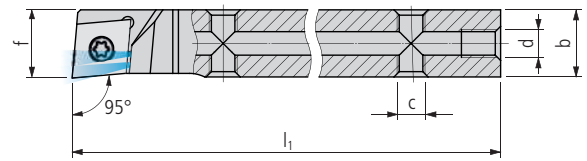
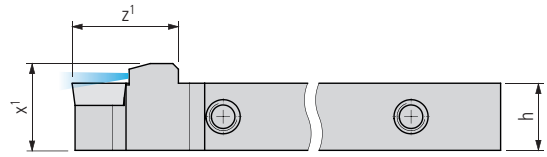

SCLC... U IC (95°)

Order designation		Dimensions									Inserts
L	R	h	b	l ₁	z ¹	x ¹	c	d	f	□ 178...	

PREMIUM-LINE

SCLCL 0808 H06 U IC	■	SCLCR 0808 H06 U IC	■	8	8	100	16	11.5	M5	M5	7.95	CC..0602..
SCLCL 1010 H06 U IC	■	SCLCR 1010 H06 U IC	■	10	10	100	16	13.5	M5	M5	9.95	CC..0602..
SCLCL 1212 H09 U IC	■	SCLCR 1212 H09 U IC	■	12	12	100	19	15.5	M5	M5	11.95	CC..09T3..
SCLCL 1616 K09 U IC	■	SCLCR 1616 K09 U IC	■	16	16	125	19	19.5	M5	G½"	15.95	CC..09T3..

SCLC... U IC (95°) INCH

Order designation		Dimensions									Inserts
L	R	h	b	l ₁	z ¹	x ¹	c	d	f	□ 178...	

PREMIUM-LINE

SCLCL 3/8" H06 U IC	■	SCLCR 3/8" H06 U IC	■	9.525	9.525	100	16	13	M5	M5	9.475	CC..0602...
SCLCL 1/2" H09 U IC	■	SCLCR 1/2" H09 U IC	■	12.7	12.7	100	19	16.2	M5	M5	12.65	CC..09T3..
SCLCL 5/8" K09 U IC	■	SCLCR 5/8" K09 U IC	■	15.875	15.875	125	19	19.4	M5	G½"	15.825	CC..09T3..

Scope of delivery: Holder without coolant connector

Coolant system □ 619...

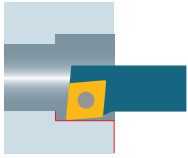

198

UTILIS **multidec**®
swiss type tools

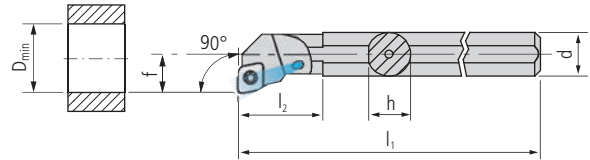

A... SCFC... (90°)

Order designation		Dimensions							Inserts
L	R	d	h	l ₁	l ₂	f	D _{min}	□178...	

STANDARD-LINE

A08F SCFCL 06	■	A08F SCFCR 06	■	8	7.6	80	17	5	11	CC..0602..
A10H SCFCL 06	■	A10H SCFCR 06	■	10	9.5	100	19	7	13	CC..0602..
A12K SCFCL 06	■	A12K SCFCR 06	■	12	11.5	125	22	9	16	CC..0602..

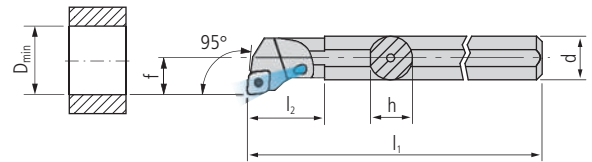
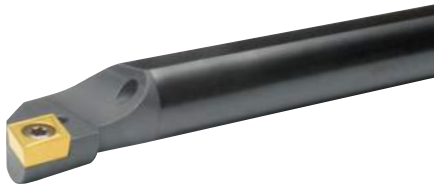

A... SCLC... (95°)

Order designation		Dimensions							Inserts
L	R	d	h	l ₁	l ₂	f	D _{min}	□ 178...	

STANDARD-LINE

A08F SCLCL 06	■	A08F SCLCR 06	■	8	7.6	80	17	5	11		CC..0602..
A10H SCLCL 06	■	A10H SCLCR 06	■	10	9.5	100	19	7	13		CC..0602..
A12K SCLCL 06	■	A12K SCLCR 06	■	12	11.5	125	22	9	16		CC..0602..
A16M SCLCL 09	■	A16M SCLCR 09	■	16	15	150	29	11	20		CC..09T3..
A20Q SCLCL 09	■	A20Q SCLCR 09	■	20	18.5	180	32	13	25		CC..09T3..

Replacement and spare parts

For holders (SC...) OD turning

Illustration	Description	Dimensions	Order designation	Holder
	TORX screw	M2.5 × 6 T08	MSP 25060 T08	■ SC... 06
		M3.5 × 11 T15	MSP 35110 T15	■ SC... 09
		M4.5 × 12 T15	MSP 45120 T15	■ SC... 12

For holders (... SC...) ID turning

Illustration	Description	Dimensions	Order designation	Holder
	TORX screw	M2.5 × 5 T08	MSP 25050 T08	■ A... SC... 06
		M3.5 × 7.2 T15	MSP 35072 T15	■ A16M SC...09
		M3.5 × 8.6 T15	MSP 35086 T15	■ A20Q SC... 09

TORX screwdriver □ 651...

Legend □ 8...

multidec®-ISO provides a well balanced range of tools for turning with rhombic 55° inserts and holders. Positive inserts with rounded cutting edges for roughing and sharp cutting edges for finishing are available.

These include a wide range of ground holders with hardened and nickel-plated surfaces for Swiss type automatic lathes with shank sizes from 8 to 20 mm and boring bars with diameters from 10 to 20 mm.

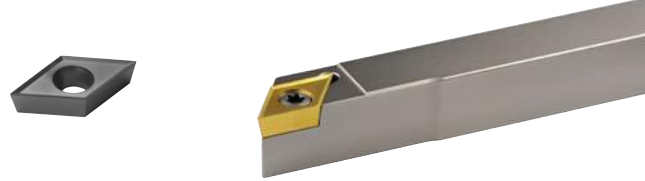

Advantages:

- Carbide and Cermet grades with chip breaker and coatings for all common materials
- Diamond range with CVD and PCD inserts for machining non-ferrous metals
- Cutting edge radius from 0.03 to 0.8 mm as standard
- Boring bars with steel- and carbide shanks



"IC" tool holder with integrated cooling

Cost-efficient processing of modern materials increasingly requires accurate control of the coolant at the cutting edge. Conveying the coolant as close as possible to the cutting edge is often a difficult task in the machine rooms of Swiss type turning lathes.

The multidec®-IC program offers a wide range of holders with integrated cooling. Because of the high precision and pressure, it is possible to discharge the chip quickly and safely from the cutting edge and the workpiece, which protects the cutting edge of the insert. This means significantly longer tool life as well as very reliable serial production.

Advantages:

- All holders feature five possible connectors for the coolant supply
- Constant coolant discharge means low build-up at front near the holder
- With or without high pressure, the coolant medium always hits the cutting edge precisely



"TWIN" holder with and without integrated coolant supply

The "TWIN" range allows you to work with two inserts on the same holder. Different combinations are possible, and provide the user with a high degree of flexibility. Holders are available with shank cross-sections of 8 to 20 mm, with and without internal cooling.

Advantages:

- Twice the number of tools on the machine
- Two different turning operations are possible with a single tool holder
- All holders with an integrated coolant supply have five connecting options



"FC" holder with quick cutting edge change system (fast change)

The cutting edge can be changed without unclamping the holder using the "FC" holder. The indexable insert is mounted using a specially developed knee lever which is operated using a clamping screw on the rear of the holder.

Advantages:

- Quick indexable insert change directly in the machine
- Holder with and without integrated coolant supply

Inserts (carbide / cermet)

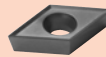

DCGT ... FN -A3, DCGT ... EN -A3	202
DCGT ... -PA3	204
DCGT ... -PA5	205
DCGT ... -TOP5	206
DCGT ... -PA7	207
DCXT ... -PA9	208
DCGT ... FN -PF, DCGT ... EN -PF	209
DCMT ... -PF	211
DCET ... -PF05	212
DCGT ... FN -PF23, DCGT ... EN -PF23	213
DCGT ... FN -PF33, DCGT ... EN -PF33	215
DCMT ... -PF43	217
DCMT ... -PM, DCMT ... -PMF	218
DCMT ... -PM25	220
DCMT ... -PM55	221
DCET ... -U	222

Inserts (diamond)

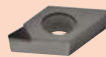

DCGT ...	223
DCGT ... -UWS	224
DCGT ... -UWN	225
DCGW ...	226

HOLDERS (OD turning)



SDAC... U (90°)	227
SDHC... U (107.5°), SDHC... U IC(107.5°)	228
SDJC... U (93°), SDJC... U IC (93°)	230
SDJC... U FC (93°), SDJC... U FC IC (93°)	232
SDNC... U (62.5°), SDNC... U IC (62.5°)	234
SDNCN ... U (62.5°), SDNCN ... U IC (62.5°)	236
SDJC. (93°)/1600... TWIN, SDJC. (93°)/1600... IC TWIN	238

HOLDERS (ID turning)



SDHC... (107.5°), SDHC... IC (107.5°)	240
A... SDOC... (95°), A... SDQC... (107.5°)	242
SDUC... (93°), SDUC... IC (93°)	244
A... SDUC... (93°)	246

Replacement and spare parts



	247
--	-----

Coolant system and accessories



	619
--	-----

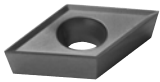
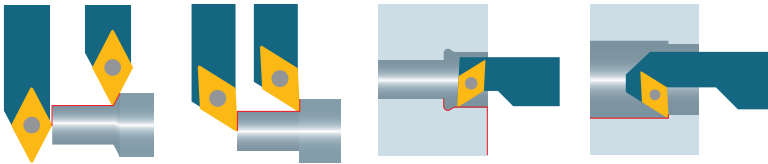

DCGT ... FN -A3

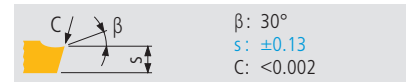
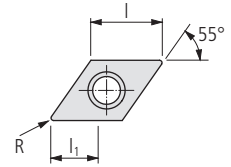

Order designation	Carbide												Cermet			Diamond			Dimensions			Holder	
	UHM 10	UHM 10 HX	UHM 10 TX+	UHM 10 MZ	UHM 20	UHM 20 HPX	UHM 20 TX+	UHM 20 MZ	UHM 30	UHM 30 HX	UHM 30 TX+	UHM 30 MZ	UHM 30 SX	UCM 10	UCM 10 HX	UCM 10 MZ	UCVD 08	UPCD 15	UPCD 20	L	R	I ₁	□ 227...
	-	-	●	●	○	●	●	●	○	●	●	○	○	○	○	○	-	-	-				
	○	●	●	-	-	○	○	○	○	○	○	○	○	○	○	○	-	-	-				
	○	○	-	-	-	-	-	-	-	-	-	-	-	-	-	-	-	-	-				
	-	-	●	-	-	○	○	-	-	-	-	-	-	-	-	-	●	●	●				

STANDARD-LINE

	DCGT 0702006 FN -A3 ...	DCGT 0702015 FN -A3 ...	DCGT 0702035 FN -A3 ...	DCGT 11T3008 FN -A3 ...	DCGT 11T3015 FN -A3 ...	DCGT 11T3035 FN -A3 ...																		
N	■	■	■	■	■	■															7.75	0.06	4.1	SD...07...
	■	■	■	■	■	■															7.75	0.15	4.1	SD...07...
	■	■	■	■	■	■															7.75	0.35	4.1	SD...07...
	■	■	■	■	■	■															11.6	0.08	7.2	SD...11...
	■	■	■	■	■	■															11.6	0.15	7.2	SD...11...
	■	■	■	■	■	■															11.6	0.35	7.2	SD...11...

Application range of chip breaker

Properties:

- polished rake
- ground clearance
- sharp cutting edge "F"
- submicrograin carbide, heat and wear resistant

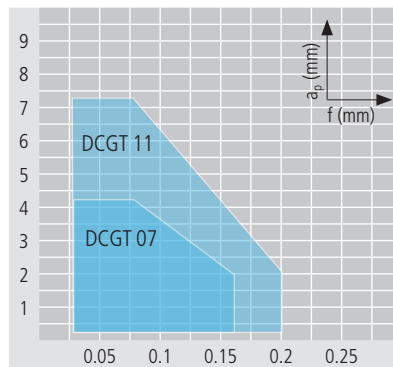

Optimal chip breaking

Application:

- micro finishing
- chip breaker for general application
- stainless steel, alloyed steel, titanium, super alloy, aluminum and synthetics reinforced/composites

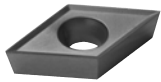
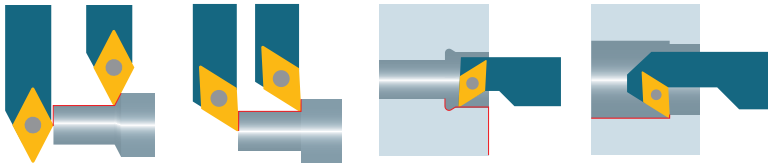

DCGT ... EN -A3

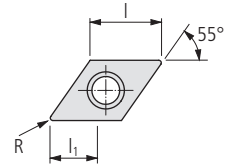

Order designation	Carbide												Cermet	Diamond		Dimensions			Holder					
	UHM 10	UHM 10 HX	UHM 10 TX+	UHM 10 MZ	UHM 20	UHM 20 HPX	UHM 20 TX+	UHM 20 MZ	UHM 30	UHM 30 HX	UHM 30 TX+	UHM 30 MZ		UHM 30 SX	UCM 10	UCM 10 HX	UCM 10 MZ	UCVD 08	UPCD 15	UPCD 20	I	R	l ₁	□ 227...
	-	-	•	•	•	•	•	•	•	•	•	•	•	•	•	•	-	-	-	-	-	-	-	-
	○	•	•	-	-	○	•	•	•	•	•	•	•	•	•	•	-	-	-	-	-	-	-	-
	-	○	-	-	-	-	-	-	-	-	-	-	-	-	-	-	•	•	•	•	-	-	-	-
	-	-	•	-	-	-	-	-	-	-	-	-	-	-	-	-	-	-	-	-	-	-	-	-

STANDARD-LINE

N	Order designation	Carbide												Cermet	Diamond		Dimensions			Holder									
		UHM 10	UHM 10 HX	UHM 10 TX+	UHM 10 MZ	UHM 20	UHM 20 HPX	UHM 20 TX+	UHM 20 MZ	UHM 30	UHM 30 HX	UHM 30 TX+	UHM 30 MZ		UHM 30 SX	UCM 10	UCM 10 HX	UCM 10 MZ	UCVD 08	UPCD 15	UPCD 20	I	R	l ₁	SD...				
	DCGT 0702006 EN -A3 ...					■	■	■																	7.75	0.06	4.1	SD...07...	
	DCGT 0702015 EN -A3 ...					■	■	■																		7.75	0.15	4.1	SD...07...
	DCGT 0702035 EN -A3 ...					■	■	■																		7.75	0.35	4.1	SD...07...
	DCGT 11T3008 EN -A3 ...					■	■	■																		11.6	0.08	7.2	SD...11...
	DCGT 11T3015 EN -A3 ...					■	■	■																		11.6	0.15	7.2	SD...11...
	DCGT 11T3035 EN -A3 ...					■	■	■																		11.6	0.35	7.2	SD...11...

Application range of chip breaker

Properties:

- polished rake
- ground clearance
- little rounded cutting edge "E"
- submicrograin carbide, heat and wear resistant

Optimal chip breaking

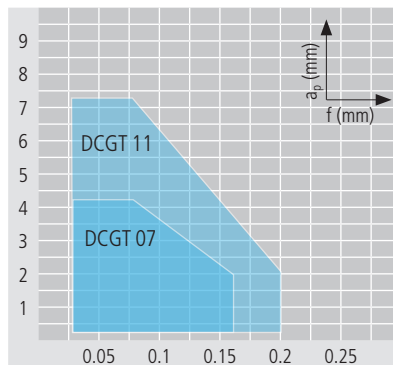

Application:

- finishing
- chip breaker for general application
- stainless steel, alloyed steel, titanium, super alloy, aluminum and synthetics reinforced/composites

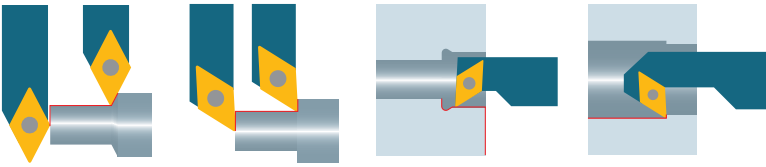

DCCTG ... -PA3

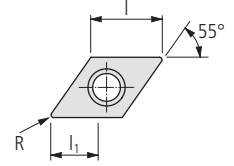

Order designation	Carbide												Cermet				Diamond			Dimensions			Holder
	UHM 10	UHM 10 HX	UHM 10 TX+	UHM 10 MZ	UHM 20	UHM 20 HPX	UHM 20 TX+	UHM 20 MZ	UHM 30	UHM 30 HX	UHM 30 TX+	UHM 30 MZ	UHM 30 SX	UCM 10	UCM 10 HX	UCM 10 MZ	UCVD 08	UPCD 15	UPCD 20	I	R	I ₁	□ 227...
	-	-	●	●	○	●	●	●	○	●	●	○	●	●	●	-	-	-	-	-	-	-	-
	○	●	●	-	-	○	●	●	○	●	●	-	-	○	-	-	-	-	-	-	-	-	-
	●	○	-	-	-	-	-	-	-	-	-	-	-	-	-	-	-	-	-	-	-	-	-
	-	-	●	-	-	●	○	-	-	-	-	-	-	-	-	-	●	●	●	-	-	-	-

STANDARD-LINE

	DCGT 070204 FN -PA3 ...	DCGT 11T304 FN -PA3 ...	DCGT 11T308 FN -PA3 ...	I	R	I ₁	Holder
N	■ ■ ■	■ ■ ■	■ ■ ■	7.75	0.4	4	SD...07...
				11.6	0.4	6.2	SD...11...
				11.6	0.8	6.2	SD...11...

Application range of chip breaker

Properties:

- polished rake
- ground clearance
- sharp cutting edge "F"
- micrograin carbide, heat and wear resistant

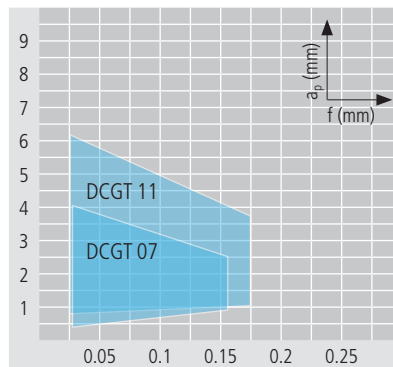

Optimal chip breaking

Application:

- micro finishing
- chip breaker for materials with difficult chip control
- stainless steel, alloyed steel, titanium, super alloy, aluminum and synthetics reinforced/ composites



DCGT ... -PA5

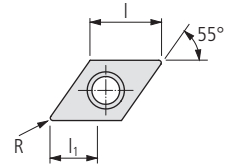

β : 25°
 s : ±0.13
 C : <0.002

Order designation	Carbide												Cermet		Diamond		Dimensions			Holder			
	UHM 10	UHM 10 HX	UHM 10 TX+	UHM 10 MZ	UHM 20	UHM 20 HPX	UHM 20 TX+	UHM 20 MZ	UHM 30	UHM 30 HX	UHM 30 TX+	UHM 30 MZ	UHM 30 SX	UCM 10	UCM 10 HX	UCM 10 MZ	UCVD 08	UPCD 15	UPCD 20	I	R	l ₁	□ 227...
	-	-	●	●	○	●	●	○	○	○	○	○	○	○	○	○	-	-	-				
	○	●	●	-	○	●	●	○	○	○	○	○	○	○	○	○	-	-	-				
	○	○	-	-	-	-	-	-	-	-	-	-	-	-	-	-	-	-	-				
	-	-	●	-	-	○	○	-	-	-	-	-	-	-	-	-	●	●	●				

STANDARD-LINE

	DCGT 070202 FN -PA5 ...	DCGT 070204 FN -PA5 ...	DCGT 11T302 FN -PA5 ...	DCGT 11T304 FN -PA5 ...	DCGT 11T308 FN -PA5 ...																			
N	■	■	■	■	■																			
	7.75	7.75	11.6	11.6	11.6																			
	0.2	0.4	0.2	0.4	0.8																			
	4.1	4.1	7.2	7.2	7.2																			
	SD...07...	SD...07...	SD...11...	SD...11...	SD...11...																			

Application range of chip breaker

Properties:

- polished rake
- ground clearance
- sharp cutting edge "F"
- submicrograin carbide, heat and wear resistant

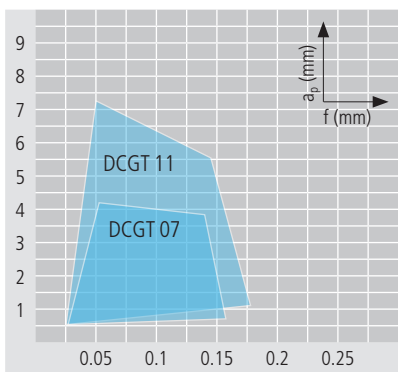

Optimal chip breaking

Application:

- finishing and micro finishing
- chip breaker for materials with difficult chip control
- stainless steel, alloyed steel, titanium, super alloy, aluminum and synthetics reinforced/ composites



206

UTILIS
multidec
swiss type tools



DCGT ... -TOP5*

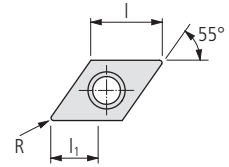

Order designation	Carbide													Cermet			Diamond		Dimensions			Holder	
	UHM 10	UHM 10 HX	UHM 10 TX+	UHM 10 MZ	UHM 20	UHM 20 HPX	UHM 20 TX+	UHM 20 MZ	UHM 30	UHM 30 HX	UHM 30 TX+	UHM 30 MZ	UHM 30 SX	UCM 10	UCM 10 HX	UCM 10 MZ	UCVD 08	UPCD 15	UPCD 20	l	R	l ₁	□ 227...
	-	-	●	●	○	●	●	○	○	●	●	○	○	●	●	○	-	-	-	11.6	0.4	7.2	SD...11...
	-	-	●	●	○	●	●	○	○	●	●	○	○	●	●	○	-	-	-	11.6	0.8	7.2	SD...11...
	○	○	-	-	-	○	○	-	-	-	-	-	-	-	-	-	-	-	-	-	-	-	-
	-	-	●	●	-	○	○	-	-	-	-	-	-	-	-	-	-	-	-	-	-	-	-

STANDARD-LINE

L	DCGT 11T304 FL -TOP5 ...	■	■	□																11.6	0.4	7.2	SD...11...
	DCGT 11T308 FL -TOP5 ...	■	■	□																	11.6	0.8	7.2
N	DCGT 11T304 FN -TOP5 ...	■	■	□																11.6	0.4	7.2	SD...11...
	DCGT 11T308 FN -TOP5 ...	■	■	□																	11.6	0.8	7.2
R	DCGT 11T304 FR -TOP5 ...	■	■	□																11.6	0.4	7.2	SD...11...
	DCGT 11T308 FR -TOP5 ...	■	■	□																	11.6	0.8	7.2

* Description TOP □ 13

Application range of chip breaker

Properties:

- polished rake and ground clearance
- sharp cutting edge "F"
- micrograin carbide, heat and wear resistant
- TOP system, for a better surface finish

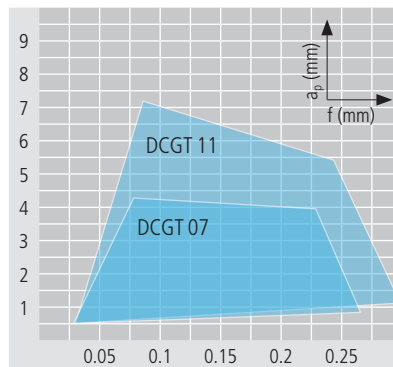

Optimal chip breaking

Application:

- finishing for 20–100 % higher feed rates compared to the standard
- chip breaker for materials with difficult chip control
- stainless steel, alloyed steel, titanium, super alloy, aluminum and synthetics reinforced/composites

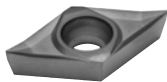
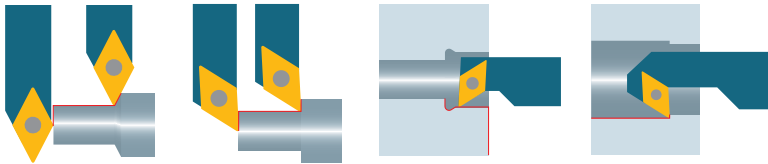

DCGT ... -PA7

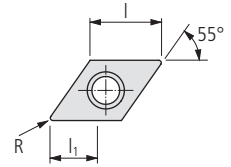

Order designation	Carbide												Cermet		Diamond		Dimensions			Holder			
	UHM 10	UHM 10 HX	UHM 10 TX+	UHM 10 MZ	UHM 20	UHM 20 HPX	UHM 20 TX+	UHM 20 MZ	UHM 30	UHM 30 HX	UHM 30 TX+	UHM 30 MZ	UHM 30 SX	UCM 10	UCM 10 HX	UCM 10 MZ	UCVD 08	UPCD 15	UPCD 20	l	R	l ₁	227...
	-	-	●	●	○	●	●	○	○	○	○	○	○	○	○	○	○	○	○				
	○	○	○	○	○	○	○	○	○	○	○	○	○	○	○	○	○	○	○				
	○	○	○	○	○	○	○	○	○	○	○	○	○	○	○	○	○	○	○				

STANDARD-LINE

N	Order designation	Material												l	R	l ₁	Holder											
		UHM 10	UHM 10 HX	UHM 10 TX+	UHM 10 MZ	UHM 20	UHM 20 HPX	UHM 20 TX+	UHM 20 MZ	UHM 30	UHM 30 HX	UHM 30 TX+	UHM 30 MZ					UHM 30 SX	UCM 10	UCM 10 HX	UCM 10 MZ	UCVD 08	UPCD 15	UPCD 20				
	DCGT 0702005 FN -PA7 ...	■	■	■																				7.75	0.05	4	SD...07...	
	DCGT 070201 FN -PA7 ...	■	■	■																					7.75	0.1	4	SD...07...
	DCGT 070202 FN -PA7 ...	■	■	■																					7.75	0.2	4	SD...07...
	DCGT 070204 FN -PA7 ...	■	■	■																					7.75	0.4	4	SD...07...
	DCGT 11T3005 FN -PA7 ...	■	■	■																					11.6	0.05	7.2	SD...11...
	DCGT 11T301 FN -PA7 ...	■	■	■																					11.6	0.1	7.2	SD...11...
	DCGT 11T302 FN -PA7 ...	■	■	■																					11.6	0.2	7.2	SD...11...
	DCGT 11T304 FN -PA7 ...	■	■	■																					11.6	0.4	7.2	SD...11...
	DCGT 11T308 FN -PA7 ...	■	■	■																					11.6	0.8	7.2	SD...11...

Application range of chip breaker

Properties:

- ground clearance
- sharp cutting edge "F"
- micrograin carbide, heat and wear resistant

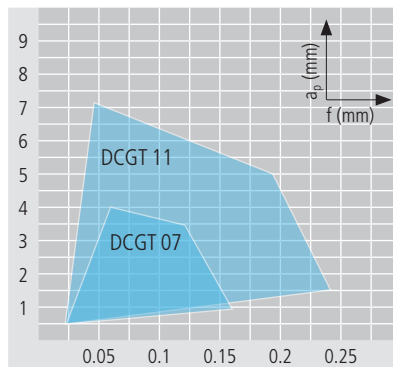

Optimal chip breaking

Application:

- micro finishing
- chip breaker for materials with good chip control
- stainless steel, alloyed steel, titanium, super alloy, aluminum and synthetics reinforced/composites



DCXT ... -PA9

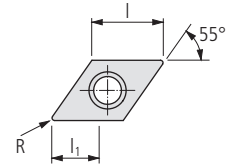

Order designation	Carbide														Cermet		Diamond		Dimensions			Holder
	-	-	●	●	○	●	●	○	○	○	○	○	○	○	○	○	○	○	I	R	I ₁	□ 227...
	UHM 10	UHM 10 HX	UHM 10 TX+	UHM 10 MZ	UHM 20	UHM 20 HPX	UHM 20 TX+	UHM 20 MZ	UHM 30	UHM 30 HX	UHM 30 TX+	UHM 30 MZ	UHM 30 SX	UCM 10	UCM 10 HX	UCM 10 MZ	UCVD 08	UPCD 15	UPCD 20			

VALUE-LINE

N	DCXT 070204 EN -PA9 ...	■	■	□															7.75	0.4	4	SD...07...	
	DCXT 11T304 EN -PA9 ...	■	■	□																11.6	0.4	7.2	SD...11...
	DCXT 11T308 EN -PA9 ...	■	■	□																11.6	0.8	7.2	SD...11...

Application range of chip breaker

Properties:

- high precision sintered insert
- rounded cutting edge "E"
- micrograin carbide, heat and wear resistant
- best performance-cost ratio

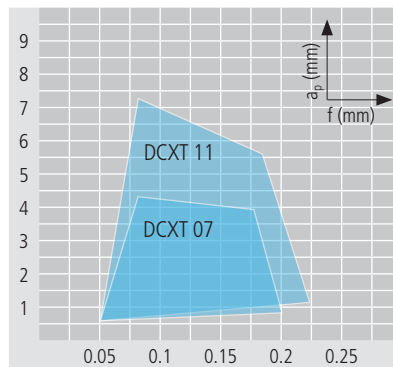

Application:

- finishing
- chip breaker for soft materials with good chip control
- alloyed steel, stainless steel, super alloy, titanium and aluminum



DCGT ... FN -PF

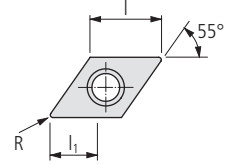

Order designation	Carbide													Cermet			Diamond		Dimensions			Holder	
	UHM 10	UHM 10 HX	UHM 10 TX+	UHM 10 MZ	UHM 20	UHM 20 HPX	UHM 20 TX+	UHM 20 MZ	UHM 30	UHM 30 HX	UHM 30 TX+	UHM 30 MZ	UHM 30 SX	UCM 10	UCM 10 HX	UCM 10 MZ	UCVD 08	UPCD 15	UPCD 20	I	R	L ₁	227...
	-	-	●	●	○	●	●	●	○	○	○	○	○	○	○	○	-	-	-	-	-	-	-
	○	○	○	-	-	○	○	○	○	○	○	○	○	○	○	○	-	-	-	-	-	-	-
	○	○	-	-	-	-	-	-	-	-	-	-	-	-	-	-	-	-	-	-	-	-	-
	○	○	○	○	○	○	○	○	○	○	○	○	○	○	○	○	○	○	○	○	○	○	○

STANDARD-LINE

N	Order designation	Carbide													Cermet			Diamond		Dimensions			Holder	
		UHM 10	UHM 10 HX	UHM 10 TX+	UHM 10 MZ	UHM 20	UHM 20 HPX	UHM 20 TX+	UHM 20 MZ	UHM 30	UHM 30 HX	UHM 30 TX+	UHM 30 MZ	UHM 30 SX	UCM 10	UCM 10 HX	UCM 10 MZ	UCVD 08	UPCD 15	UPCD 20	I	R	L ₁	SD...
	DCGT 070201 FN -PF ...					■	■	■		■	■										7.75	0.1	2.8	SD...07...
	DCGT 070202 FN -PF ...					■	■	■		■	■										7.75	0.2	2.8	SD...07...
	DCGT 11T302 FN -PF ...					■	■	■		■	■										11.6	0.2	3.9	SD...11...
	DCGT 11T304 FN -PF ...					■	■	■		■	■										11.6	0.4	3.9	SD...11...

Application range of chip breaker

Properties:

- ground clearance
- sharp cutting edge "F"
- carbide and cermet in different grades

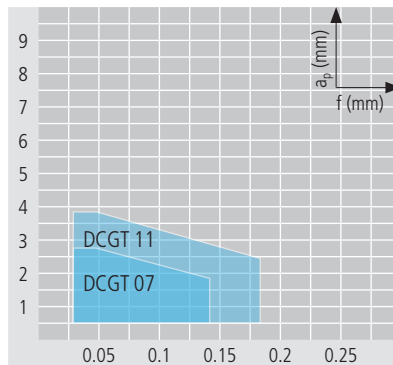

Application:

- finishing and micro finishing
- chip breaker for general application
- alloyed steel and stainless steel

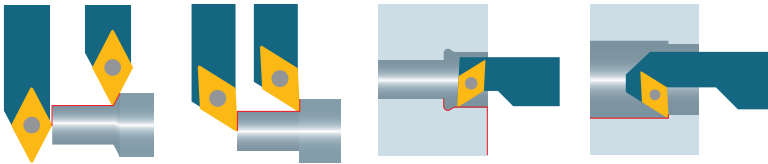

DCGT ... EN -PF

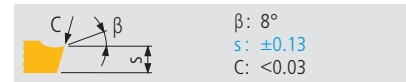
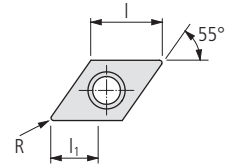

Order designation	Carbide												Cermet		Diamond		Dimensions			Holder			
	UHM 10	UHM 10 HX	UHM 10 TX+	UHM 10 MZ	UHM 20	UHM 20 HPX	UHM 20 TX+	UHM 20 MZ	UHM 30	UHM 30 HX	UHM 30 TX+	UHM 30 MZ	UHM 30 SX	UCM 10	UCM 10 HX	UCM 10 MZ	UCVD 08	UPCD 15	UPCD 20	L	R	l ₁	□ 227...
	-	-	●	●	○	●	●	●	○	●	●	○	●	●	●	-	-	-	-	-	-	-	-
	○	●	●	-	-	○	○	○	○	○	○	○	○	○	○	○	-	-	-	-	-	-	-
	○	○	-	-	-	○	○	○	○	○	○	○	○	○	○	○	○	○	○	○	○	○	○
	-	-	●	-	-	-	-	-	-	-	-	-	-	-	-	-	●	●	●	-	-	-	-

STANDARD-LINE

	DCGT 070201 EN -PF ...	DCGT 070202 EN -PF ...	DCGT 070204 EN -PF ...	DCGT 11T302 EN -PF ...	DCGT 11T304 EN -PF ...	DCGT 11T308 EN -PF ...																		
N																								

Application range of chip breaker

- Properties:**
- ground clearance
 - little rounded cutting edge "E"
 - carbide and cermet in different grades

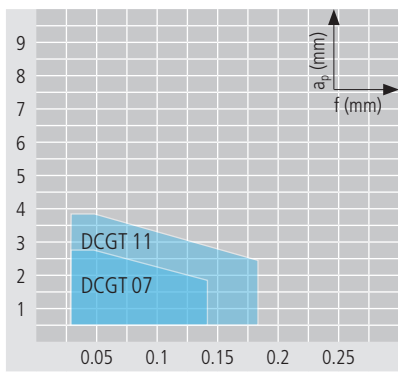

- Application:**
- finishing
 - chip breaker for general application
 - alloyed steel and stainless steel



DCMT ... -PF

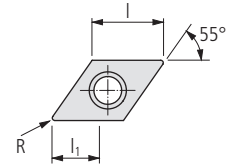

Order designation	Carbide														Cermet		Diamond		Dimensions			Holder	
	UHM 10	UHM 10 HX	UHM 10 TX+	UHM 10 MZ	UHM 20	UHM 20 HPX	UHM 20 TX+	UHM 20 MZ	UHM 30	UHM 30 HX	UHM 30 TX+	UHM 30 MZ	UHM 30 SX	UCM 10	UCM 10 HX	UCM 10 MZ	UCVD 08	UPCD 15	UPCD 20	l	R	l ₁	□ 227...
	-	-	●	●	○	●	●	●	○	○	●	●	○	●	●	●	-	-	-				
	○	●	●	-	-	○	○	○	○	○	○	○	○	○	○	○	-	-	-				
	-	○	-	-	-	-	-	-	-	-	-	-	-	-	-	-	-	-	-				
	-	○	●	-	-	○	○	-	○	○	-	-	-	-	-	-	●	●	●				

VALUE-LINE

	DCMT 070204 EN -PF ...																								
N			■			■			■																
			■			■			■																
			■			■			■																

Application range of chip breaker

- Properties:**
- sintered insert based on ISO standard
 - rounded cutting edge "E"
 - carbide and cermet in different grades

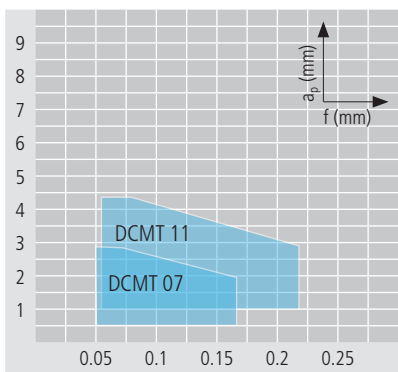

- Application:**
- roughing
 - chip breaker for general application
 - alloyed steel and stainless steel

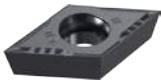
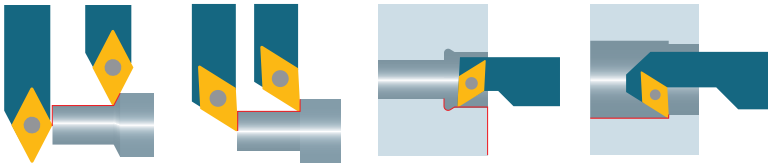

DCET ... -PF05

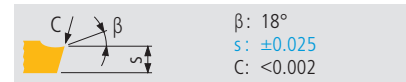
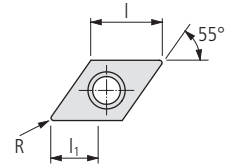

Order designation	Carbide												Cermet		Diamond		Dimensions			Holder			
	UHM 10	UHM 10 HX	UHM 10 TX+	UHM 10 MZ	UHM 20	UHM 20 HPX	UHM 20 TX+	UHM 20 MZ	UHM 30	UHM 30 HX	UHM 30 TX+	UHM 30 MZ	UHM 30 SX	UCM 10	UCM 10 HX	UCM 10 MZ	UCVD 08	UPCD 15	UPCD 20	I	R	I ₁	□ 227...
	-	-	●	●	●	●	●	●	●	●	●	●	●	●	●	●	-	-	-				
	-	●	●	●	●	●	●	●	●	●	●	●	●	●	●	●	-	-	-				
	○	○	-	-	-	-	-	-	-	-	-	-	-	-	-	-	-	-	-				
	-	-	●	-	-	-	-	-	-	-	-	-	-	-	-	-	●	●	●				

PREMIUM-LINE

N	Order designation	Material												Dimensions			Holder	
		Al	St	Ti	AlTi	AlTiZr	AlTiZrN	AlTiZrN	AlTiZrN	AlTiZrN	AlTiZrN	AlTiZrN	AlTiZrN	AlTiZrN	I	R	I ₁	SD...
	DCET 0702005 FN -PF05	■													7.75	0.05	2	SD...07...
	DCET 070201 FN -PF05	■													7.75	0.1	2	SD...07...
	DCET 0702015 FN -PF05	■													7.75	0.15	2	SD...07...
	DCET 070202 FN -PF05	■													7.75	0.2	2	SD...07...
	DCET 11T3005 FN -PF05		■												11.6	0.05	3	SD...11...
	DCET 11T301 FN -PF05		■												11.6	0.1	3	SD...11...
	DCET 11T3015 FN -PF05		■												11.6	0.15	3	SD...11...
	DCET 11T302 FN -PF05		■												11.6	0.2	3	SD...11...
	DCET 11T304 FN -PF05		■												11.6	0.4	3	SD...11...

Application range of chip breaker

Properties:

- polished rake
- ground clearance
- sharp cutting edge "F"
- submicrograin carbide, heat and wear resistant

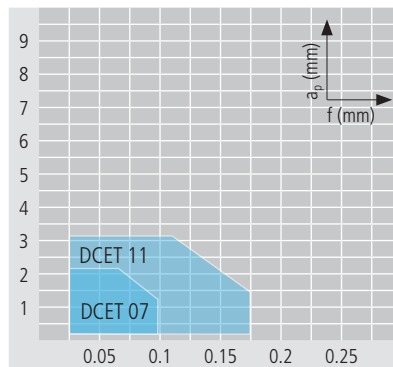

Application:

- micro finishing
- chip breaker for materials with difficult chip control
- stainless steels, titanium, super alloys, aluminium and GRP/CRP



DCGT ... FN -PF23

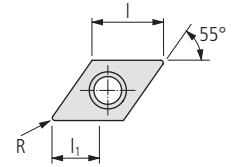

Order designation	Carbide												Cermet			Diamond			Dimensions			Holder	
	UHM 10	UHM 10 HX	UHM 10 TX+	UHM 10 MZ	UHM 20	UHM 20 HPX	UHM 20 TX+	UHM 20 MZ	UHM 30	UHM 30 HX	UHM 30 TX+	UHM 30 MZ	UHM 30 SX	UCM 10	UCM 10 HX	UCM 10 MZ	UCVD 08	UPCD 15	UPCD 20	I	R	l ₁	□ 227...
	-	-	●	●	○	●	●	●	○	●	●	○	●	●	●	○	-	-	-				
	○	●	●	-	-	○	○	○	○	○	○	○	○	○	○	○	-	-	-				
	○	○	-	-	-	-	-	-	-	-	-	-	-	-	-	-	-	-	-				
	-	-	●	-	-	○	○	○	-	-	-	-	-	-	-	-	●	●	●				

STANDARD-LINE

N	Order designation	Carbide												Cermet			Diamond			Dimensions			Holder		
		UHM 10	UHM 10 HX	UHM 10 TX+	UHM 10 MZ	UHM 20	UHM 20 HPX	UHM 20 TX+	UHM 20 MZ	UHM 30	UHM 30 HX	UHM 30 TX+	UHM 30 MZ	UHM 30 SX	UCM 10	UCM 10 HX	UCM 10 MZ	UCVD 08	UPCD 15	UPCD 20	I	R	l ₁	SD...	
	DCGT 0702005 FN -PF23 ...					■	■	■		■											7.75	0.05	3.6	SD...07...	
	DCGT 070201 FN -PF23 ...					■	■	■		■												7.75	0.1	3.6	SD...07...
	DCGT 070202 FN -PF23 ...					■	■	■		■												7.75	0.2	3.6	SD...07...
	DCGT 11T3005 FN -PF23 ...					■	■	■		■												11.6	0.05	5.2	SD...11...
	DCGT 11T301 FN -PF23 ...					■	■	■		■												11.6	0.1	5.2	SD...11...
	DCGT 11T302 FN -PF23 ...					■	■	■		■												11.6	0.2	5.2	SD...11...

Application range of chip breaker

Properties:

- polished rake
- ground clearance
- sharp cutting edge "F"
- micrograin carbide

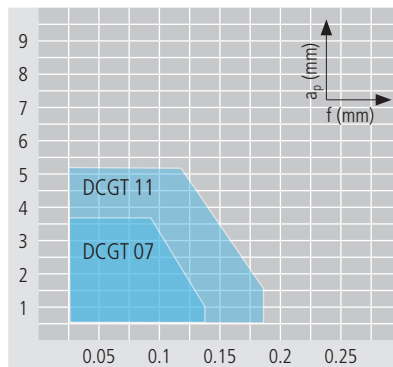

Optimal chip breaking

Application:

- micro finishing
- chip breaker for materials with difficult chip control
- alloyed steel and stainless steel

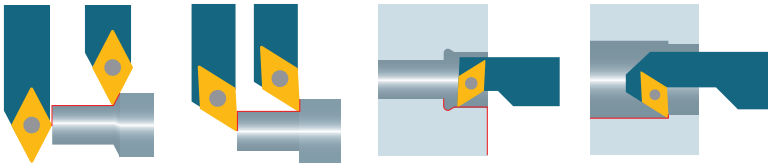

214

UTILIS
multidec
swiss type tools



DCGT ... EN -PF23

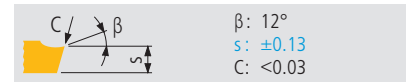
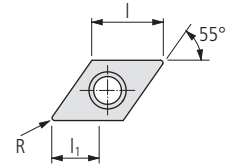

Order designation	Carbide												Cermet		Diamond		Dimensions			Holder			
	UHM 10	UHM 10 HX	UHM 10 TX+	UHM 10 MZ	UHM 20	UHM 20 HPX	UHM 20 TX+	UHM 20 MZ	UHM 30	UHM 30 HX	UHM 30 TX+	UHM 30 MZ	UHM 30 SX	UCM 10	UCM 10 HX	UCM 10 MZ	UCVD 08	UPCD 15	UPCD 20	L	R	L ₁	□ 227 ...
	-	-	●	●	○	●	●	○	○	●	●	○	○	○	○	○	-	-	-	7.75	0.03	3.6	SD...07...
	○	●	●	-	○	●	●	-	○	●	●	-	-	○	○	-	-	-	7.75	0.05	3.6	SD...07...	
	○	○	-	-	-	-	-	-	-	-	-	-	-	-	-	-	-	-	7.75	0.1	3.6	SD...07...	
	○	○	-	-	-	-	-	-	-	-	-	-	-	-	-	-	-	-	7.75	0.2	3.6	SD...07...	
	○	○	-	-	-	-	-	-	-	-	-	-	-	-	-	-	-	-	11.6	0.05	5.2	SD...11...	
	○	○	-	-	-	-	-	-	-	-	-	-	-	-	-	-	-	-	11.6	0.1	5.2	SD...11...	
	○	○	-	-	-	-	-	-	-	-	-	-	-	-	-	-	-	-	11.6	0.2	5.2	SD...11...	

STANDARD-LINE

	DCGT 0702003 EN -PF23 ...	DCGT 0702005 EN -PF23 ...	DCGT 070201 EN -PF23 ...	DCGT 070202 EN -PF23 ...	DCGT 11T3005 EN -PF23 ...	DCGT 11T301 EN -PF23 ...	DCGT 11T302 EN -PF23 ...																
N								■															
					■	■	■																
					■	■	■																
					■	■	■																
					■	■	■																
					■	■	■																

Application range of chip breaker

Properties:

- polished rake
- ground clearance
- little rounded cutting edge "E"
- micrograin carbide

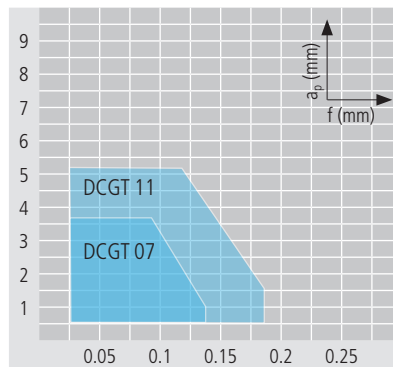

Optimal chip breaking

Application:

- finishing
- chip breaker for materials with difficult chip control
- alloyed steel and stainless steel

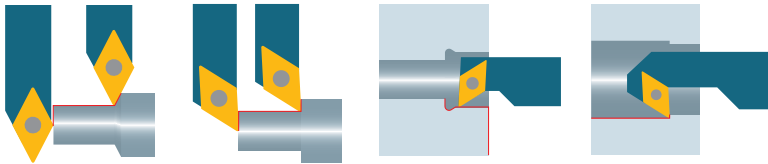

DCGT ... FN -PF33

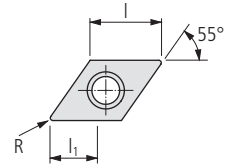

Order designation	Carbide												Cermet	Diamond		Dimensions			Holder					
	UHM 10	UHM 10 HX	UHM 10 TX+	UHM 10 MZ	UHM 20	UHM 20 HPX	UHM 20 TX+	UHM 20 MZ	UHM 30	UHM 30 HX	UHM 30 TX+	UHM 30 MZ		UHM 30 SX	UCM 10	UCM 10 HX	UCM 10 MZ	UCVD 08	UPCD 15	UPCD 20	I	R	l ₁	□ 227...
	-	-	●	●	○	●	●	●	○	○	●	●	○	●	●	●	-	-	-	-	-	-	-	-
	○	●	●	-	-	○	○	○	○	○	○	○	○	○	○	○	-	-	-	-	-	-	-	-
	●	○	-	-	-	-	-	-	-	-	-	-	-	-	-	-	●	●	●	-	-	-	-	-
	-	-	●	-	-	-	-	-	-	-	-	-	-	-	-	-	-	-	-	-	-	-	-	-

STANDARD-LINE

N	Order designation	Carbide												Cermet	Diamond		Dimensions			Holder										
		UHM 10	UHM 10 HX	UHM 10 TX+	UHM 10 MZ	UHM 20	UHM 20 HPX	UHM 20 TX+	UHM 20 MZ	UHM 30	UHM 30 HX	UHM 30 TX+	UHM 30 MZ		UHM 30 SX	UCM 10	UCM 10 HX	UCM 10 MZ	UCVD 08	UPCD 15	UPCD 20	I	R	l ₁	SD...					
	DCGT 0702005 FN -PF33 ...					■	■	■			■															7.75	0.05	3.6	SD...07...	
	DCGT 070201 FN -PF33 ...					■	■	■			■																7.75	0.1	3.6	SD...07...
	DCGT 070202 FN -PF33 ...					■	■	■			■																7.75	0.2	3.6	SD...07...
	DCGT 070204 FN -PF33 ...					■	■	■			■																7.75	0.4	3.6	SD...07...
	DCGT 11T3005 FN -PF33 ...					■	■	■			■																11.6	0.05	5.2	SD...11...
	DCGT 11T301 FN -PF33 ...					■	■	■			■																11.6	0.1	5.2	SD...11...
	DCGT 11T302 FN -PF33 ...					■	■	■			■																11.6	0.2	5.2	SD...11...
	DCGT 11T304 FN -PF33 ...					■	■	■			■																11.6	0.4	5.2	SD...11...

Application range of chip breaker

Properties:

- polished rake
- ground clearance
- sharp cutting edge "F"
- micrograin carbide

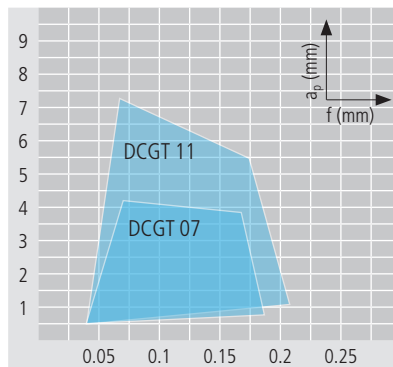

Optimal chip breaking

Application:

- micro finishing
- chip breaker for materials with difficult chip control
- alloyed steel and stainless steel

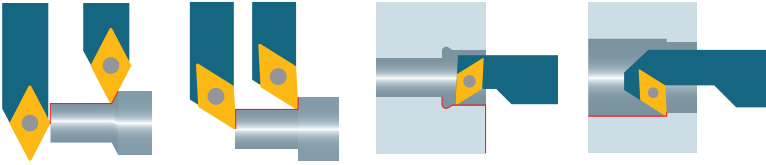

DCGT ... EN -PF33

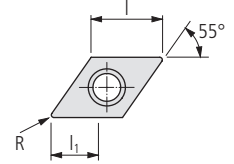

Order designation	Carbide												Cermet		Diamond		Dimensions			Holder			
	UHM 10	UHM 10 HX	UHM 10 TX+	UHM 10 MZ	UHM 20	UHM 20 HPX	UHM 20 TX+	UHM 20 MZ	UHM 30	UHM 30 HX	UHM 30 TX+	UHM 30 MZ	UHM 30 SX	UCM 10	UCM 10 HX	UCM 10 MZ	UCVD 08	UPCD 15	UPCD 20	L	R	L ₁	□ 227...
	-	-	●	●	○	●	●	●	○	●	●	○	○	●	●	○	-	-	-				
	○	●	●	-	-	○	○	-	-	○	○	-	-	○	○	-	-	-	-				
	○	○	-	-	-	-	-	-	-	-	-	-	-	-	-	-	●	●	●				
	-	-	●	-	-	-	-	-	-	-	-	-	-	-	-	-	-	-	-				

STANDARD-LINE

	DCGT 0702005 EN -PF33 ...	DCGT 070201 EN -PF33 ...	DCGT 070202 EN -PF33 ...	DCGT 070204 EN -PF33 ...	DCGT 11T3005 EN -PF33 ...	DCGT 11T301 EN -PF33 ...	DCGT 11T302 EN -PF33 ...	DCGT 11T304 EN -PF33 ...															
N					■	■	■													7.75	0.05	3.6	SD...07...
					■	■	■													7.75	0.1	3.6	SD...07...
					■	■	■													7.75	0.2	3.6	SD...07...
					■	■	■													7.75	0.4	3.6	SD...07...
					■	■	■													11.6	0.05	5.2	SD...11...
					■	■	■													11.6	0.1	5.2	SD...11...
					■	■	■													11.6	0.2	5.2	SD...11...
					■	■	■													11.6	0.4	5.2	SD...11...

Application range of chip breaker

Properties:

- polished rake
- ground clearance
- little rounded cutting edge "E"
- micrograin carbide

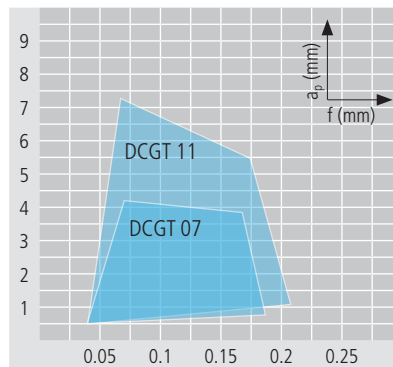

Optimal chip breaking

Application:

- finishing
- chip breaker for materials with difficult chip control
- alloyed steel and stainless steel



DCMT ... -PF43

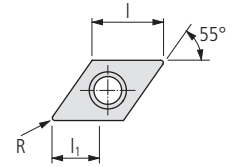

Order designation	Carbide														Cermet		Diamond		Dimensions			Holder	
	UHM 10	UHM 10 HX	UHM 10 TX+	UHM 10 MZ	UHM 20	UHM 20 HPX	UHM 20 TX+	UHM 20 MZ	UHM 30	UHM 30 HX	UHM 30 TX+	UHM 30 MZ	UHM 30 SX	UCM 10	UCM 10 HX	UCM 10 MZ	UCVD 08	UPCD 15	UPCD 20	I	R	l ₁	□ 227...
	-	-	●	●	○	●	●	○	○	○	○	○	○	○	○	○	-	-	-				
	○	●	●	-	-	○	○	○	○	○	○	○	○	○	○	○	-	-	-				
	○	○	-	-	-	○	○	-	-	-	-	-	-	-	-	-	-	-	-				
	-	○	●	-	-	○	○	-	-	-	-	-	-	-	-	-	●	●	●				

VALUE-LINE

	DCMT 070202 EN -PF43 ...	DCMT 070204 EN -PF43 ...	DCMT 11T302 EN -PF43 ...	DCMT 11T304 EN -PF43 ...	DCMT 11T308 EN -PF43 ...																			
N						■					■										7.75	0.2	3.8	SD...07...
											■										7.75	0.4	3.8	SD...07...
											■										11.6	0.2	5.5	SD...11...
											■										11.6	0.4	5.5	SD...11...
											■										11.6	0.8	5.5	SD...11...

Application range of chip breaker

- Properties:**
- sintered insert based on ISO standard
 - rounded cutting edge "E"
 - micrograin carbide

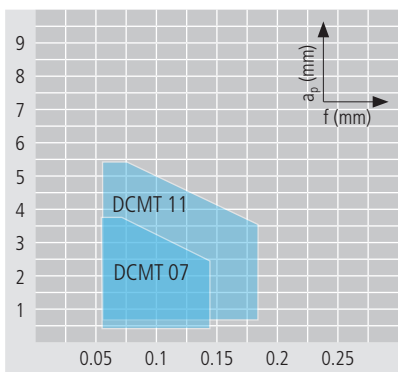

- Application:**
- roughing and finishing
 - chip breaker for materials with difficult chip control
 - alloyed steel and stainless steel

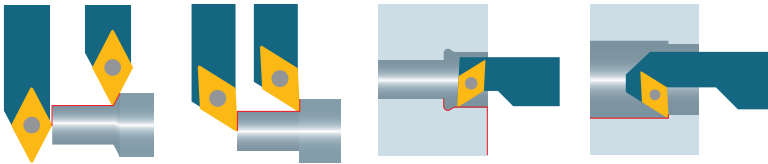

DCMT ... -PM

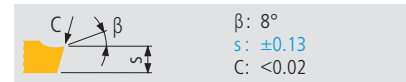
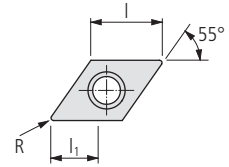

β : 8°
s: ±0.13
C: <0.02

Order designation	Carbide													Cermet	Diamond	Dimensions			Holder □ 227...					
	UHM 10	UHM 10 HX	UHM 10 TX+	UHM 10 MZ	UHM 20	UHM 20 HPX	UHM 20 TX+	UHM 20 MZ	UHM 30	UHM 30 HX	UHM 30 TX+	UHM 30 MZ	UHM 30 SX			UCM 10	UCM 10 HX	UCM 10 MZ		UCVD 08	UPCD 15	UPCD 20	I	R
	-	-	●	●	●	●	●	●	●	●	●	●	●	●	●	●	-	-	-	-	-	-	-	-
	○	●	●	-	-	○	○	○	○	○	○	○	○	○	○	○	-	-	-	-	-	-	-	-
	●	○	-	-	-	○	○	○	○	○	○	○	○	○	○	○	●	●	●	●	●	●	●	●
	-	-	●	-	-	-	-	-	-	-	-	-	-	-	-	-	-	-	-	-	-	-	-	-

VALUE-LINE

	DCMT 070204 EN -PM ...	DCMT 070208 EN -PM ...	DCMT 11T304 EN -PM ...	DCMT 11T308 EN -PM ...	I	R	I ₁	Holder
N		■		■	7.75	0.4	2.6	SD...07...
			■		7.75	0.8	2.6	SD...07...
			■	■	11.6	0.4	4.1	SD...11...
			■	■	11.6	0.8	4.1	SD...11...

Application range of chip breaker

Properties:

- sintered insert based on ISO standard
- rounded cutting edge "E"
- micrograin carbide

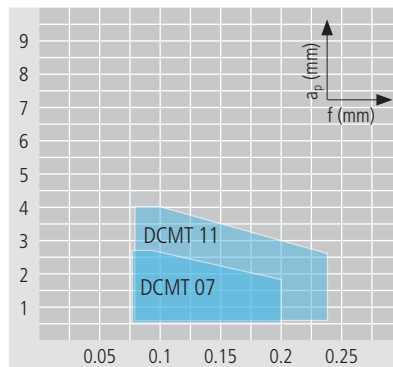

Optimal chip breaking

Application:

- roughing
- chip breaker for general application
- alloyed steel and stainless steel

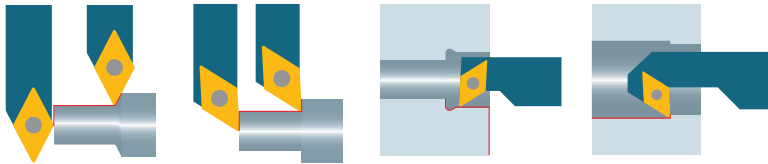

DCMT ... -PMF

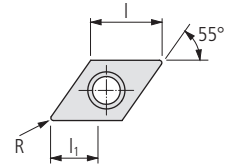

Order designation	Carbide														Cermet		Diamond		Dimensions			Holder	
	UHM 10	UHM 10 HX	UHM 10 TX+	UHM 10 MZ	UHM 20	UHM 20 HPX	UHM 20 TX+	UHM 20 MZ	UHM 30	UHM 30 HX	UHM 30 TX+	UHM 30 MZ	UHM 30 SX	UCM 10	UCM 10 HX	UCM 10 MZ	UCVD 08	UPCD 15	UPCD 20	l	R	l ₁	227...
	-	-	●	●	○	●	●	●	○	○	○	○	○	○	○	○	-	-	-				
	○	●	●	-	-	○	○	○	○	○	○	○	○	○	○	○	-	-	-				
	○	○	-	-	-	-	-	-	-	-	-	-	-	-	-	-	-	-	-				
	-	-	●	-	-	○	○	○	○	○	○	○	○	○	○	○	○	○	○				

VALUE-LINE

N	Order designation	UHM 10	UHM 10 HX	UHM 10 TX+	UHM 10 MZ	UHM 20	UHM 20 HPX	UHM 20 TX+	UHM 20 MZ	UHM 30	UHM 30 HX	UHM 30 TX+	UHM 30 MZ	UHM 30 SX	UCM 10	UCM 10 HX	UCM 10 MZ	UCVD 08	UPCD 15	UPCD 20	l	R	l ₁	Holder	
	DCMT 070202 EN -PMF														■						7.75	0.2	2.6	SD...07...	
	DCMT 070204 EN -PMF														■							7.75	0.4	2.6	SD...07...
	DCMT 11T304 EN -PMF														■							11.6	0.4	4.1	SD...11...
	DCMT 11T308 EN -PMF														■							11.6	0.8	4.1	SD...11...

Application range of chip breaker

Properties:

- sintered insert based on ISO standard
- rounded cutting edge "E"
- micrograin carbide

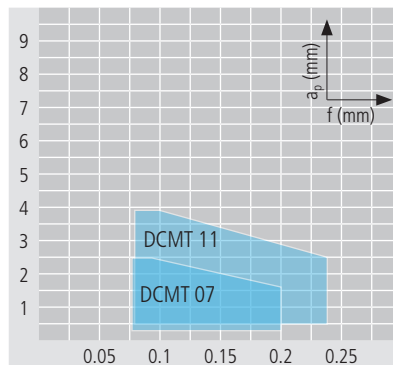

Optimal chip breaking

Application:

- roughing and finishing
- chip breaker for general application
- alloyed steel and stainless steel

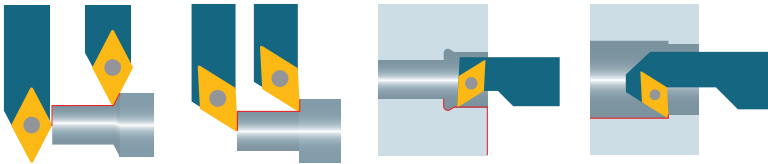

DCMT ... -PM25

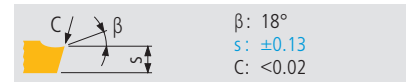
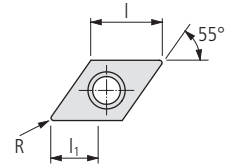

Order designation	Carbide												Cermet	Diamond	Dimensions			Holder □ 227...						
	UHM 10	UHM 10 HX	UHM 10 TX+	UHM 10 MZ	UHM 20	UHM 20 HPX	UHM 20 TX+	UHM 20 MZ	UHM 30	UHM 30 HX	UHM 30 TX+	UHM 30 MZ			UHM 30 SX	UCM 10	UCM 10 HX		UCM 10 MZ	UCVD 08	UPCD 15	UPCD 20	l	R
	-	-	●	●	●	●	●	●	●	●	●	●	●	●	●	●	-	-	-	-	-	-	-	-
	○	○	○	-	-	○	○	○	○	○	○	○	○	○	○	○	-	-	-	-	-	-	-	-
	●	○	-	-	-	-	-	-	-	-	-	-	-	-	-	-	●	●	●	●	●	●	●	
	-	-	●	-	-	-	-	-	-	-	-	-	-	-	-	-	-	-	-	-	-	-	-	

VALUE-LINE

	DCMT 070202 EN -PM25 ...	DCMT 070204 EN -PM25 ...	DCMT11T302 EN -PM25 ...	DCMT11T304 EN -PM25 ...	DCMT11T308 EN -PM25 ...	l	R	l ₁	Holder
N	■	■	■	■	■	7.75	0.2	1.6	SD...07...
						7.75	0.4	2	SD...07...
						11.6	0.2	2	SD...11...
						11.6	0.4	2.2	SD...11...
						11.6	0.8	3.2	SD...11...

Application range of chip breaker

Properties:

- sintered insert based on ISO standard
- rounded cutting edge "E"
- micrograin carbide

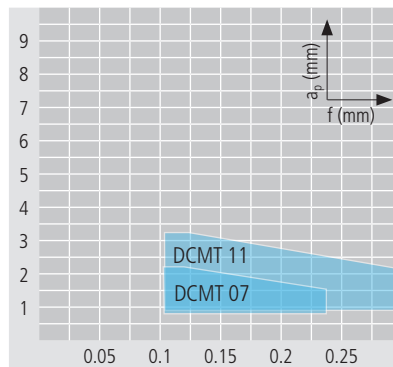

Optimal chip breaking

Application:

- roughing and finishing
- chip breaker for materials with difficult chip control
- stainless steel

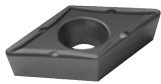

DCMT ... -PM55

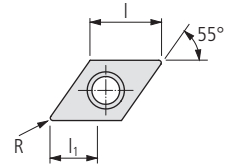

Order designation	Carbide												Cermet	Diamond		Dimensions			Holder					
	UHM 10	UHM 10 HX	UHM 10 TX+	UHM 10 MZ	UHM 20	UHM 20 HPX	UHM 20 TX+	UHM 20 MZ	UHM 30	UHM 30 HX	UHM 30 TX+	UHM 30 MZ		UHM 30 SX	UCM 10	UCM 10 HX	UCM 10 MZ	UCVD 08	UPCD 15	UPCD 20	I	R	l ₁	227...
	-	-	●	●	○	●	●	●	○	○	●	●	○	○	●	●	○	-	-	-				
	○	●	●	-	-	○	○	○	○	○	○	○	○	○	○	○	○	-	-	-				
	○	○	-	-	-	○	○	○	○	○	○	○	○	○	○	○	-	-	-					
	-	○	-	●	-	○	○	○	○	○	○	○	○	○	○	○	○	○	○					

VALUE-LINE

N	Order designation	UHM 10	UHM 10 HX	UHM 10 TX+	UHM 10 MZ	UHM 20	UHM 20 HPX	UHM 20 TX+	UHM 20 MZ	UHM 30	UHM 30 HX	UHM 30 TX+	UHM 30 MZ	UHM 30 SX	UCM 10	UCM 10 HX	UCM 10 MZ	UCVD 08	UPCD 15	UPCD 20	I	R	l ₁	Holder	
	DCMT 070204 EN -PM55 ...					■															7.75	0.4	2.2	SD...07...	
	DCMT 070208 EN -PM55 ...					■																7.75	0.8	2.4	SD...07...
	DCMT11T304 EN -PM55 ...					■																11.6	0.4	3	SD...11...
	DCMT11T308 EN -PM55 ...					■																11.6	0.8	4	SD...11...

Application range of chip breaker

Properties:

- sintered insert based on ISO standard
- rounded cutting edge "E"
- micrograin carbide

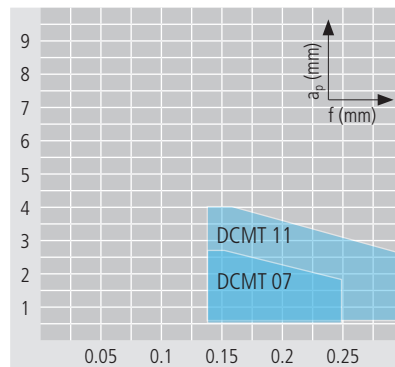

Optimal chip breaking

Application:

- roughing
- chip breaker for general application
- stainless steel

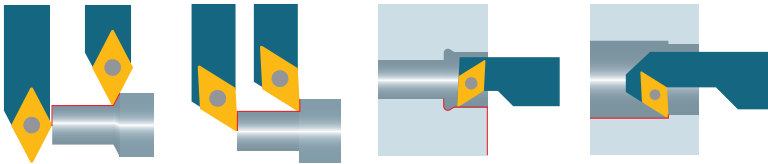

222

UTILIS
multidec
swiss type tools



DCET ... -U

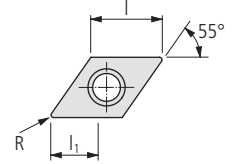

Order designation	Carbide													Cermet		Diamond		Dimensions			Holder		
	UHM 10	UHM 10 HX	UHM 10 TX+	UHM 10 MZ	UHM 20	UHM 20 HPX	UHM 20 TX+	UHM 20 MZ	UHM 30	UHM 30 HX	UHM 30 TX+	UHM 30 MZ	UHM 30 SX	UCM 10	UCM 10 HX	UCM 10 MZ	UCVD 08	UPCD 15	UPCD 20	L	R	L ₁	□ 227...
	-	-	●	●	○	●	●	●	○	●	●	○	○	○	○	○	-	-	-				
	○	●	●	-	-	○	○	○	○	○	○	○	○	○	○	○	-	-	-				
	○	○	-	-	-	-	-	-	-	-	-	-	-	-	-	-	-	-	-				
	-	-	●	-	-	○	○	○	-	-	-	-	-	-	-	-	●	●	●				

PREMIUM-LINE

	DCET 0702003 FR -U ...	DCET 070201 FR -U ...	DCET 070202 FR -U ...	DCET 11T301 FR -U ...	DCET 11T302 FR -U ...	DCET 11T304 FR -U ...																		
R	■	■	■	■	■	■															7.75	0.03	2.5	SD...07...
	■	■	■	■	■	■							■	■							7.75	0.1	2.5	SD...07...
	■	■	■	■	■	■							■	■							7.75	0.2	2.5	SD...07...
	■	■	■	■	■	■							■	■							11.6	0.1	4	SD...11...
	■	■	■	■	■	■							■	■							11.6	0.2	4	SD...11...
	■	■	■	■	■	■															11.6	0.4	4	SD...11...

Application range of chip breaker

Properties:

- ground rake and clearance
- sharp cutting edge "F"
- submicrograin carbide, heat and wear resistant and cermet

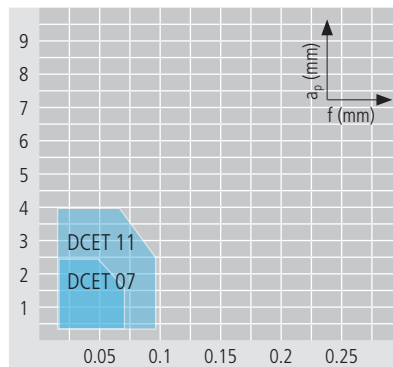

Optimal chip breaking

Application:

- micro finishing
- chip breaker for materials with difficult chip control
- alloyed steel and stainless steel

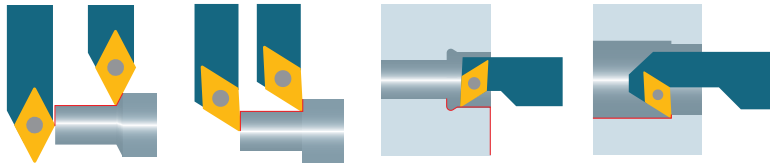

DCGT ...

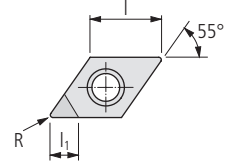

β : 5-7°
 s : ±0.13
 C : <0.002

Order designation	Material													Dimensions			Holder			
	Carbide						C20			Cermet			Diamond			Holder				
	-	-	●	●	○	○	○	○	○	○	○	○	○	○	○	○	I	R	I ₁	□ 227...
	○	●	●	-	-	-	-	-	-	-	-	-	-	-	-	-				
	●	○	-	-	-	-	-	-	-	-	-	-	-	-	-	-				
	-	-	●	○	○	○	○	○	○	○	○	○	○	○	○	○				
	UHM 10	UHM 10 HX	UHM 10 TX+	UHM 10 MZ	UHM 20	UHM 20 HPX	UHM 20 TX+	UHM 20 MZ	UHM 30	UHM 30 HX	UHM 30 TX+	UHM 30 MZ	UHM 30 SX	UCM 10	UCM 10 HX	UCM 10 MZ				
	UCVD 08	UPCD 15	UPCD 20																	

STANDARD-LINE

N	Order designation	Material													Dimensions			Holder			
		Carbide						C20			Cermet			Diamond			Holder				
	DCGT 070201 FN ...																■	7.75	0.1	3.8	SD...07...
	DCGT 070202 FN ...																■	7.75	0.2	3.7	SD...07...
	DCGT 070204 FN ...																■	7.75	0.4	3.4	SD...07...
	DCGT 11T302 FN ...																■	11.6	0.2	4.7	SD...11...
	DCGT 11T304 FN ...																■	11.6	0.4	4.3	SD...11...
	DCGT 11T308 FN ...																■	11.6	0.8	4	SD...11...

Application range of chip breaker

Properties:

- sharp cutting edge "F"
- less cutting force
- positive cut

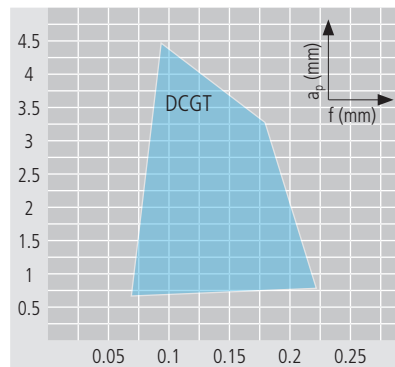

Optimal chip breaking

Application:

- finishing and micro finishing for unstable or thin-walled parts
- chip breaker for general application will generate continuous chip
- aluminum, brass, copper, bronze, platinum, gold, synthetics and synthetics reinforced/composites
- ideal for smallest tolerance and medium surface quality



224

UTILIS
multidec
swiss type tools



DCGT ... -UWS

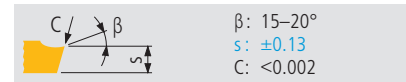
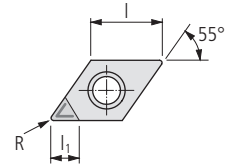

Order designation	Carbide												Cermet		Diamond		Dimensions			Holder			
	UHM 10	UHM 10 HX	UHM 10 TX+	UHM 10 MZ	UHM 20	UHM 20 HPX	UHM 20 TX+	UHM 20 MZ	UHM 30	UHM 30 HX	UHM 30 TX+	UHM 30 MZ	UHM 30 SX	UCM 10	UCM 10 HX	UCM 10 MZ	UCVD 08	UPCD 15	UPCD 20	L	R	L ₁	□ 227...
	-	-	●	●	○	●	●	○	○	○	○	○	○	○	○	○	-	-	-				
	○	●	●	-	-	○	○	○	○	○	○	○	○	○	○	○	-	-	-				
	○	○	-	-	-	-	-	-	-	-	-	-	-	-	-	-	-	-	-				
	-	-	●	-	-	○	○	-	-	-	-	-	-	-	-	-	●	●	●				

STANDARD-LINE

N	Order designation	Carbide												Cermet		Diamond		Dimensions			Holder			
		UHM 10	UHM 10 HX	UHM 10 TX+	UHM 10 MZ	UHM 20	UHM 20 HPX	UHM 20 TX+	UHM 20 MZ	UHM 30	UHM 30 HX	UHM 30 TX+	UHM 30 MZ	UHM 30 SX	UCM 10	UCM 10 HX	UCM 10 MZ	UCVD 08	UPCD 15	UPCD 20	L	R	L ₁	Holder
	DCGT 070201 FN -UWS ...																■	■	■	7.75	0.1	3		SD...07...
	DCGT 070202 FN -UWS ...																■	■	■	7.75	0.2	3		SD...07...
	DCGT 070204 FN -UWS ...																■	■	■	7.75	0.4	3		SD...07...
	DCGT 11T302 FN -UWS ...																■	■	■	11.6	0.2	3		SD...11...
	DCGT 11T304 FN -UWS ...																■	■	■	11.6	0.4	3		SD...11...

Application range of chip breaker

Properties:

- sharp cutting edge "F"
- almost any cutting force
- high positive narrow chip breaker made by laser

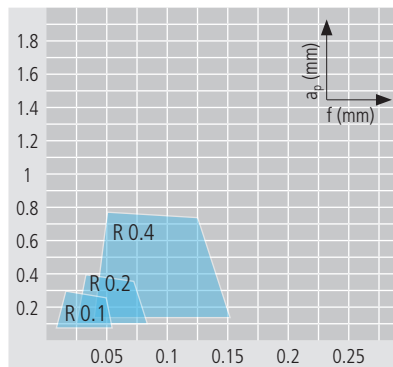

Optimal chip breaking

Application:

- micro finishing for unstable or thin-walled parts
- chip breaker for materials with difficult chip control
- synthetics reinforced/composites, aluminum, platinum, gold and synthetics
- ideal for smallest tolerance and medium surface quality



DCGT ... -UWN

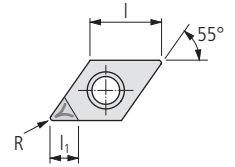

β : 15–20°
 s : ±0.13
 C : <0.005

Order designation	Material														Dimensions			Holder	
	Carbide							□ 20	Cermet				Diamond			□ 227...			
	-	-	●	●	○	○	○	○	○	○	○	○	○	○	○		○	○	○
	○	●	●	-	-	-	-	-	-	-	-	-	-	-	-	-	-	-	
	●	○	-	-	-	-	-	-	-	-	-	-	-	-	-	-	-	-	
	-	-	●	○	○	○	○	○	○	○	○	○	○	○	○	○	○	○	
	UHM 10	UHM 10 HX	UHM 10 TX+	UHM 10 MZ	UHM 20	UHM 20 HPX	UHM 20 TX+	UHM 20 MZ	UHM 30	UHM 30 HX	UHM 30 TX+	UHM 30 MZ	UHM 30 SX	UCM 10	UCM 10 HX	UCM 10 MZ	UCVD 08		
	UPCD 15	UPCD 20																	
	I	R	I ₁																

STANDARD-LINE

N	Order designation	Material														Dimensions			Holder		
		Carbide							□ 20	Cermet				Diamond			□ 227...				
	DCGT 070202 FN -UWN ...															■		■	7.75	0.2	3
	DCGT 070204 FN -UWN ...															■	■	7.75	0.4	3	SD...07...
	DCGT 11T302 FN -UWN ...															■	■	11.6	0.2	3	SD...11...
	DCGT 11T304 FN -UWN ...															■	■	11.6	0.4	3	SD...11...
	DCGT 11T308 FN -UWN ...															■	■	11.6	0.8	3	SD...11...

Application range of chip breaker

- Properties:**
- sharp cutting edge "F"
 - higher cutting force
 - high positive wide chip breaker made by laser

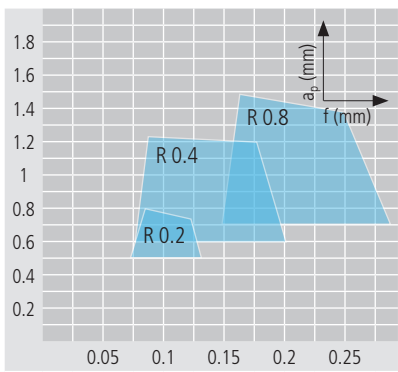

- Application:**
- finishing for stable or solid parts
 - chip breaker for materials with difficult chip control
 - synthetics reinforced/composites, aluminum, platinum, gold and synthetics
 - ideal for smallest tolerance and best surface quality



226

UTILIS
multidec
swiss type tools



DCGW ...

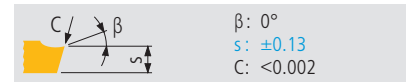
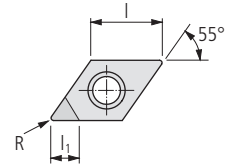

$\beta: 0^\circ$
 $s: \pm 0.13$
 $C: < 0.002$

Order designation	Carbide														Cermet		Diamond		Dimensions			Holder	
	UHM 10	UHM 10 HX	UHM 10 TX+	UHM 10 MZ	UHM 20	UHM 20 HPX	UHM 20 TX+	UHM 20 MZ	UHM 30	UHM 30 HX	UHM 30 TX+	UHM 30 MZ	UHM 30 SX	UCM 10	UCM 10 HX	UCM 10 MZ	UCVD 08	UPCD 15	UPCD 20	l	R	l ₁	□ 227...
	-	-	●	●	○	●	●	○	○	●	●	○	○	●	●	○	-	-	-				
	-	●	●	●	-	●	●	-	-	●	●	-	-	●	●	-	-	-					
	○	○	-	-	-	○	○	-	-	-	-	-	-	-	-	-	-	-					
	-	○	○	○	○	○	○	○	○	○	○	○	○	○	○	○	○	○					

STANDARD-LINE

N	Order designation	Carbide														Cermet		Diamond		l	R	l ₁	Holder	
		UHM 10	UHM 10 HX	UHM 10 TX+	UHM 10 MZ	UHM 20	UHM 20 HPX	UHM 20 TX+	UHM 20 MZ	UHM 30	UHM 30 HX	UHM 30 TX+	UHM 30 MZ	UHM 30 SX	UCM 10	UCM 10 HX	UCM 10 MZ	UCVD 08	UPCD 15	UPCD 20				
	DCGW 0702005 FN ...																■	■	■	7.75	0.05	3.5		SD...07...
	DCGW 070201 FN ...																■	■	■	7.75	0.1	3.8		SD...07...
	DCGW 070202 FN ...																■	■	■	7.75	0.2	3.7		SD...07...
	DCGW 070204 FN ...																■	■	■	7.75	0.4	3.4		SD...07...
	DCGW 070208 FN ...																■	■	■	7.75	0.8	3		SD...07...
	DCGW 11T301 FN ...																■	■	■	11.6	0.1	4.8		SD...11...
	DCGW 11T302 FN ...																■	■	■	11.6	0.2	4.7		SD...11...
	DCGW 11T304 FN ...																■	■	■	11.6	0.4	4.3		SD...11...
	DCGW 11T308 FN ...																■	■	■	11.6	0.8	4		SD...11...

Application range of chip breaker

Properties:

- sharp cutting edge "F"
- medium cutting force
- neutral cut

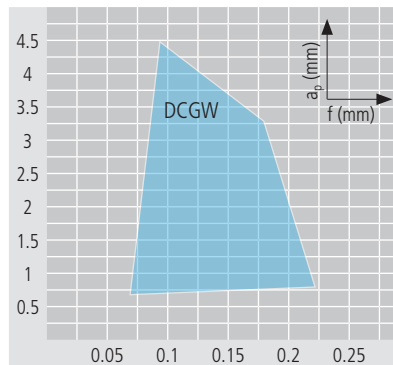

Optimal chip breaking

Application:

- finishing and micro finishing for stable or solid parts
- chip breaker for general application will generate continuous chip
- aluminum, brass, copper, bronze, platinum, gold, synthetics and synthetics reinforced/composites
- ideal for smallest tolerance and high surface quality

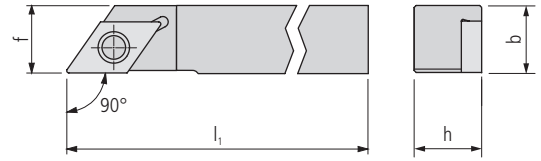
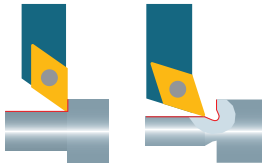

SDAC... U (90°)

Order designation		Dimensions							Inserts
L	R	h	b	l ₁	f				□ 201...

STANDARD-LINE

SDACL 0808 K07 U	■	SDACR 0808 K07 U	■	8	8	125		8			DC..0702..
SDACL 1010 M07 U	■	SDACR 1010 M07 U	■	10	10	150		10			DC..0702..
SDACL 1212 M07 U	■	SDACR 1212 M07 U	■	12	12	150		12			DC..0702..
SDACL 1212 M11 U	■	SDACR 1212 M11 U	■	12	12	150		12			DC..11T3..
SDACL 1616 K11 U	■	SDACR 1616 K11 U	■	16	16	125		16			DC..11T3..

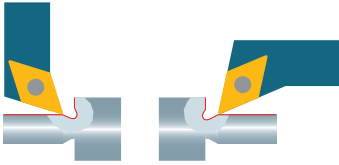

228

UTILIS **multidec**[®]
 swiss type tools

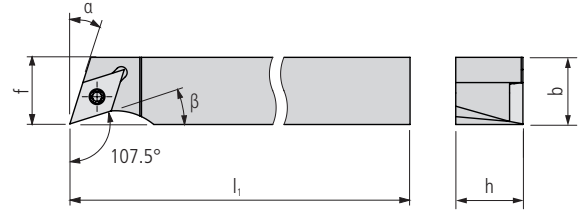

SDHC... U (107.5°)

Order designation		Dimensions								Inserts
L	R	h	b	l ₁		f		α	β	□ 201...

STANDARD-LINE

SDHCL 0808 H07 U	■	SDHCR 0808 H07 U	■	8	8	100		11		17.5°	17.5°	DC..0702..
SDHCL 1010 H07 U	■	SDHCR 1010 H07 U	■	10	10	100		11		17.5°	17.5°	DC..0702..
SDHCL 1212 H07 U	■	SDHCR 1212 H07 U	■	12	12	100		12		17.5°	17.5°	DC..0702..
SDHCL 1616 K11 U	■	SDHCR 1616 K11 U	■	16	16	125		16		17.5°	17.5°	DC..11T3..

SDHC... U (107.5°) INCH

Order designation		Dimensions								Inserts
L	R	h	b	l ₁		f		α	β	□ 201...

STANDARD-LINE

SDHCL 3/8" H07 U	■	SDHCR 3/8" H07 U	■	9.525	9.525	100		11		17.5°	17.5°	DC..0702..
SDHCL 1/2" H07 U	■	SDHCR 1/2" H07 U	■	12.7	12.7	100		12.7		17.5°	17.5°	DC..0702..
SDHCL 5/8" K11 U	■	SDHCR 5/8" K11 U	■	15.875	15.875	125		15.875		17.5°	17.5°	DC..11T3..

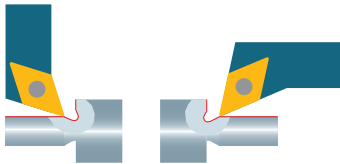

With internal cooling

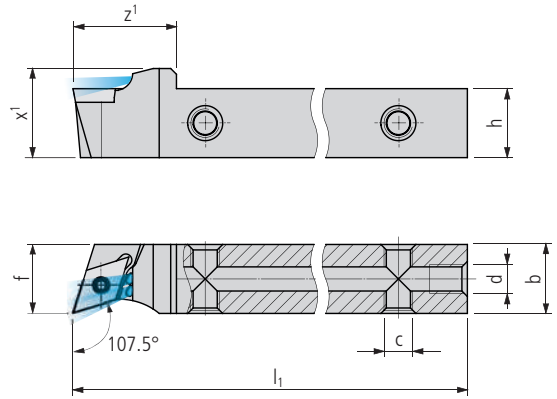
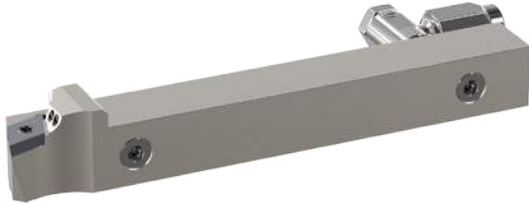

SDHC... U IC (107.5°)

Order designation		Dimensions										Inserts
L	R	h	b	l ₁	z ¹	x ¹	c	d	f	□ 201...		

PREMIUM-LINE

SDHCL 0808 H07 U IC	■	SDHCR 0808 H07 U IC	■	8	8	100	18	11.5	M5	M5	11	DC..0702..
SDHCL 1010 H07 U IC	■	SDHCR 1010 H07 U IC	■	10	10	100	18	13.5	M5	M5	12	DC..0702..
SDHCL 1212 H07 U IC	■	SDHCR 1212 H07 U IC	■	12	12	100	18	15.5	M5	M5	12	DC..0702..
SDHCL 1616 K11 U IC	■	SDHCR 1616 K11 U IC	■	16	16	125	21	19.5	M5	G½"	16	DC..11T3..

SDHC... U IC (107.5°) INCH

Order designation		Dimensions										Inserts
L	R	h	b	l ₁	z ¹	x ¹	c	d	f	□ 201...		

PREMIUM-LINE

SDHCL 3/8" H07 U IC	■	SDHCR 3/8" H07 U IC	■	9.525	9.525	100	18	13	M5	M5	12	DC..0702..
SDHCL 1/2" H07 U IC	■	SDHCR 1/2" H07 U IC	■	12.7	12.7	100	18	16.2	M5	M5	12.7	DC..0702..
SDHCL 5/8" K11 U IC	■	SDHCR 5/8" K11 U IC	■	15.875	15.875	125	21	19.4	M5	G½"	15.875	DC..11T3..

Scope of delivery: Holder without coolant connector
 Coolant system □ 619...

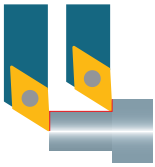

230

UTILIS **multidec**®
swiss type tools

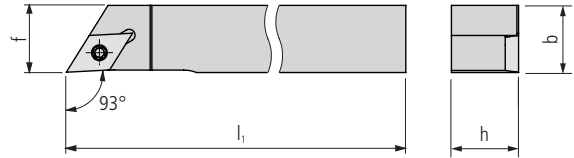

SDJC... U (93°)

Order designation		Dimensions							Inserts
L	R	h	b	l ₁		f		□ 201...	

STANDARD-LINE

SDJCL 0808 F07 U	■	SDJCR 0808 F07 U	■	8	8	80		7.95			DC..0702..
SDJCL 0808 H07 U	■	SDJCR 0808 H07 U	■	8	8	100		7.95			DC..0702..
SDJCL 1010 F07 U	■	SDJCR 1010 F07 U	■	10	10	80		9.95			DC..0702..
SDJCL 1010 H07 U	■	SDJCR 1010 H07 U	■	10	10	100		9.95			DC..0702..
SDJCL 1010 H11 U	■	SDJCR 1010 H11 U	■	10	10	100		11.95			DC..11T3..
SDJCL 1212 H07 U	■	SDJCR 1212 H07 U	■	12	12	100		11.95			DC..0702..
SDJCL 1212 H11 U	■	SDJCR 1212 H11 U	■	12	12	100		11.95			DC..11T3..
SDJCL 1616 K07 U	■	SDJCR 1616 K07 U	■	16	16	125		15.95			DC..0702..
SDJCL 1616 K11 U	■	SDJCR 1616 K11 U	■	16	16	125		15.95			DC..11T3..
SDJCL 2020 K11 U	■	SDJCR 2020 K11 U	■	20	20	125		19.95			DC..11T3..

SDJC... U (93°) INCH

Order designation		Dimensions							Inserts
L	R	h	b	l ₁		f		□ 201...	

STANDARD-LINE

SDJCL 3/8" F07 U	■	SDJCR 3/8" F07 U	■	9.525	9.525	80		9.475			DC..0702..
SDJCL 3/8" H07 U	■	SDJCR 3/8" H07 U	■	9.525	9.525	100		9.475			DC..0702..
SDJCL 3/8" F11 U	■	SDJCR 3/8" F11 U	■	9.525	9.525	80		11.95			DC..11T3..
SDJCL 3/8" H11 U	■	SDJCR 3/8" H11 U	■	9.525	9.525	100		11.95			DC..11T3..
SDJCL 1/2" H07 U	■	SDJCR 1/2" H07 U	■	12.7	12.7	100		12.65			DC..0702..
SDJCL 1/2" H11 U	■	SDJCR 1/2" H11 U	■	12.7	12.7	100		12.65			DC..11T3..
SDJCL 5/8" K11 U	■	SDJCR 5/8" K11 U	■	15.875	15.875	125		15.825			DC..11T3..
SDJCL 3/4" K11 U	■	SDJCR 3/4" K11 U	■	19.05	19.05	125		19			DC..11T3..

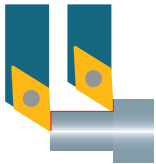

With internal cooling



SDJCL... U IC (93°)

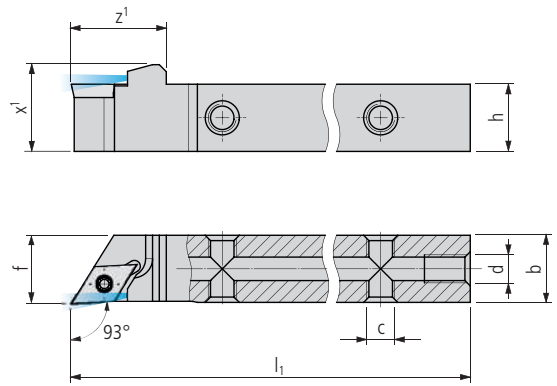

Order designation		Dimensions										Inserts
L	R	h	b	l ₁	z ¹	x ¹	c	d	f	□ 201...		

PREMIUM-LINE

SDJCL 0810 H07 U IC	■	SDJCR 0810 H07 U IC	■	8	10	100	17	11.5	M5	M5	8	DC.. 0702..
SDJCL 1010 H07 U IC	■	SDJCR 1010 H07 U IC	■	10	10	100	17	13.5	M5	M5	10	DC.. 0702..
SDJCL 1010 H11 U IC	■	SDJCR 1010 H11 U IC	■	10	10	100	22	13.5	M5	M5	10	DC.. 11T3..
SDJCL 1212 H07 U IC	■	SDJCR 1212 H07 U IC	■	12	12	100	17	15.5	M5	M5	12	DC.. 0702..
SDJCL 1212 H11 U IC	■	SDJCR 1212 H11 U IC	■	12	12	100	22	15.5	M5	M5	12	DC.. 11T3..
SDJCL 1616 K07 U IC	■	SDJCR 1616 K07 U IC	■	16	16	125	17	15.5	M5	G ¹ / ₈ "	16	DC.. 0702..
SDJCL 1616 K11 U IC	■	SDJCR 1616 K11 U IC	■	16	16	125	22	19.5	M5	G ¹ / ₈ "	16	DC.. 11T3..
SDJCL 2020 K11 U IC	■	SDJCR 2020 K11 U IC	■	20	20	125	22	23.5	M5	G ¹ / ₈ "	20	DC.. 11T3..

SDJCL... U IC (93°) INCH

Order designation		Dimensions										Inserts
L	R	h	b	l ₁	z ¹	x ¹	c	d	f	□ 201...		

PREMIUM-LINE

SDJCL 3/8" H07 U IC	■	SDJCR 3/8" H07 U IC	■	9.525	9.525	100	17	13	M5	M5	9.525	DC.. 0702..
SDJCL 3/8" H11 U IC	■	SDJCR 3/8" H11 U IC	■	9.525	9.525	100	22	13	M5	M5	9.525	DC.. 11T3..
SDJCL 1/2" H07 U IC	■	SDJCR 1/2" H07 U IC	■	12.7	12.7	100	17	16.2	M5	M5	12.7	DC.. 0702..
SDJCL 1/2" H11 U IC	■	SDJCR 1/2" H11 U IC	■	12.7	12.7	100	22	16.2	M5	M5	12.7	DC.. 11T3..
SDJCL 5/8" K07 U IC	■	SDJCR 5/8" K07 U IC	■	15.875	15.875	125	17	19.5	M5	G ¹ / ₈ "	15.875	DC.. 0702..
SDJCL 5/8" K11 U IC	■	SDJCR 5/8" K11 U IC	■	15.875	15.875	125	22	19.5	M5	G ¹ / ₈ "	15.875	DC.. 11T3..
SDJCL 3/4" K11 U IC	■	SDJCR 3/4" K11 U IC	■	19.05	19.05	125	22	22.6	M5	G ¹ / ₈ "	19.05	DC.. 11T3..

Scope of delivery: Holder without coolant connector

Coolant system □ 619...

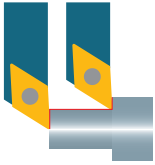

"FC" version (fast change)

232

UTILIS **multidec**®
SWISS type tools

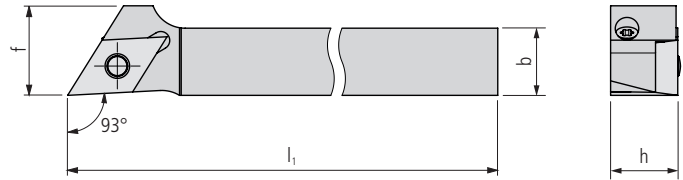
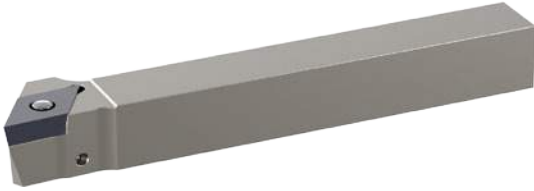

SDJC... U FC* (93°)

Order designation		Dimensions							Inserts
L	R	h	b	l ₁		f		□ 201...	
STANDARD-LINE									
SDJCL 1012 H11 U FC	■	SDJCR 1012 H11 U FC	■	10	12	100		16	DC..11T3..
SDJCL 1212 H11 U FC	■	SDJCR 1212 H11 U FC	■	12	12	100		16	DC..11T3..
SDJCL 1616 K11 U FC	■	SDJCR 1616 K11 U FC	■	16	16	125		16	DC..11T3..

SDJC... U FC* (93°) INCH

Order designation		Dimensions							Inserts
L	R	h	b	l ₁		f		□ 201...	
STANDARD-LINE									
SDJCL 1/2" H11 U FC	■	SDJCR 1/2" H11 U FC	■	12.7	12.7	100		16	DC..11T3..
SDJCL 5/8" K11 U FC	■	SDJCR 5/8" K11 U FC	■	15.875	15.875	125		15.875	DC..11T3..

Spare parts (clamping bolts /screws) □ 247

* Note

With this holder, the indexable insert is secured with a screw using a knee lever that can be operated from behind. This means the holder does not have to be unclamped to change the cutting edge.
 Tighten the clamping screw to 1.2 Nm using a torque screwdriver.

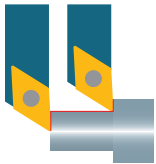

"FC" version (fast change) with internal cooling

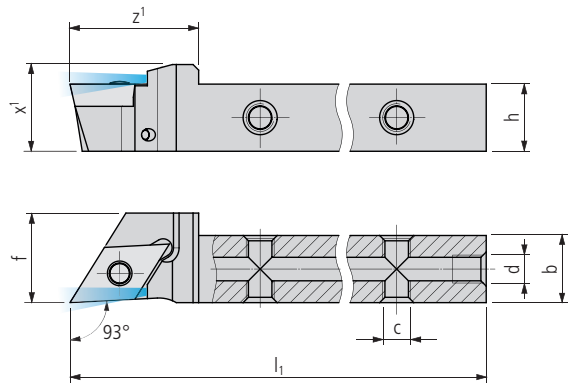

SDJC... U FC* IC (93°)

Order designation		Dimensions										Inserts
L	R	h	b	l ₁	z ₁	x ₁	c	d	f	□ 201...		

PREMIUM-LINE

SDJCL 1012 H11 U FC IC	■	SDJCR 1012 H11 U FC IC	■	10	12	100	23	13.5	M5	M5	16	DC..11T3..
SDJCL 1212 H11 U FC IC	■	SDJCR 1212 H11 U FC IC	■	12	12	100	23	15.5	M5	M5	16	DC..11T3..
SDJCL 1616 K11 U FC IC	■	SDJCR 1616 K11 U FC IC	■	16	16	125	23	19.5	M5	G½"	16	DC..11T3..

SDJC... U FC* IC (93°) INCH

Order designation		Dimensions										Inserts
L	R	h	b	l ₁	z ₁	x ₁	c	d	f	□ 201...		

PREMIUM-LINE

SDJCL 1/2" H11 U FC IC	■	SDJCR 1/2" H11 U FC IC	■	12.7	12.7	100	23	16.2	M5	M5	16	DC..11T3..
SDJCL 5/8" K11 U FC IC	■	SDJCR 5/8" K11 U FC IC	■	15.875	15.875	125	23	19.4	M5	G½"	15.875	DC..11T3..

Spare parts (clamping bolts/screws) □ 247

* Note

With this holder, the indexable insert is secured with a screw using a knee lever that can be operated from behind. This means the holder does not have to be unclamped to change the cutting edge.
 Tighten the clamping screw to 1.2 Nm using a torque screwdriver.

Scope of delivery: Holder without coolant connector

Coolant system □ 619...

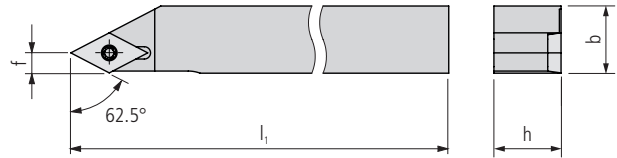
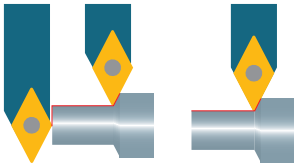

SDNC... U (62.5°)

Order designation		Dimensions							Inserts
L	R	h	b	l ₁		f		□ 201...	

STANDARD-LINE

SDNCL 0808 F07 U	■	SDNCR 0808 F07 U	■	8	8	80		3.63				DC..0702..
SDNCL 0808 H07 U	■	SDNCR 0808 H07 U	■	8	8	100		3.63				DC..0702..
SDNCL 1010 F07 U	■	SDNCR 1010 F07 U	■	10	10	80		3.63				DC..0702..
SDNCL 1010 H07 U	■	SDNCR 1010 H07 U	■	10	10	100		3.63				DC..0702..
SDNCL 1212 H07 U	■	SDNCR 1212 H07 U	■	12	12	100		3.63				DC..0702..
SDNCL 1212 H11 U	■	SDNCR 1212 H11 U	■	12	12	100		5.42				DC..11T3..
SDNCL 1616 K11 U	■	SDNCR 1616 K11 U	■	16	16	125		5.42				DC..11T3..
SDNCL 2020 K11 U	■	SDNCR 2020 K11 U	■	20	20	125		5.42				DC..11T3..

SDNC... U (62.5°) INCH

Order designation		Dimensions							Inserts
L	R	h	b	l ₁		f		□ 201...	

STANDARD-LINE

SDNCL 3/8" H07 U	■	SDNCR 3/8" H07 U	■	9.525	9.525	100		3.63				DC..0702..
SDNCL 1/2" H07 U	■	SDNCR 1/2" H07 U	■	12.7	12.7	100		3.63				DC..0702..
SDNCL 1/2" H11 U	■	SDNCR 1/2" H11 U	■	12.7	12.7	100		5.42				DC..11T3..
SDNCL 5/8" K11 U	■	SDNCR 5/8" K11 U	■	15.875	15.875	125		5.42				DC..11T3..

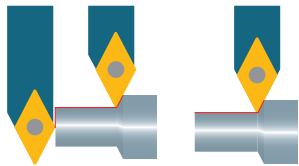

With internal cooling

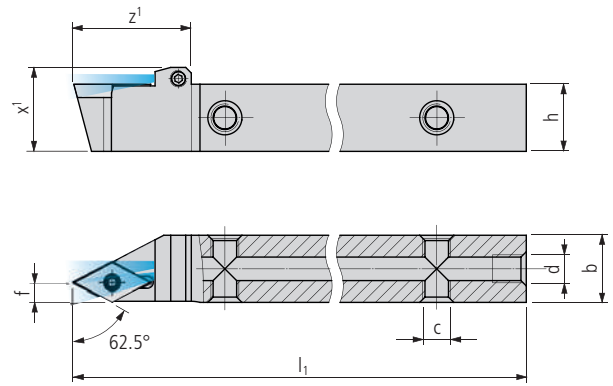

SDNC... U IC (62.5°)

Order designation		Dimensions									Inserts
L	R	h	b	l ₁	z ₁	x ₁	c	d	f	□ 201...	

PREMIUM-LINE

SDNCL 1010 H07 U IC	■	SDNCR 1010 H07 U IC	■	10	10	100	21	13	M5	M5	3.63	DC..0702..
SDNCL 1212 H07 U IC	■	SDNCR 1212 H07 U IC	■	12	12	100	21	15	M5	M5	3.63	DC..0702..
SDNCL 1212 H11 U IC	■	SDNCR 1212 H11 U IC	■	12	12	100	25	15.5	M5	M5	5.42	DC..11T3..
SDNCL 1616 K11 U IC	■	SDNCR 1616 K11 U IC	■	16	16	125	25	19.5	M5	G½"	5.42	DC..11T3..

SDNC... U IC (62.5°) INCH

Order designation		Dimensions									Inserts
L	R	h	b	l ₁	z ₁	x ₁	c	d	f	□ 201...	

PREMIUM-LINE

SDNCL 3/8" H07 U IC	■	SDNCR 3/8" H07 U IC	■	9.525	9.525	100	21	12.5	M5	M5	3.63	DC..0702..
SDNCL 1/2" H07 U IC	■	SDNCR 1/2" H07 U IC	■	12.7	12.7	100	21	15.7	M5	M5	3.63	DC..0702..
SDNCL 1/2" H11 U IC	■	SDNCR 1/2" H11 U IC	■	12.7	12.7	100	25	16.2	M5	M5	5.42	DC..11T3..
SDNCL 5/8" K11 U IC	■	SDNCR 5/8" K11 U IC	■	15.875	15.875	125	25	19.4	M5	G½"	5.42	DC..11T3..

Scope of delivery: Holder without coolant connector
 Coolant system 619...



236

UTILIS **multidec**®
swiss type tools

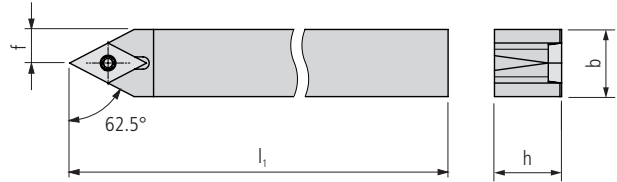

SDNCN ... U (62.5°)

Order designation		Dimensions							Inserts
N		h	b	l ₁		f		□ 201...	

STANDARD-LINE

SDNCN 0808 F07 U	■		8	8	80		4		DC..0702..
SDNCN 0808 K07 U	■		8	8	125		4		DC..0702..
SDNCN 1010 E07 U	■		10	10	70		5		DC..0702..
SDNCN 1010 M07 U	■		10	10	150		5		DC..0702..
SDNCN 1212 F07 U	■		12	12	80		6		DC..0702..
SDNCN 1212 M07 U	■		12	12	150		6		DC..0702..
SDNCN 1212 M11 U	■		12	12	150		6		DC..11T3..
SDNCN 1616 H11 U	■		16	16	100		8		DC..11T3..
SDNCN 2020 K11 U	■		20	20	125		10		DC..11T3..

SDNCN ... U (62.5°) INCH

Order designation		Dimensions							Inserts
N		h	b	l ₁		f		□ 201...	

STANDARD-LINE

SDNCN 3/8"H07 U	■		9.525	9.525	100		4.76		DC..0702..
SDNCN 1/2"H07 U	■		12.7	12.7	100		6.35		DC..0702..
SDNCN 1/2"H11 U	■		12.7	12.7	100		6.35		DC..11T3..
SDNCN 5/8"H11 U	■		15.875	15.875	125		7.94		DC..11T3..



With internal cooling

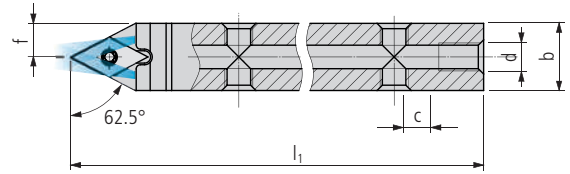
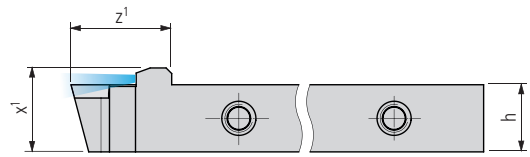

SDNCN ... U IC (62.5°)

Order designation		Dimensions										Inserts
N		h	b	l ₁	z ₁	x ₁	c	d	f	□ 201...		

PREMIUM-LINE

SDNCN 0808 H07 U IC	■	8	8	100	18	11	M5	M5	4	DC..0702..	
SDNCN 1010 H07 U IC	■	10	10	100	18	13	M5	M5	5	DC..0702..	
SDNCN 1212 H07 U IC	■	12	12	100	18	15	M5	M5	6	DC..0702..	
SDNCN 1616 K11 U IC	■	16	16	125	22	19	M5	G½"	8	DC..11T3..	

SDNCN ... U IC (62.5°) INCH

Order designation		Dimensions										Inserts
N		h	b	l ₁	z ₁	x ₁	c	d	f	□ 201...		

PREMIUM-LINE

SDNCN 3/8" H07 U IC	■	9.525	9.525	100	18	13	M5	M5	4.76	DC..0702..	
SDNCN 1/2" H07 U IC	■	12.7	12.7	100	18	15.7	M5	M5	6.35	DC..0702..	
SDNCN 1/2" H11 U IC	■	12.7	12.7	100	24	15.7	M5	M5	6.35	DC..11T3..	
SDNCN 5/8" K11 U IC	■	15.875	15.875	125	24	18.9	M5	G½"	7.94	DC..11T3..	

Scope of delivery: Holder without coolant connector
 Coolant system □ 619...



"TWIN" version

238

UTILIS **multidec**®
 SWISS type tools

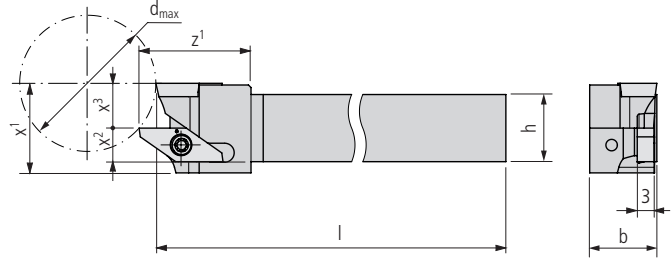

SDJC. (93°)/1600... TWIN

Order designation	Dimensions									Inserts	
	h	b	l	z ¹	x ¹	x ²	x ³	d _{max}	□201...	□49...	
											

STANDARD-LINE

	SDJCR/1600R-0810 H07 Twin	■	8	10	100	20	16	4	8	23	DC..0702..	16...
	SDJCR/1600R-1010 H07 Twin	■	10	10	100	20	16	5	8	23	DC..0702..	16...
	SDJCR/1600R-1212 H07 Twin	■	12	12	100	20	16	6	8	23	DC..0702..	16...
	SDJCR/1600R-1616 K11 Twin	■	16	16	125	20	20	8	10	35	DC..11T3..	16...
	SDJCR/1600R-2020 K11 Twin	■	20	20	125	20	24	8	14	68	DC..11T3..	16...

SDJC. (93°)/1600... TWIN INCH

Order designation	Dimensions									Inserts	
	h	b	l	z ¹	x ¹	x ²	x ³	d _{max}	□201...	□49...	
											

STANDARD-LINE

	SDJCR/1600R-3/8" H07 Twin	■	9.525	9.525	100	20	16	4.76	8	23	DC..0702..	16...
	SDJCR/1600R-1/2" H07 Twin	■	12.7	12.7	100	20	16	6.35	8	23	DC..0702..	16...
	SDJCR/1600R-5/8" K11 Twin	■	15.875	15.875	125	20	20	7.94	10	35	DC..11T3..	16...
	SDJCR/1600R-3/4" K11 Twin	■	19.05	19.05	125	20	24	7.53	14	68	DC..11T3..	16...



"TWIN" version with internal cooling

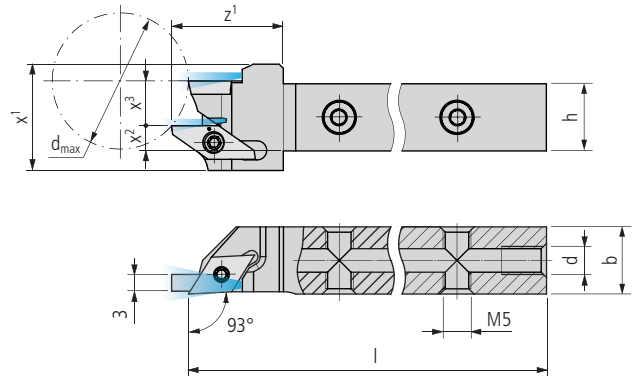

SDJC. (93°)/1600... TWIN IC

Order designation	Dimensions									Inserts	
	h	b	l	z ¹	x ¹	x ²	x ³	d	d _{max}	□ 201...	□ 49...

PREMIUM-LINE

	SDJCR/1600R-0810 H07 Twin IC	■	8	10	100	20	19	2.5	8	M5	23	DC..0702..	16...
	SDJCR/1600R-1010 H07 Twin IC	■	10	10	100	20	19	3.5	8	M5	23	DC..0702..	16...
	SDJCR/1600R-1212 H07 Twin IC	■	12	12	100	20	19	4.5	8	M5	23	DC..0702..	16...
	SDJCR/1600R-1616 K11 Twin IC	■	16	16	125	26	23	6.5	10	G½"	35	DC..11T3..	16...
	SDJCR/1600R-2020 K11 Twin IC	■	20	20	125	26	27	6.5	14	G½"	68	DC..11T3..	16...

SDJC. (93°)/1600... TWIN IC INCH

Order designation	Dimensions									Inserts	
	h	b	l	z ¹	x ¹	x ²	x ³	d	d _{max}	□ 201...	□ 49...

PREMIUM-LINE

	SDJCR/1600R-3/8" H07 Twin IC	■	9.525	9.525	100	20	19	3.26	8	M5	23	DC..0702..	16...
	SDJCR/1600R-1/2" H07 Twin IC	■	12.7	12.7	100	20	19	4.85	8	M5	23	DC..0702..	16...
	SDJCR/1600R-5/8" K11 Twin IC	■	15.875	15.875	125	26	23	6.44	10	G½"	35	DC..11T3..	16...
	SDJCR/1600R-3/4" K11 Twin IC	■	19.05	19.05	125	26	27	5.53	14	G½"	68	DC..11T3..	16...

Scope of delivery: Holder without coolant connector

Coolant system 619...

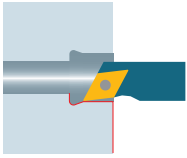

240

UTILIS
 multidec®
 SWISS type tools

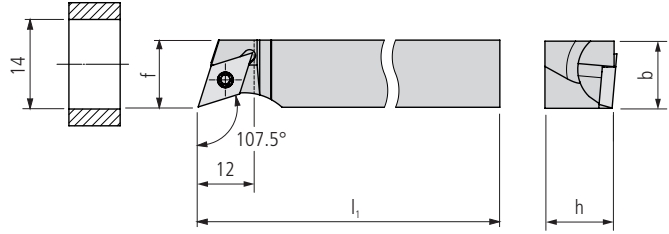

SDHC... (107.5°)

Order designation		Dimensions								Inserts
L	R	h	b	l ₁	f					□ 201...

STANDARD-LINE

SDHCL 1010 XH07	□	SDHCR 1010 XH07	□	10	10	100	11				DC..0702..
SDHCL 1212 XH07	■	SDHCR 1212 XH07	■	12	12	100	12				DC..0702..
SDHCL 1616 XK07	■	SDHCR 1616 XK07	■	16	16	125	13.5				DC..0702..

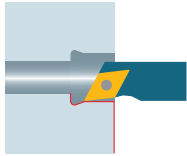

With internal cooling

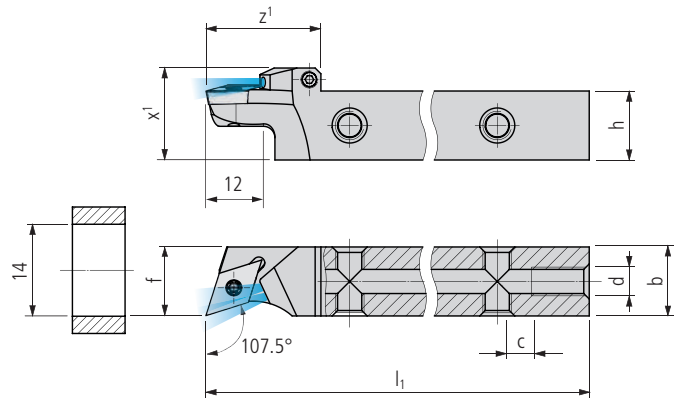

SDHC... IC (107.5°)

Order designation		Dimensions									Inserts
L	R	h	b	l ₁	z ₁	x ₁	c	d	f	□ 201...	

PREMIUM-LINE

SDHCL 1010 XH07 IC	□	SDHCR 1010 XH07 IC	□	10	10	100	20	14	M5	M5	11	DC..0702..
SDHCL 1212 XH07 IC	■	SDHCR 1212 XH07 IC	■	12	12	100	20	16	M5	M5	12	DC..0702..
SDHCL 1616 XK07 IC	■	SDHCR 1616 XK07 IC	■	16	16	125	20	20	M5	G ¹ / ₈ "	13.5	DC..0702..



242

UTILIS **multidec**®
swiss type tools

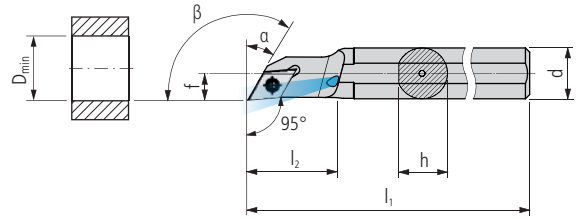

A... SDOC... (95°)

Order designation		Dimensions								Inserts		
L	R	d	h	l ₁	l ₂	f	D _{min}	α	β	□ 201...		
STANDARD-LINE												
A12K SDOCL 07	■	A12K SDOCR 07	■	12	11.5	125	21	7	14	30°	120°	DC..0702..

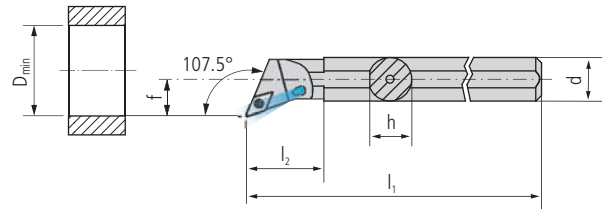

A... SDQC... (107.5°)

Order designation		Dimensions							Inserts
L	R	d	h	l ₁	l ₂	f	D _{min}	□ 201...	
STANDARD-LINE									
A12K SDQCL 07	■ A12K SDQCR 07	12	11.5	125	22	9	16	DC..0702..	
A16M SDQCL 07	■ A16M SDQCR 07	16	15	150	29	11	20	DC..0702..	
A20Q SDQCL 07	■ A20Q SDQCR 07	20	18.5	180	32	13	25	DC..0702..	

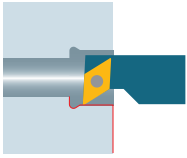

244

UTILIS **multidec**®
swiss type tools

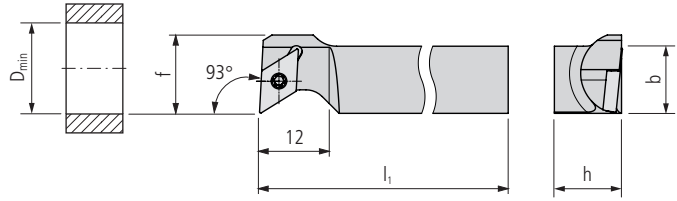

SDUC... (93°)

Order designation		Dimensions							Inserts
L	R	h	b	l ₁	f	D _{min}		□ 201...	

STANDARD-LINE

SDUCL 1010 XH07	□	SDUCR 1010 XH07	□	10	10	100		14	16		DC..0702..
SDUCL 1212 XH07	■	SDUCR 1212 XH07	■	12	12	100		14	16		DC..0702..
SDUCL 1616 XK07	■	SDUCR 1616 XK07	■	16	16	125		14	16		DC..0702..

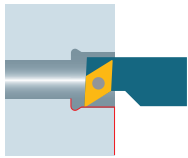

With internal cooling

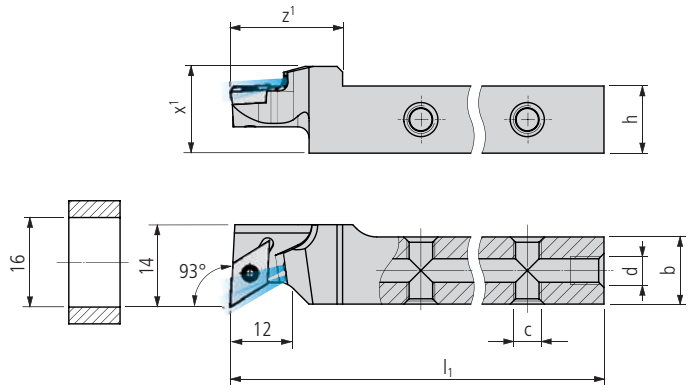

SDUC... IC (93°)

Order designation		Dimensions								Inserts
L	R	h	b	l ₁	z ¹	x ¹	c	d	□ 201...	

PREMIUM-LINE

SDUCL 1010 XH07 IC	□	SDUCR 1010 XH07 IC	□	10	10	100	20	13.5	M5	M5	DC.. 0702..
SDUCL 1212 XH07 IC	■	SDUCR 1212 XH07 IC	■	12	12	100	20	15.5	M5	M5	DC.. 0702..
SDUCL 1616 XH07 IC	□	SDUCR 1616 XH07 IC	□	16	16	100	20	19.5	M5	G ¹ / ₈ "	DC.. 0702..
SDUCL 1616 XK07 IC	■	SDUCR 1616 XK07 IC	■	16	16	125	20	19.5	M5	G ¹ / ₈ "	DC.. 0702..

Scope of delivery: Holder without coolant connector
 Coolant system □ 619...

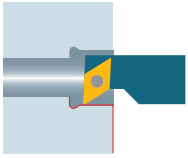

246

UTILIS **multidec**®
swiss type tools

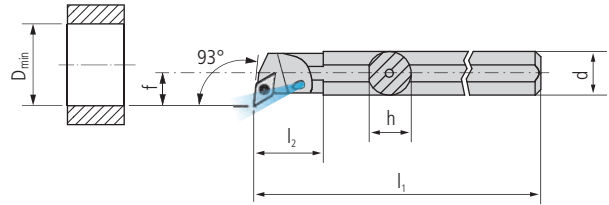

A... SDUC... (93°)

Order designation		Dimensions							Inserts
L	R	d	h	l ₁	l ₂	f	D _{min}	□ 201...	



STANDARD-LINE

A10H SDUCL 07	■	A10H SDUCR 07	■	10	9	100	–	7	14		DC..0702..
A12K SDUCL 07	■	A12K SDUCR 07	■	12	11.5	125	22	9	16		DC..0702..
A16M SDUCL 07	■	A16M SDUCR 07	■	16	15	150	29	11	20		DC..0702..
A20Q SDUCL 07	■	A20Q SDUCR 07	■	20	18.5	180	32	13	25		DC..0702..
A20Q SDUCL 11	■	A20Q SDUCR 11	■	20	18.5	180	32	13	25		DC..11T3..

For holders (SS...) OD turning

Illustration	Description	Dimensions	Order designation	Holder
	TORX screw	M2.5 × 6 T08	MSP 25060 T08	■ SD... 07
		M3.5 × 8.6 T15	MSP 35086 T15	■ SD... 11... Twin
		M3.5 × 11 T15	MSP 35110 T15	■ SD... 11

For holders (SD.C... FC) OD turning

Illustration	Description	Dimensions	Order designation	Holder
	Clamping bolts	4 × 11	MSP SB 40110 FC	■ SD.C... 11 FC
	Clamping screw	M4 × 11	MSP KS 40110 FC T08	■ SD.C... 11 FC

For holders (... SD...) ID turning

Illustration	Description	Dimensions	Order designation	Holder
	TORX screw	M2.5 × 5.5 T07	MSP 25055 T07	■ A10H SD... 07
		M2.5 × 6 T08	MSP 25060 T08	■ A12K SD... 07 A16M SD... 07 A20Q SD... 07
		M3.5 × 8.6 T15	MSP 35086 T15	■ A20Q SD... 11

TORX screwdriver 651...

This further development of multidec®-ISO provides a tool system with 4 cutting edges and the finest performance-cost ratio for Swiss type machining and precision turning. The insert consist of 4 sharp cutting edges with radius 0.08 and 0.15 mm and is easily indexed or changed. Innovative chip breakers have been designed for cutting of very difficult materials on finishing and micro-finishing applications using coated and uncoated submicrograin carbide. Even for the hardened and nickel-plated holders a wide range of possibilities with shank sizes between 10 and 25 mm are available. For Swiss type automatic lathes special holders have been designed and complete the range of choices.

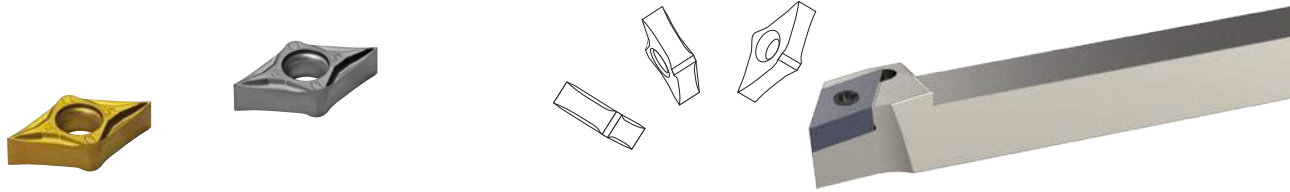

Specific features of insert DNGU:

- Negative holder fixed with screw
- 4 positive cutting edges for the price of 2
- Sharp edges with 7° clearance angle
- Small corner radius (0.08 and 0.15 mm)
- Fine grain grade carbide
- Insert DNGU also usable on holders with toggle setting device







"IC" tool holder with integrated cooling

Cost-efficient processing of modern materials increasingly requires accurate control of the coolant at the cutting edge. Conveying the coolant as close as possible to the cutting edge is often a difficult task in the machine rooms of Swiss type turning lathes. The multidec®-IC program offers a wide range of holders with integrated cooling. Because of the high precision and pressure, it is possible to discharge the chip quickly and safely from the cutting edge and the workpiece, which protects the cutting edge of the insert. This means significantly longer tool life as well as very reliable serial production.

Advantages:

- All holders feature five possible connectors for the coolant supply
- Constant coolant discharge means low build-up at front near the holder
- With or without high pressure, the coolant medium always hits the cutting edge precisely

Overview – multidec®-ISO, type DN... (55°)

Technical information		11
Inserts (carbide / cermet)		
DNGU ...		250
Holder (OD turning)		
SDJN... (93°), SDJN... IC (93°)		252
SDNNN ... (62.5°), SDNNN ... IC (62.5°)		254
Replacement and spare parts		256
Coolant system and accessories		619

250

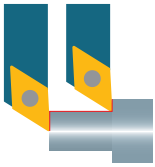

UTILIS
multidec
swiss type tools

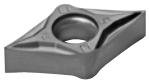

DNGU ... -A4

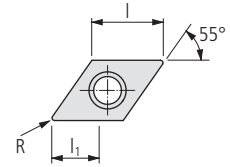

Order designation	Carbide												Cermet		Diamond		Dimensions			Holder			
	UHM 10	UHM 10 HX	UHM 10 TX+	UHM 10 MZ	UHM 20	UHM 20 HPX	UHM 20 TX+	UHM 20 MZ	UHM 30	UHM 30 HX	UHM 30 TX+	UHM 30 MZ	UHM 30 SX	UCM 10	UCM 10 HX	UCM 10 MZ	UCVD 08	UPCD 15	UPCD 20	L	R	L ₁	□ 252...
	-	-	●	●	○	●	●	●	○	●	●	○	●	●	●	-	-	-	-				
	○	●	●	-	-	○	○	○	○	○	○	○	○	○	○	○	-	-	-				
	●	○	-	-	-	-	-	-	-	-	-	-	-	-	-	-	●	●	●				
	-	-	●	-	-	-	-	-	-	-	-	-	-	-	-	-	-	-	-				

STANDARD-LINE

N	Order designation	Carbide												Cermet		Diamond		Dimensions			Holder		
		UHM 10	UHM 10 HX	UHM 10 TX+	UHM 10 MZ	UHM 20	UHM 20 HPX	UHM 20 TX+	UHM 20 MZ	UHM 30	UHM 30 HX	UHM 30 TX+	UHM 30 MZ	UHM 30 SX	UCM 10	UCM 10 HX	UCM 10 MZ	UCVD 08	UPCD 15	UPCD 20	L	R	L ₁
	DNGU 1104008 FN -A4 ...					■	■	■		■	■									11.6	0.08	2.9	SDJN...11
	DNGU 1104015 FN -A4 ...					■	■	■		■	■									11.6	0.15	2.9	SDJN...11
	DNGU 1104035 FN -A4 ...					■	■	■		■	■									11.6	0.35	2.9	SDJN...11

Application range of chip breaker

Properties:

- polished rake and ground clearance
- 4 sharp cutting edge "F"
- submicrograin carbide, high toughness
- best performance-cost ratio

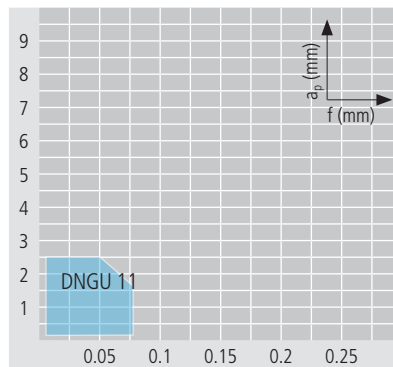

Optimal chip breaking

Application:

- micro finishing
- chip breaker for general application
- alloyed steel and stainless steel

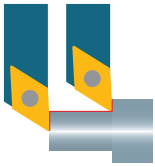

252

UTILIS
 multidec®
 swiss type tools

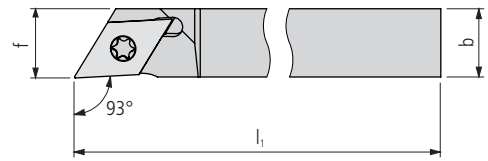
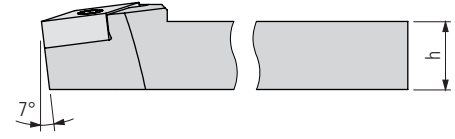

SDJN... (93°)

Order designation		Dimensions								Inserts
L	R	h	b	l ₁	f					□ 250...

STANDARD-LINE

SDJNL 1012 F11	■	SDJNR 1012 F11	■	10	12	80	12			DN... 11...
SDJNL 1012 H11	■	SDJNR 1012 H11	■	10	12	100	12			DN... 11...
SDJNL 1212 H11	■	SDJNR 1212 H11	■	12	12	100	12			DN... 11...
SDJNL 1616 K11	■	SDJNR 1616 K11	■	16	16	125	16			DN... 11...
SDJNL 2020 K11	■	SDJNR 2020 K11	■	20	20	125	20			DN... 11...
SDJNL 2525 M11	■	SDJNR 2525 M11	■	25	25	150	25			DN... 11...

SDJN... (93°) INCH

Order designation		Dimensions								Inserts
L	R	h	b	l ₁	f					□ 250...

STANDARD-LINE

SDJNL 3/8" F11	■	SDJNR 3/8" F11	■	9.525	9.525	80	9.525			DN... 11...
SDJNL 3/8" H11	■	SDJNR 3/8" H11	■	9.525	9.525	100	9.525			DN... 11...
SDJNL 1/2" H11	■	SDJNR 1/2" H11	■	12.7	12.7	100	12.7			DN... 11...
SDJNL 5/8" K11	■	SDJNR 5/8" K11	■	15.875	15.875	125	15.875			DN... 11...
SDJNL 3/4" K11	■	SDJNR 3/4" K11	■	19.05	19.05	125	19.05			DN... 11...

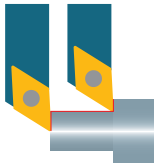

With internal cooling



SDJN... IC (93°)

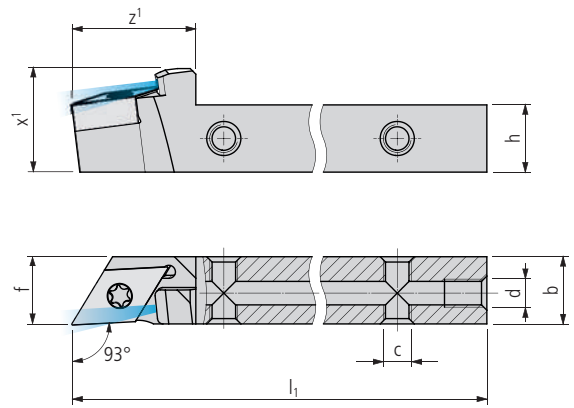

Order designation		Dimensions										Inserts
L	R	h	b	l ₁	z ¹	x ¹	c	d	f	□ 250...		

PREMIUM-LINE

SDJNL 0808 H11 IC	■	SDJNR 0808 H11 IC	■	8	8	100	22	16.5	M5	M5	8	DN.. 11...
SDJNL 1012 H11 IC	■	SDJNR 1012 H11 IC	■	10	12	100	22	16.5	M5	M5	12	DN.. 11...
SDJNL 1212 H11 IC	■	SDJNR 1212 H11 IC	■	12	12	100	22	18.5	M5	M5	12	DN.. 11...
SDJNL 1616 K11 IC	■	SDJNR 1616 K11 IC	■	16	16	125	22	22.5	M5	G ¹ / ₈ "	16	DN.. 11...
SDJNL 2020 K11 IC	■	SDJNR 2020 K11 IC	■	20	20	125	22	26.5	M5	G ¹ / ₈ "	20	DN.. 11...
SDJNL 2525 K11 IC	■	SDJNR 2525 K11 IC	■	25	25	125	22	31.5	M5	G ¹ / ₈ "	25	DN.. 11...

SDJN... IC (93°) INCH

Order designation		Dimensions										Inserts
L	R	h	b	l ₁	z ¹	x ¹	c	d	f	□ 250...		

PREMIUM-LINE

SDJNL 3/8" H11 IC	■	SDJNR 3/8" H11 IC	■	9.525	12	100	22	16	M5	M5	12	DN.. 11...
SDJNL 1/2" H11 IC	■	SDJNR 1/2" H11 IC	■	12.7	12.7	100	22	19.2	M5	M5	12.7	DN.. 11...
SDJNL 5/8" K11 IC	■	SDJNR 5/8" K11 IC	■	15.875	15.875	125	22	22.4	M5	G ¹ / ₈ "	15.875	DN.. 11...
SDJNL 3/4" K11 IC	■	SDJNR 3/4" K11 IC	■	19.05	19.05	125	22	25.5	M5	G ¹ / ₈ "	19.05	DN.. 11...

Scope of delivery: Holder without coolant connector
 Coolant system □ 619...



254

UTILIS
 multidec®
 SWISS type tools

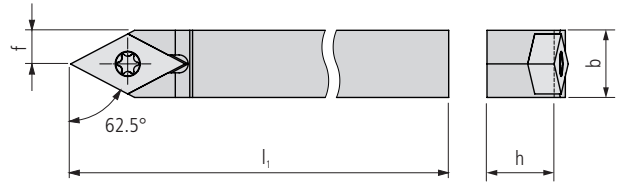

SDNNN ... (62.5°)

Order designation		Dimensions							Inserts
N		h	b	l ₁	f				□ 250...

STANDARD-LINE

SDNNN 1012 H11	■			10	12	100		6			DN..11..
SDNNN 1212 H11	■			12	12	100		6			DN..11..
SDNNN 1616 K11	■			16	16	125		8			DN..11..
SDNNN 2020 K11	■			20	20	125		10			DN..11..
SDNNN 2525 K11	■			25	25	125		12.5			DN..11..

SDNNN ... (62.5°) INCH

Order designation		Dimensions							Inserts
N		h	b	l ₁	f				□ 250...

STANDARD-LINE

SDNNN 3/8" H11	■			9.525	9.525	100		4.76			DN..11..
SDNNN 1/2" H11	■			12.7	12.7	100		6.35			DN..11..
SDNNN 5/8" K11	■			15.875	15.875	125		7.94			DN..11..
SDNNN 3/4" K11	■			19.05	19.05	125		9.525			DN..11..



With internal cooling

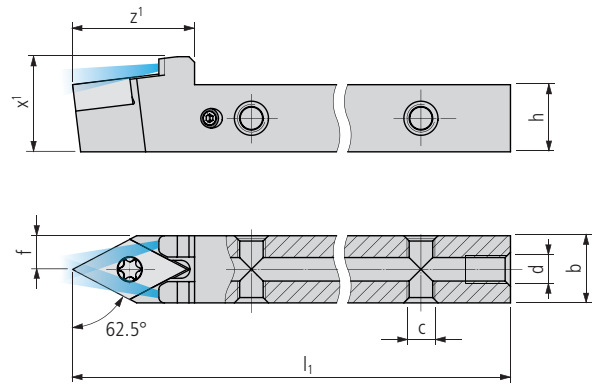

SDNNN ... IC (62.5°)

Order designation		Dimensions										Inserts
N		h	b	l ₁	z ¹	x ¹	c	d	f	□ 250...		

PREMIUM-LINE

SDNNN 1012 H11 IC	■			10	12	100	22	15	M5	M5	6	DN..11..
SDNNN 1212 H11 IC	■			12	12	100	22	17	M5	M5	6	DN..11..
SDNNN 1616 K11 IC	■			16	16	125	22	21	M5	G ¹ / ₈ "	8	DN..11..
SDNNN 2020 K11 IC	■			20	20	125	22	25	M5	G ¹ / ₈ "	10	DN..11..
SDNNN 2525 K11 IC	■			25	25	125	25	30.5	M5	G ¹ / ₈ "	12.5	DN..11..

SDNNN ... IC (62.5°) INCH

Order designation		Dimensions										Inserts
N		h	b	l ₁	z ¹	x ¹	c	d	f	□ 250...		

PREMIUM-LINE

SDNNN 3/8" H11 IC	■			9.525	9.525	100	22	14.525	M5	M5	4.76	DN..11..
SDNNN 1/2" H11 IC	■			12.7	12.7	100	22	17.7	M5	M5	6.35	DN..11..
SDNNN 5/8" K11 IC	■			15.875	15.875	125	22	20.875	M5	G ¹ / ₈ "	7.94	DN..11..
SDNNN 3/4" K11 IC	■			19.05	19.05	125	22	24.05	M5	G ¹ / ₈ "	9.525	DN..11..

Scope of delivery: Holder without coolant connector

Coolant system □ 619...

For holders (SD.N...) OD turning

Illustration	Description	Dimensions	Order designation	Holder
	TORX screw	M4 x 11 TP15	MSP 40110 TP15	■ SDJN. 11

256

TORX screwdriver 651...

multidec®-ISO provides a well balanced range of tools for turning with rhombic 35° inserts and holders. Positive inserts with rounded cutting edges for roughing and sharp cutting edges for finishing are available.

These include a wide range of ground holders with hardened and nickel-plated surfaces for Swiss type automatic lathes with shank sizes from 8 to 20 mm and boring bars with diameters from 12 to 20 mm.



Advantages:

- Carbide and Cermet grades with chip breaker and coatings for all common materials
- Diamond range with CVD and PCD inserts for machining non-ferrous metals
- Cutting edge radius from 0.05 to 0.8 mm as standard
- Boring bars with steel- and carbide shanks



"IC" tool holder with integrated cooling

Cost-efficient processing of modern materials increasingly requires accurate control of the coolant at the cutting edge. Conveying the coolant as close as possible to the cutting edge is often a difficult task in the machine rooms of Swiss type turning lathes.

The multidec®-IC program offers a wide range of holders with integrated cooling. Because of the high precision and pressure, it is possible to discharge the chip quickly and safely from the cutting edge and the workpiece, which protects the cutting edge of the insert. This means significantly longer tool life as well as very reliable serial production.

Advantages:

- All holders feature five possible connectors for the coolant supply
- Constant coolant discharge means low build-up at front near the holder
- With or without high pressure, the coolant medium always hits the cutting edge precisely



"TWIN" holder with and without integrated coolant supply

The "TWIN" range allows you to work with two inserts on the same holder. Different combinations are possible, and provide the user with a high degree of flexibility. Holders are available with shank cross-sections of 8 to 20 mm, with and without internal cooling.

Advantages:

- Twice the number of tools on the machine
- Two different turning operations are possible with a single tool holder
- All holders with an integrated coolant supply have five connecting options

Inserts (carbide / cermet)



VCGT ... FN -A3, VCGT ... EN -A3	260
VCGT ... -PA5	262
VCGT ... -TOP5	263
VCGT ... -PA7	264
VCXT ... -PA9	265
VCGT ... -PF	266
VCMT ... -PF	267
VCET ... -PF05	268
VCGT ... FN -PF23, VCGT ... EN -PF23	269
VCGT ... FN -PF33, VCGT ... EN -PF33	271
VCMT ... -PF43	273
VCMT ... -PM	274
VCMT ... -PMF	275
VCMT ... -PM25	276
VCMT ... -PM55	277

Inserts (diamond)



VCGT ...	278
VCGT ... -UWS, VCGT ... -UWN	279
VCGW ...	281

Holder (OD turning)



SVAC... U (90°)	283
SVJC... U (93°), SVJC... U IC (93°)	284
SVHC... U (107.5°), SVHC... U IC (107.5°)	286
SVPC... U (117.5°), SVPC... U IC (117.5°)	288
SVQC... (93°)	290
SVUC... (93°)	291
SVVCN ... U (72.5°), SVVCN ... U IC (72.5°)	292
SVXC... U (91°), SVXC... U IC (91°)	294
SVJC. (93°)/1600... TWIN, SVJC. (93°)/1600... IC TWIN	296

Holder (ID turning)

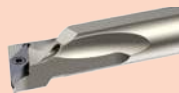

A... SVQC... (107.5°)	298
A... SVOC... (95°)	299
A... SVUC... (93°)	300

Replacement and spare parts



	301
--	-----

Coolant system and accessories



	619
--	-----

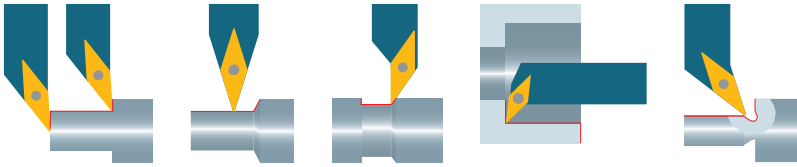

260

UTILIS
multidec
swiss type tools



VCGT ... FN -A3

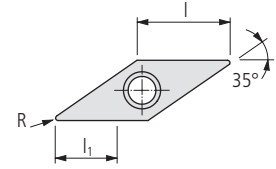

Order designation	Carbide												Cermet		Diamond		Dimensions			Holder			
	UHM 10	UHM 10 HX	UHM 10 TX+	UHM 10 MZ	UHM 20	UHM 20 HPX	UHM 20 TX+	UHM 20 MZ	UHM 30	UHM 30 HX	UHM 30 TX+	UHM 30 MZ	UHM 30 SX	UCM 10	UCM 10 HX	UCM 10 MZ	UCVD 08	UPCD 15	UPCD 20	l	R	l ₁	□ 283...
	-	-	●	●	○	●	●	●	○	●	●	○	○	●	●	○	-	-	-	6.8	0.06	3	SV...07...
	○	●	●	-	-	○	○	○	○	○	○	○	○	○	○	○	-	-	-	6.8	0.1	3	SV...07...
	○	○	-	-	-	-	-	-	-	-	-	-	-	-	-	-	-	-	6.8	0.15	3	SV...07...	
	●	○	-	-	-	○	○	-	-	-	-	-	-	-	-	-	●	●	11.1	0.08	6	SV...11...	
	-	○	●	-	-	-	-	-	-	-	-	-	-	-	-	-	-	-	11.1	0.15	6	SV...11...	
	-	-	-	-	-	-	-	-	-	-	-	-	-	-	-	-	-	-	11.1	0.35	6	SV...11...	

STANDARD-LINE

	VCGT 0702006 FN -A3 ...	VCGT 070201 FN -A3	VCGT 0702015 FN -A3	VCGT 1103008 FN -A3 ...	VCGT 1103015 FN -A3 ...	VCGT 1103035 FN -A3 ...																	
N	■	■	■																	6.8	0.06	3	SV...07...
	■	■	■																	6.8	0.1	3	SV...07...
	■	■	■																	6.8	0.15	3	SV...07...
	■	■	■	■	■	■														11.1	0.08	6	SV...11...
	■	■	■	■	■	■	■	■												11.1	0.15	6	SV...11...
	■	■	■	■	■	■	■	■												11.1	0.35	6	SV...11...

Application range of chip breaker

Properties:

- polished rake
- ground clearance
- sharp cutting edge "F"
- submicrograin carbide, heat and wear resistant

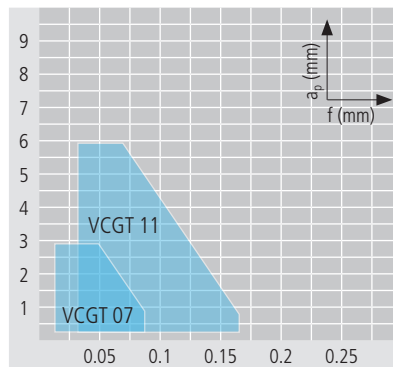

Application:

- micro finishing
- chip breaker for general application
- stainless steel, alloyed steel, titanium, super alloy, aluminum and synthetics reinforced/composites

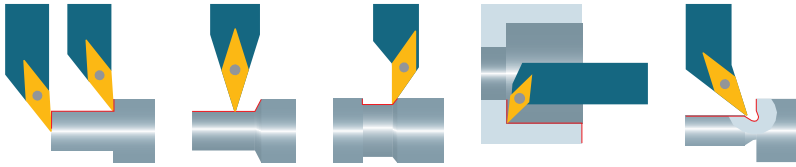

VCGT ... EN -A3

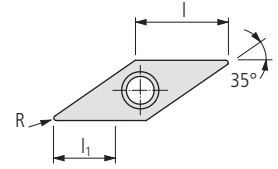

Order designation	Carbide												Cermet	Diamond		Dimensions			Holder					
	UHM 10	UHM 10 HX	UHM 10 TX+	UHM 10 MZ	UHM 20	UHM 20 HPX	UHM 20 TX+	UHM 20 MZ	UHM 30	UHM 30 HX	UHM 30 TX+	UHM 30 MZ		UHM 30 SX	UCM 10	UCM 10 HX	UCM 10 MZ	UCVD 08	UPCD 15	UPCD 20	l	R	l ₁	283...
	-	-	•	•	•	•	•	•	•	•	•	•	•	•	•	•	•	•	•	•				
	○	•	•	-	-	○	•	•	○	•	•	•	•	•	•	○	-	-	-	-				
	•	○	-	-	-	-	-	-	-	-	-	-	-	-	-	-	-	-	-	-				
	-	-	•	-	-	-	-	-	-	-	-	-	-	-	-	-	-	-	-	-				

STANDARD-LINE

N	Order designation	UHM 10	UHM 10 HX	UHM 10 TX+	UHM 10 MZ	UHM 20	UHM 20 HPX	UHM 20 TX+	UHM 20 MZ	UHM 30	UHM 30 HX	UHM 30 TX+	UHM 30 MZ	UHM 30 SX	UCM 10	UCM 10 HX	UCM 10 MZ	UCVD 08	UPCD 15	UPCD 20	l	R	l ₁	Holder	
	VCGT 1103008 EN-A3 ...					■	■	■													11.1	0.08	6	SV...11...	
	VCGT 1103015 EN-A3 ...					■	■	■														11.1	0.15	6	SV...11...
	VCGT 1103035 EN-A3 ...					■	■	■														11.1	0.35	6	SV...11...

Application range of chip breaker

Properties:

- polished rake
- ground clearance
- little rounded cutting edge "E"
- submicrograin carbide, heat and wear resistant

Optimal chip breaking

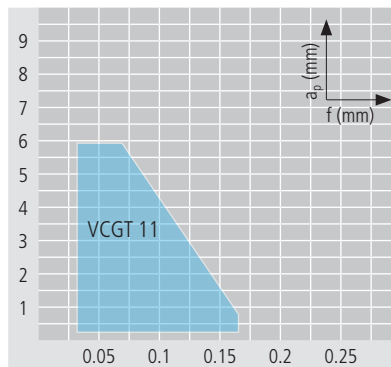

Application:

- finishing
- chip breaker for general application
- stainless steel, alloyed steel, titanium, super alloy, aluminum and synthetics reinforced/composites

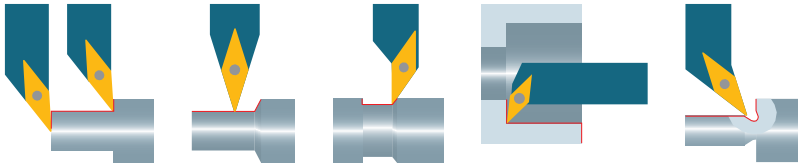

262

UTILIS
multidec
swiss type tools



VCGT ... -PA5

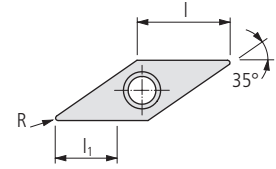

Order designation	Carbide														Cermet		Diamond		Dimensions			Holder	
	UHM 10	UHM 10 HX	UHM 10 TX+	UHM 10 MZ	UHM 20	UHM 20 HPX	UHM 20 TX+	UHM 20 MZ	UHM 30	UHM 30 HX	UHM 30 TX+	UHM 30 MZ	UHM 30 SX	UCM 10	UCM 10 HX	UCM 10 MZ	UCVD 08	UPCD 15	UPCD 20	l	R	l ₁	□ 283...
	-	-	●	●	○	●	●	●	○	●	●	○	○	●	●	○	-	-	-				
	○	●	●	-	-	○	●	○	-	○	○	-	-	○	○	-	-	-	-				
	○	○	-	-	-	-	-	-	-	-	-	-	-	-	-	-	●	●	●				
	-	-	●	-	-	○	○	-	-	-	-	-	-	-	-	-	-	-	-				

STANDARD-LINE

N	Order designation	Material	l	R	l ₁	Holder
	VCGT 110302 FN -PA5 ...	■ ■ ■	11.1	0.2	6.8	SV...11...
	VCGT 110304 FN -PA5 ...	■ ■ ■	11.1	0.4	6.8	SV...11...
	VCGT 160404 FN -PA5 ...	■ ■ ■	16.6	0.4	8.9	SV...16...
	VCGT 160408 FN -PA5 ...	■ ■ ■	16.6	0.8	8.9	SV...16...

Application range of chip breaker

Properties:

- polished rake
- ground clearance
- sharp cutting edge "F"
- submicrograin carbide, heat and wear resistant

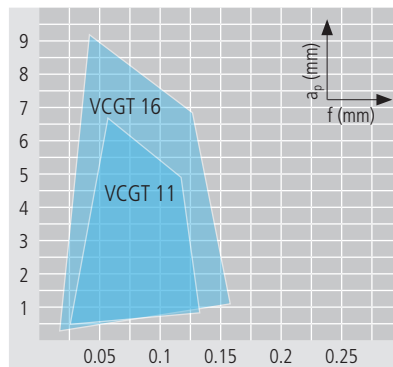

Optimal chip breaking

Application:

- finishing and micro finishing
- chip breaker for materials with difficult chip control
- stainless steel, alloyed steel, titanium, super alloy, aluminum and synthetics reinforced/composites

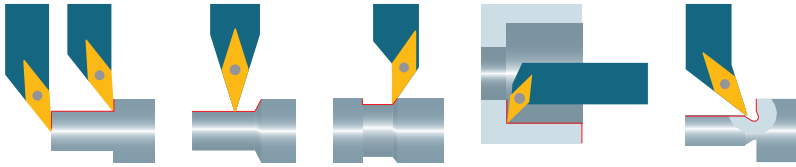

VCGT ... -TOP5*

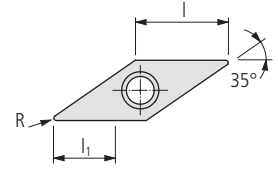

Order designation	Carbide													Cermet	Diamond		Dimensions			Holder				
	UHM 10	UHM 10 HX	UHM 10 TX+	UHM 10 MZ	UHM 20	UHM 20 HPX	UHM 20 TX+	UHM 20 MZ	UHM 30	UHM 30 HX	UHM 30 TX+	UHM 30 MZ	UHM 30 SX		UCM 10	UCM 10 HX	UCM 10 MZ	UCVD 08	UPCD 15	UPCD 20	I	R	I ₁	283...
	-	-	●	●	○	●	●	○	○	○	●	●	○	●	●	○	-	-	-	-	-	-	-	-
	○	○	●	●	-	○	○	○	○	○	○	○	○	○	○	○	-	-	-	-	-	-	-	-
	○	○	-	-	-	-	-	-	-	-	-	-	-	-	-	-	-	-	-	-	-	-	-	
	○	○	○	○	○	○	○	○	○	○	○	○	○	○	○	○	○	○	○	○	○	○	○	

STANDARD-LINE

	UHM 10	UHM 10 HX	UHM 10 TX+	UHM 10 MZ	UHM 20	UHM 20 HPX	UHM 20 TX+	UHM 20 MZ	UHM 30	UHM 30 HX	UHM 30 TX+	UHM 30 MZ	UHM 30 SX	UCM 10	UCM 10 HX	UCM 10 MZ	UCVD 08	UPCD 15	UPCD 20	I	R	I ₁	Holder
L VCGT 110304 FL-TOP5 ...	■	■	■	■																11.1	0.4	7	SV...11...
R VCGT 110304 FR-TOP5 ...	■	■	■	■																11.1	0.4	7	SV...11...

* Description TOP 13

Application range of chip breaker

- Properties:**
- polished rake and ground clearance
 - sharp cutting edge "F"
 - micrograin carbide, heat and wear resistant
 - TOP system, for a better surface finish

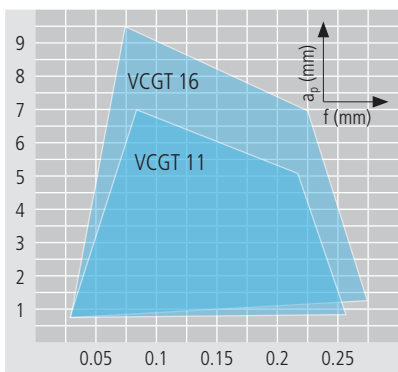

Optimal chip breaking

- Application:**
- finishing for 20–100 % higher feed rates compared to the standard
 - chip breaker for materials with difficult chip control
 - stainless steel, alloyed steel, titanium, super alloy, aluminum and synthetics reinforced/composites

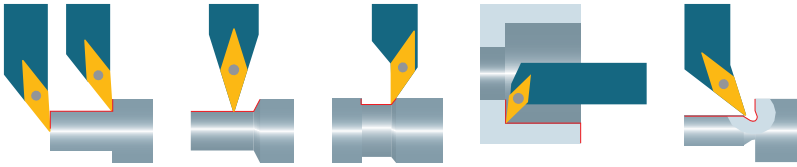

264

UTILIS
multidec
swiss type tools



VCGT ... -PA7

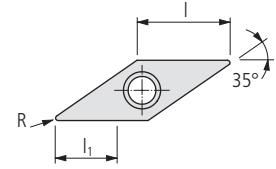

Order designation	Carbide														Cermet		Diamond		Dimensions			Holder	
	UHM 10	UHM 10 HX	UHM 10 TX+	UHM 10 MZ	UHM 20	UHM 20 HPX	UHM 20 TX+	UHM 20 MZ	UHM 30	UHM 30 HX	UHM 30 TX+	UHM 30 MZ	UHM 30 SX	UCM 10	UCM 10 HX	UCM 10 MZ	UCVD 08	UPCD 15	UPCD 20	L	R	l ₁	□ 283...
	-	-	●	●	○	●	●	○	○	○	○	○	○	○	○	○	-	-	-				
	-	●	●	-	-	●	●	-	-	-	-	-	-	-	-	-	-	-	-				
	○	○	-	-	-	-	-	-	-	-	-	-	-	-	-	-	-	-	-				
	-	-	●	-	-	-	-	-	-	-	-	-	-	-	-	-	-	-	-				

STANDARD-LINE

N	Order designation	Material														Dimensions			Holder		
		Al	St	Ti	Co	Al	St	Ti	Co	Al	St	Ti	Co	Al	St	Ti	Co	L	R	l ₁	□ 283...
	VCGT 1103005 FN -PA7 ...	■	■	■														11.1	0.05	5.5	SV...11...
	VCGT 110301 FN -PA7 ...	■	■	■														11.1	0.1	5.5	SV...11...
	VCGT 110302 FN -PA7 ...	■	■	■														11.1	0.2	5.5	SV...11...
	VCGT 110304 FN -PA7 ...	■	■	■														11.1	0.4	5.5	SV...11...
	VCGT 110308 FN -PA7 ...	■	■	■														11.1	0.8	5.5	SV...11...
	VCGT 160402 FN -PA7 ...	■	■	■														16.6	0.2	8.9	SV...16...
	VCGT 160404 FN -PA7 ...	■	■	■														16.6	0.4	8.9	SV...16...
	VCGT 160408 FN -PA7 ...	■	■	■														16.6	0.8	8.9	SV...16...

Application range of chip breaker

Properties:

- ground clearance
- sharp cutting edge "F"
- micrograin carbide, heat and wear resistant

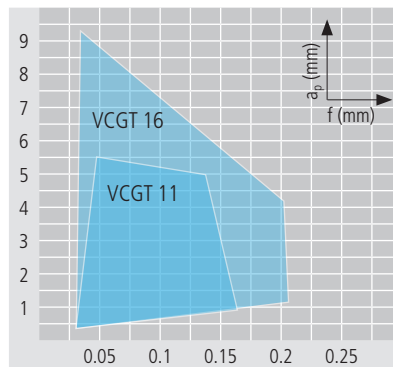

Optimal chip breaking

Application:

- micro finishing
- chip breaker for materials with good chip control
- stainless steel, alloyed steel, titanium, super alloy, aluminum and synthetics reinforced/composites

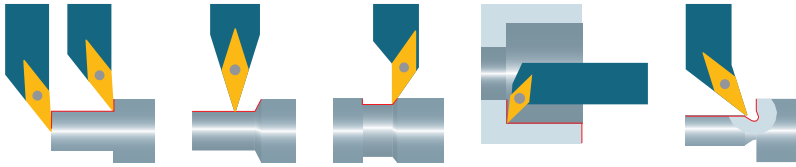

VCXT ... -PA9

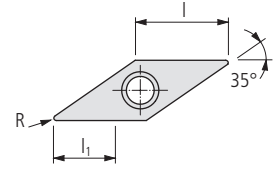

β : 25°
 s : ±0.1
 C : <0.01

Order designation	Carbide														Cermet		Diamond		Dimensions			Holder	
	UHM 10	UHM 10 HX	UHM 10 TX+	UHM 10 MZ	UHM 20	UHM 20 HPX	UHM 20 TX+	UHM 20 MZ	UHM 30	UHM 30 HX	UHM 30 TX+	UHM 30 MZ	UHM 30 SX	UCM 10	UCM 10 HX	UCM 10 MZ	UCVD 08	UPCD 15	UPCD 20	L	R	l ₁	283...
	-	-	●	●	○	●	●	○	○	○	●	●	○	○	●	●	-	-	-				
	○	●	●	-	-	○	○	○	○	○	○	○	○	○	○	○	-	-	-				
	●	○	-	-	-	○	○	○	○	○	○	○	○	○	○	-	-	-					
	-	-	●	-	-	-	-	-	-	-	-	-	-	-	-	-	-	-					

VALUE-LINE

N	Order designation	Material	Length (mm)	Width (mm)	Height (mm)	Holder
	VCXT 160404 EN -PA9 ...	■ ■ □	16.6	0.4	8.9	SV...16...
	VCXT 160408 EN -PA9 ...	■ ■ □	16.6	0.8	8.9	SV...16...

Application range of chip breaker

Properties:

- high precision sintered insert
- rounded cutting edge "E"
- micrograin carbide, heat and wear resistant
- best performance-cost ratio

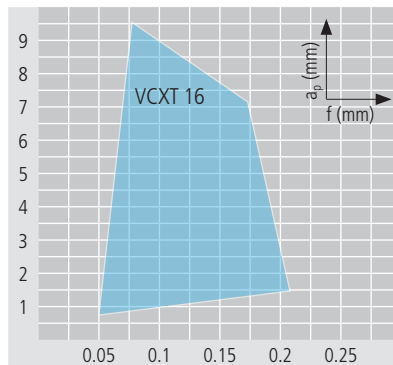

Optimal chip breaking

Application:

- finishing
- chip breaker for soft materials with good chip control
- alloyed steel, stainless steel, super alloy, titanium and aluminum

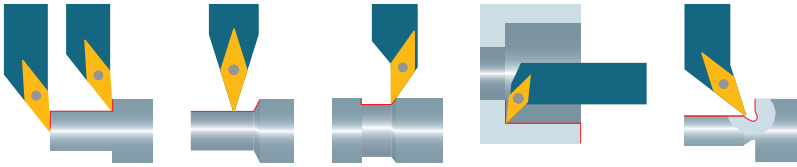

VCGT ... -PF

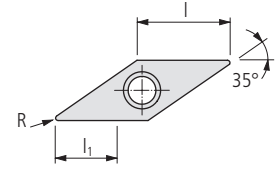

Order designation	Carbide												Cermet			Diamond			Dimensions			Holder	
	UHM 10	UHM 10 HX	UHM 10 TX+	UHM 10 MZ	UHM 20	UHM 20 HPX	UHM 20 TX+	UHM 20 MZ	UHM 30	UHM 30 HX	UHM 30 TX+	UHM 30 MZ	UHM 30 SX	UCM 10	UCM 10 HX	UCM 10 MZ	UCVD 08	UPCD 15	UPCD 20	l	R	l ₁	□ 283...
	-	-	●	●	○	●	●	●	○	●	●	○	○	●	●	●	-	-	-				
	○	●	●	-	-	○	●	○	-	-	-	-	-	○	-	-	-	-	-				
	●	○	-	-	-	○	-	-	-	-	-	-	-	-	-	-	●	●	●				
	-	-	●	-	-	-	○	-	-	-	-	-	-	-	-	-	-	-	-				

STANDARD-LINE

	VCGT 110302 EN -PF ...	VCGT 110304 EN -PF ...	VCGT 110308 EN -PF ...	VCGT 160404 EN -PF ...	VCGT 160408 EN -PF ...	l	R	l ₁	Holder
N	■	■	■	■	■	11.1	0.2	4.8	SV...11...
		■	■		■	11.1	0.4	4.8	SV...11...
			■		■	11.1	0.8	4.8	SV...11...
				■	■	16.6	0.4	6	SV...16...
					■	16.6	0.8	6	SV...16...

Application range of chip breaker

Properties:

- ground clearance
- little rounded cutting edge "E"
- carbide and cermet in different grades

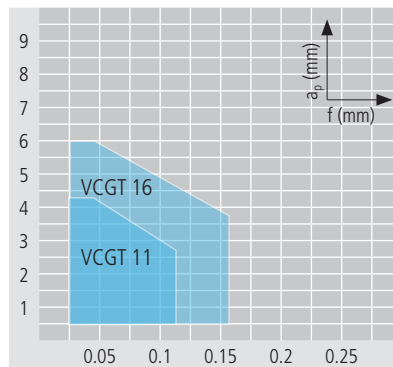

Optimal chip breaking

Application:

- finishing and micro finishing
- chip breaker for general application
- alloyed steel and stainless steel

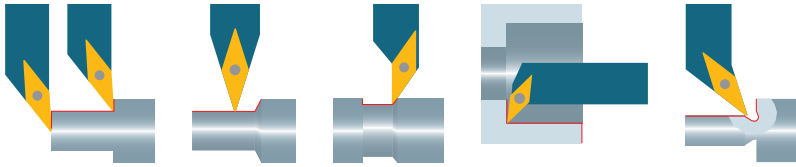

VCMT ... -PF

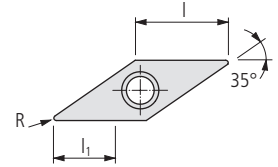

Order designation	Carbide														Cermet		Diamond		Dimensions			Holder	
	UHM 10	UHM 10 HX	UHM 10 TX+	UHM 10 MZ	UHM 20	UHM 20 HPX	UHM 20 TX+	UHM 20 MZ	UHM 30	UHM 30 HX	UHM 30 TX+	UHM 30 MZ	UHM 30 SX	UCM 10	UCM 10 HX	UCM 10 MZ	UCVD 08	UPCD 15	UPCD 20	l	R	l ₁	283...
	-	-	●	●	○	●	●	○	○	○	○	○	○	○	○	○	-	-	-	16.6	0.4	6	SV...16...
	○	●	●	-	○	●	●	○	○	○	○	○	○	○	○	○	-	-	-	16.6	0.8	6	SV...16...
	●	○	-	-	○	○	○	-	-	-	-	-	-	-	-	-	●	●	●				
	-	-	●	-	-	-	-	-	-	-	-	-	-	-	-	-	-	-	-				

VALUE-LINE

N	Order designation	UHM 10	UHM 10 HX	UHM 10 TX+	UHM 10 MZ	UHM 20	UHM 20 HPX	UHM 20 TX+	UHM 20 MZ	UHM 30	UHM 30 HX	UHM 30 TX+	UHM 30 MZ	UHM 30 SX	UCM 10	UCM 10 HX	UCM 10 MZ	UCVD 08	UPCD 15	UPCD 20	l	R	l ₁	Holder	
	VCMT 160404 EN -PF ...			■				■				■									16.6	0.4	6	SV...16...	
	VCMT 160408 EN -PF ...			■				■				■										16.6	0.8	6	SV...16...

Application range of chip breaker

- Properties:**
- sintered insert based on ISO standard
 - rounded cutting edge "E"
 - carbide and cermet in different grades

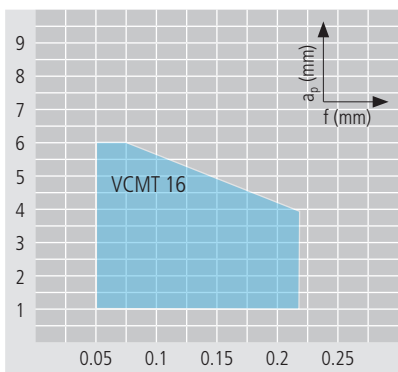

- Application:**
- roughing
 - chip breaker for general application
 - alloyed steel and stainless steel

Optimal chip breaking

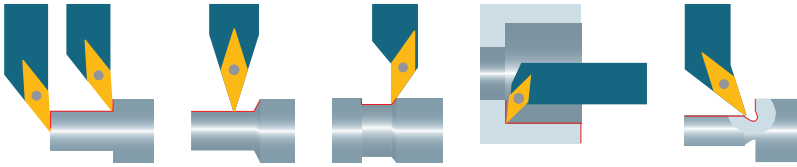

VCET ... -PF05

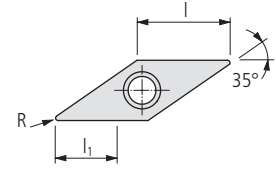

Order designation	Carbide														C20		Cermet		Diamond		Dimensions			Holder
	UHM 10	UHM 10 HX	UHM 10 TX+	UHM 10 MZ	UHM 20	UHM 20 HPX	UHM 20 TX+	UHM 20 MZ	UHM 30	UHM 30 HX	UHM 30 TX+	UHM 30 MZ	UHM 30 SX	UCM 10	UCM 10 HX	UCM 10 MZ	UCVD 08	UPCD 15	UPCD 20	l	R	l ₁	□ 283...	
	-	-	●	●	○	●	●	●	○	●	●	○	●	●	●	●	-	-	-					
	○	●	●	-	-	○	○	○	○	○	○	○	○	○	○	○	-	-	-					
	●	○	-	-	-	-	-	-	-	-	-	-	-	-	-	-	●	●	●					
	-	-	●	-	-	-	-	-	-	-	-	-	-	-	-	-	-	-	-					

PREMIUM-LINE

N	Order designation	Material	l	R	l ₁	Holder
	VCET 1103005 FN -PF05	■	11.1	0.05	3	SD...11...
	VCET 110301 FN -PF05	■	11.1	0.1	3	SD...11...
	VCET 1103015 FN -PF05	■	11.1	0.15	3	SD...11...
	VCET 110302 FN -PF05	■	11.1	0.2	3	SD...11...
	VCET 110304 FN -PF05	■	11.1	0.4	3	SD...11...

Application range of chip breaker multidec®-ISO

Properties:

- polished rake
- ground clearance
- sharp cutting edge "F"
- submicrograin carbide, heat and wear resistant

Optimal chip breaking

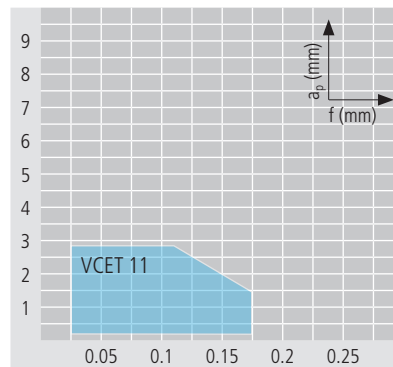

Application:

- micro finishing
- chip breaker for materials with difficult chip control
- stainless steel, alloyed steel, titanium, super alloy, aluminum and synthetics reinforced/composites

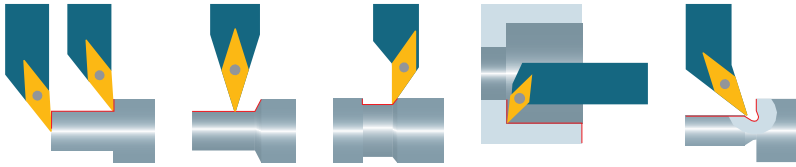

VCGT ... FN -PF23

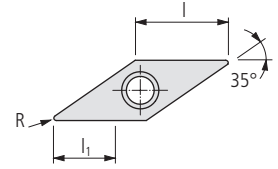

Order designation	Carbide														Cermet	Diamond	Dimensions			Holder				
	UHM 10	UHM 10 HX	UHM 10 TX+	UHM 10 MZ	UHM 20	UHM 20 HPX	UHM 20 TX+	UHM 20 MZ	UHM 30	UHM 30 HX	UHM 30 TX+	UHM 30 MZ	UHM 30 SX	UCM 10			UCM 10 HX	UCM 10 MZ	UCVD 08		UPCD 15	UPCD 20	L	R
	-	-	●	●	○	●	●	●	○	○	●	●	○	○	●	●	○	-	-	-				
	○	●	●	-	-	○	○	○	○	○	○	○	○	○	○	○	○	-	-	-				
	●	○	-	-	-	-	-	-	-	-	-	-	-	-	-	-	-	-	-					
	-	○	●	-	-	○	○	○	○	○	○	○	○	○	○	○	○	○	○					

STANDARD-LINE

N	Order designation	Material														Dimensions			Holder					
		Al	St	StP	StA	StB	StC	StD	StE	StF	StG	StH	StI	StJ	StK	StL	StM	StN		StO	StP	L	R	l ₁
	VCGT 1103005 FN -PF23 ...					■	■	■			■										11.1	0.05	4.8	SV...11...
	VCGT 110301 FN -PF23 ...					■	■	■			■										11.1	0.1	4.8	SV...11...
	VCGT 110302 FN -PF23 ...					■	■	■			■										11.1	0.2	4.8	SV...11...
	VCGT 160401 FN -PF23 ...					■	■	■			■										16.6	0.1	8.4	SV...16...
	VCGT 160402 FN -PF23 ...					■	■	■			■										16.6	0.2	8.4	SV...16...

Application range of chip breaker

Properties:

- polished rake
- ground clearance
- sharp cutting edge "F"
- micrograin carbide

Optimal chip breaking

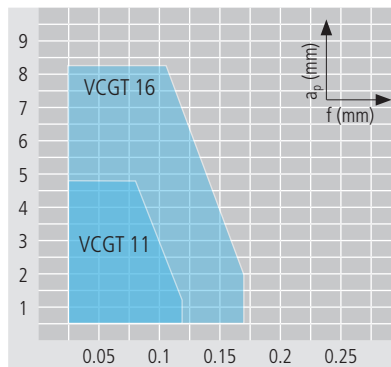

Application:

- micro finishing
- chip breaker for materials with difficult chip control
- alloyed steel and stainless steel

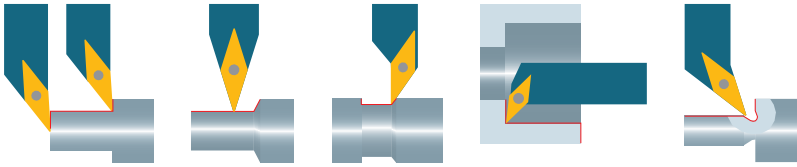

270

UTILIS
multidec
swiss type tools



VCGT ... EN -PF23

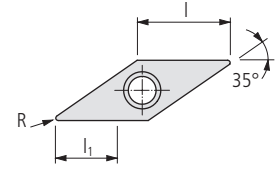

Order designation	Carbide												Cermet		Diamond		Dimensions			Holder			
	UHM 10	UHM 10 HX	UHM 10 TX+	UHM 10 MZ	UHM 20	UHM 20 HPX	UHM 20 TX+	UHM 20 MZ	UHM 30	UHM 30 HX	UHM 30 TX+	UHM 30 MZ	UHM 30 SX	UCM 10	UCM 10 HX	UCM 10 MZ	UCVD 08	UPCD 15	UPCD 20	l	R	l ₁	□ 283...
	-	-	●	●	○	●	●	●	○	●	●	○	○	●	●	○	-	-	-				
	○	●	●	-	-	○	●	○	-	○	●	-	-	○	-	-	-	-	-				
	●	○	-	-	-	○	-	-	-	-	-	-	-	-	-	-	●	●	●				
	-	-	●	-	-	-	-	-	-	-	-	-	-	-	-	-	-	-	-				

STANDARD-LINE

	VCGT 1103005 EN -PF23 ...	VCGT 110301 EN -PF23 ...	VCGT 110302 EN -PF23 ...	VCGT 160401 EN -PF23 ...	VCGT 160402 EN -PF23 ...	l	R	l ₁	Holder
N			■ ■ ■	■ ■ ■		11.1	0.05	4.8	SV...11...
			■ ■ ■	■ ■ ■		11.1	0.1	4.8	SV...11...
			■ ■ ■	■ ■ ■		11.1	0.2	4.8	SV...11...
			■ ■ ■	■ ■ ■		16.6	0.1	8.4	SV...16...
			■ ■ ■	■ ■ ■		16.6	0.2	8.4	SV...16...

Application range of chip breaker

Properties:

- polished rake
- ground clearance
- little rounded cutting edge "E"
- micrograin carbide

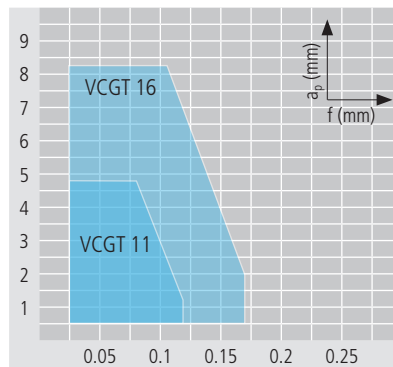

Optimal chip breaking

Application:

- finishing
- chip breaker for materials with difficult chip control
- alloyed steel and stainless steel

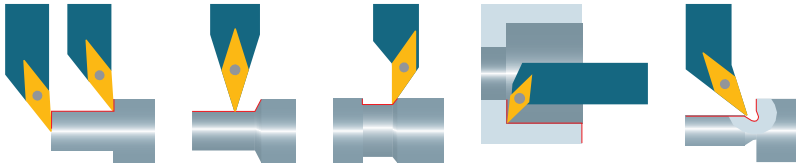

VCGT ... FN -PF33

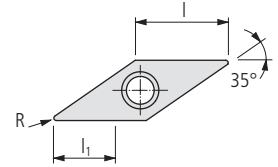

β : 12°
 s : ±0.13
 C : <0.002

Order designation	Carbide												Cermet		Diamond		Dimensions			Holder			
	UHM 10	UHM 10 HX	UHM 10 TX+	UHM 10 MZ	UHM 20	UHM 20 HPX	UHM 20 TX+	UHM 20 MZ	UHM 30	UHM 30 HX	UHM 30 TX+	UHM 30 MZ	UHM 30 SX	UCM 10	UCM 10 HX	UCM 10 MZ	UCVD 08	UPCD 15	UPCD 20	L	R	l ₁	□ 283...
	-	-	●	●	○	●	●	●	○	●	●	●	○	●	●	●	-	-	-				
	○	●	●	-	○	●	●	●	○	●	●	●	-	○	●	○	-	-	-				
	●	○	-	-	-	○	-	-	-	-	-	-	-	-	-	-	●	●	●				
	-	-	●	-	-	○	-	-	-	-	-	-	-	-	-	-	-	-	-				

STANDARD-LINE

	VCGT 1103005 FN -PF33 ...	VCGT 110301 FN -PF33 ...	VCGT 110302 FN -PF33 ...	VCGT 110304 FN -PF33 ...	VCGT 160401 FN -PF33 ...	VCGT 160402 FN -PF33 ...	VCGT 160404 FN -PF33 ...																	
N				■	■	■		■													11.1	0.05	4.8	SV...11...
				■	■	■		■													11.1	0.1	4.8	SV...11...
				■	■	■		■													11.1	0.2	4.8	SV...11...
				■	■	■		■													11.1	0.4	4.8	SV...11...
				■	■	■		■													16.6	0.1	8.4	SV...16...
				■	■	■		■													16.6	0.2	8.4	SV...16...
				■	■	■		■													16.6	0.4	8.4	SV...16...

Application range of chip breaker

Properties:

- polished rake
- ground clearance
- sharp cutting edge "F"
- micrograin carbide

Optimal chip breaking

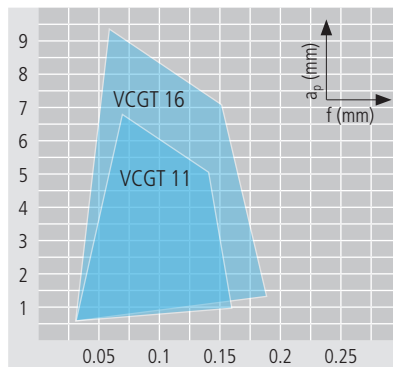

Application:

- micro finishing
- chip breaker for materials with difficult chip control
- alloyed steel and stainless steel

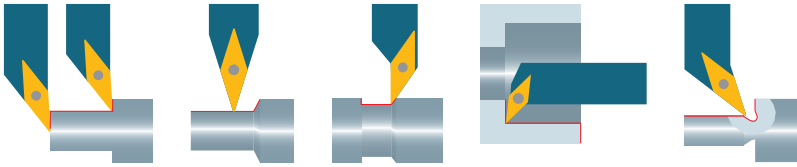

VCGT ... EN -PF33

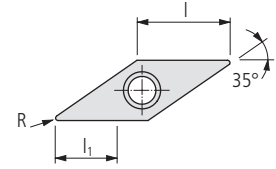

Order designation	Carbide												Cermet		Diamond		Dimensions			Holder			
	UHM 10	UHM 10 HX	UHM 10 TX+	UHM 10 MZ	UHM 20	UHM 20 HPX	UHM 20 TX+	UHM 20 MZ	UHM 30	UHM 30 HX	UHM 30 TX+	UHM 30 MZ	UHM 30 SX	UCM 10	UCM 10 HX	UCM 10 MZ	UCVD 08	UPCD 15	UPCD 20	l	R	l ₁	□ 283...
	-	-	●	●	○	●	●	●	○	○	○	○	○	○	○	○	-	-	-				
	○	●	●	-	-	○	○	○	○	○	○	○	○	○	○	○	-	-	-				
	○	○	-	-	-	-	-	-	-	-	-	-	-	-	-	-	-	-	-				
	-	-	●	-	-	○	○	○	-	-	-	-	-	-	-	-	●	●	●				

STANDARD-LINE

N	Order designation	Carbide												Cermet		Diamond		Dimensions			Holder		
		UHM 10	UHM 10 HX	UHM 10 TX+	UHM 10 MZ	UHM 20	UHM 20 HPX	UHM 20 TX+	UHM 20 MZ	UHM 30	UHM 30 HX	UHM 30 TX+	UHM 30 MZ	UHM 30 SX	UCM 10	UCM 10 HX	UCM 10 MZ	UCVD 08	UPCD 15	UPCD 20	l	R	l ₁
	VCGT 1103005 EN -PF33 ...					■	■	■												11.1	0.05	4.8	SV...11...
	VCGT 110301 EN -PF33 ...					■	■	■												11.1	0.1	4.8	SV...11...
	VCGT 110302 EN -PF33 ...					■	■	■												11.1	0.2	4.8	SV...11...
	VCGT 110304 EN -PF33 ...					■	■	■												11.1	0.4	4.8	SV...11...
	VCGT 160401 EN -PF33 ...					■	■	■												16.6	0.1	8.4	SV...16...
	VCGT 160402 EN -PF33 ...					■	■	■												16.6	0.2	8.4	SV...16...
	VCGT 160404 EN -PF33 ...					■	■	■												16.6	0.4	8.4	SV...16...

Application range of chip breaker

Properties:

- polished rake
- ground clearance
- little rounded cutting edge "E"
- micrograin carbide

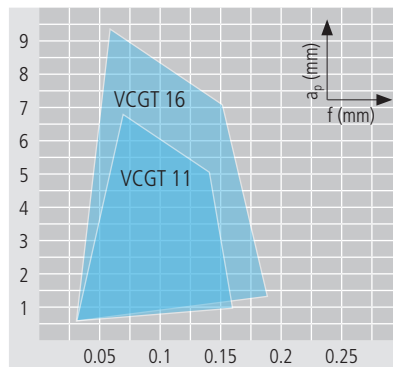

Optimal chip breaking

Application:

- finishing
- chip breaker for materials with difficult chip control
- alloyed steel and stainless steel

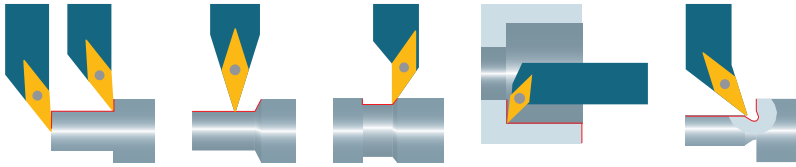

VCMT ... -PF43

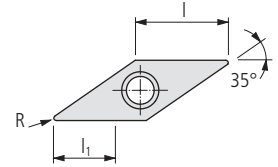

Order designation	Carbide														Cermet	Diamond		Dimensions			Holder			
	UHM 10	UHM 10 HX	UHM 10 TX+	UHM 10 MZ	UHM 20	UHM 20 HPX	UHM 20 TX+	UHM 20 MZ	UHM 30	UHM 30 HX	UHM 30 TX+	UHM 30 MZ	UHM 30 SX	UCM 10		UCM 10 HX	UCM 10 MZ	UCVD 08	UPCD 15	UPCD 20	L	R	l ₁	□ 283...
	-	-	●	●	○	●	●	●	○	○	●	●	○	○	●	●	○	-	-	-				
	○	●	●	-	-	○	○	○	○	○	○	○	○	○	○	○	-	-	-					
	●	○	-	-	-	-	-	-	-	-	-	-	-	-	-	-	●	●	●					
	-	○	●	●	○	○	○	○	○	○	○	○	○	○	○	○	-	-	-					

VALUE-LINE

N	Order designation	Material														Dimensions			Holder							
		Al	Al-Si	Al-Cu	Al-Ti	Al-Ni	Al-Mn	Al-Mg	Al-Zn	Al-Pb	Al-Sn	Al-In	Al-Ag	Al-Cd	Al-Sb	Al-Bi	Al-Mo	Al-Nb	Al-Ta	Al-W	Al-Co	Al-Ni-Co	L	R	l ₁	Holder
	VCMT 110302 EN -PF43 ...																						11.1	0.2	4.8	SV...11...
	VCMT 110304 EN -PF43 ...																						11.1	0.4	4.8	SV...11...
	VCMT 160404 EN -PF43 ...																						16.6	0.4	7	SV...16...

Application range of chip breaker

Properties:

- sintered insert based on ISO standard
- rounded cutting edge "E"
- micrograin carbide

Optimal chip breaking

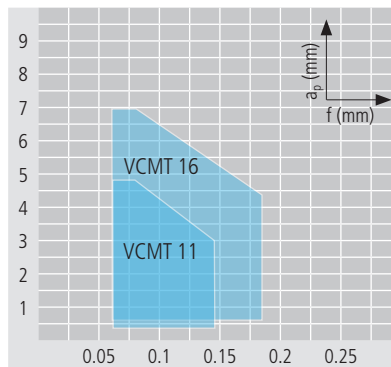

Application:

- roughing and finishing
- chip breaker for materials with difficult chip control
- alloyed steel and stainless steel

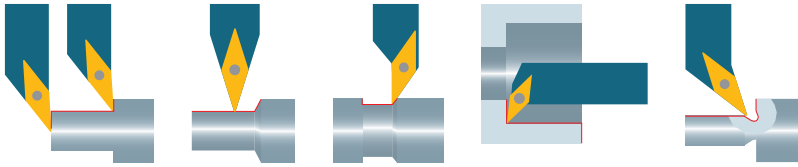

274

UTILIS
multidec
swiss type tools



VCMT ... -PM

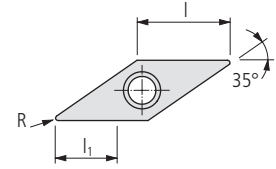

Order designation	Carbide																Cermet	Diamond	Dimensions			Holder □283...	
	UHM 10	UHM 10 HX	UHM 10 TX+	UHM 10 MZ	UHM 20	UHM 20 HPX	UHM 20 TX+	UHM 20 MZ	UHM 30	UHM 30 HX	UHM 30 TX+	UHM 30 MZ	UHM 30 SX	UCM 10	UCM 10 HX	UCM 10 MZ			UCVD 08	UPCD 15	UPCD 20		L
VCMT 160404 EN -PM ...			■				■			■										16.6	0.4	6	SV...16...
VCMT 160408 EN -PM ...			■				■			■										16.6	0.8	6	SV...16...

VALUE-LINE



Application range of chip breaker

Properties:

- sintered insert based on ISO standard
- rounded cutting edge "E"
- micrograin carbide

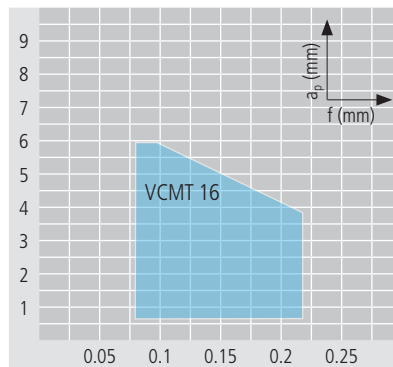

Optimal chip breaking

Application:

- roughing
- chip breaker for general application
- alloyed steel and stainless steel

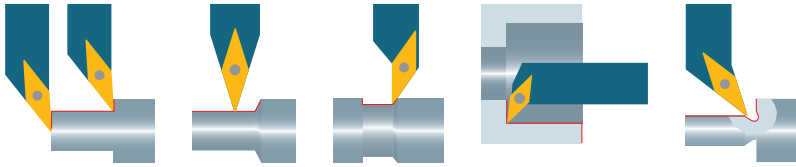

VCMT ... -PMF

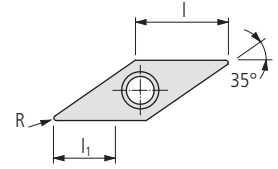

Order designation	Carbide														Cermet	Diamond		Dimensions			Holder			
	UHM 10	UHM 10 HX	UHM 10 TX+	UHM 10 MZ	UHM 20	UHM 20 HPX	UHM 20 TX+	UHM 20 MZ	UHM 30	UHM 30 HX	UHM 30 TX+	UHM 30 MZ	UHM 30 SX	UCM 10		UCM 10 HX	UCM 10 MZ	UCVD 08	UPCD 15	UPCD 20	L	R	l ₁	□ 283...
	-	-	●	●	○	●	●	●	○	○	●	●	○	○	●	●	○	-	-	-				
	○	●	●	-	-	○	○	○	○	○	○	○	○	○	○	○	○	-	-	-				
	●	○	-	-	-	-	-	-	-	-	-	-	-	-	-	-	●	●	●					
	-	-	●	-	-	-	-	-	-	-	-	-	-	-	-	-	-	-	-					

VALUE-LINE

N	Order designation	UHM 10	UHM 10 HX	UHM 10 TX+	UHM 10 MZ	UHM 20	UHM 20 HPX	UHM 20 TX+	UHM 20 MZ	UHM 30	UHM 30 HX	UHM 30 TX+	UHM 30 MZ	UHM 30 SX	UCM 10	UCM 10 HX	UCM 10 MZ	UCVD 08	UPCD 15	UPCD 20	L	R	l ₁	Holder
	VCMT 110304 EN -PMF ...														■						11.1	0.4	4.1	SV...11...
	VCMT 160404 EN -PMF ...														■						16.6	0.4	6	SV...16...
	VCMT 160408 EN -PMF ...														■						16.6	0.8	6	SV...16...

Application range of chip breaker

Properties:

- sintered insert based on ISO standard
- rounded cutting edge "E"
- micrograin carbide

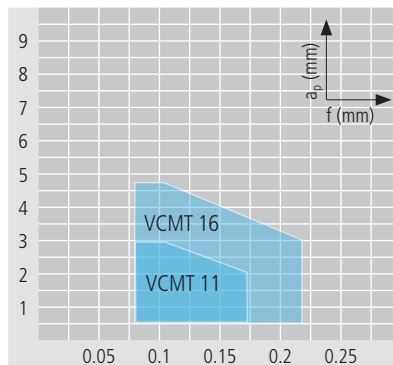

Optimal chip breaking

Application:

- roughing and finishing
- chip breaker for general application
- alloyed steel and stainless steel

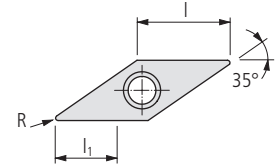
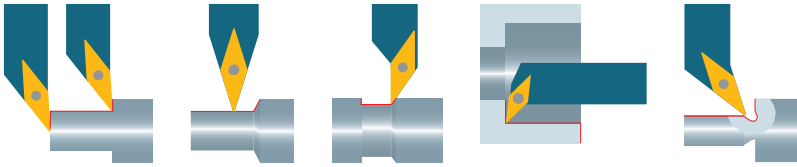

VCMT ... -PM25

Order designation	Carbide												Cermet		Diamond		Dimensions			Holder			
	UHM 10	UHM 10 HX	UHM 10 TX+	UHM 10 MZ	UHM 20	UHM 20 HPX	UHM 20 TX+	UHM 20 MZ	UHM 30	UHM 30 HX	UHM 30 TX+	UHM 30 MZ	UHM 30 SX	UCM 10	UCM 10 HX	UCM 10 MZ	UCVD 08	UPCD 15	UPCD 20	I	R	l ₁	□ 283...
	-	-	●	●	○	●	●	●	○	●	●	○	○	○	○	○	-	-	-	16.6	0.4	2.2	SV...16...

VALUE-LINE

N	VCMT 160404 EN -PM25 ...				■														16.6	0.4	2.2		SV...16...

Application range of chip breaker

Properties:

- sintered insert based on ISO standard
- rounded cutting edge "E"
- carbide and cermet in different grades

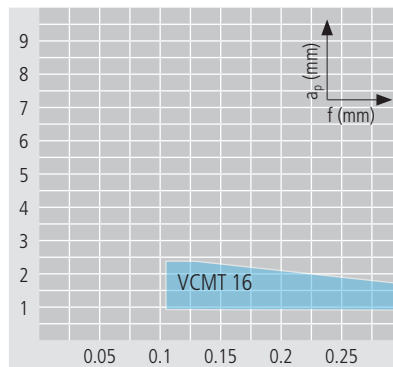

Optimal chip breaking

Application:

- roughing and finishing
- chip breaker for general application
- stainless steel

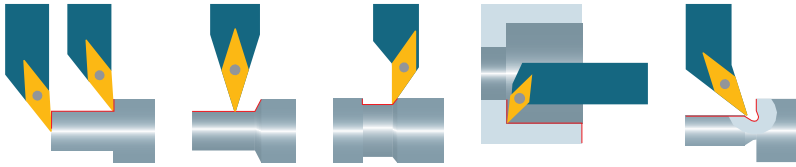

VCMT ... -PM55

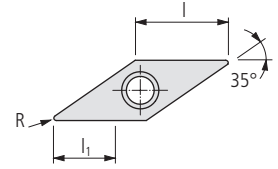

β : 16°
s: ±0.13
C: <0.02

Order designation	Carbide														Cermet		Diamond		Dimensions			Holder	
	UHM 10	UHM 10 HX	UHM 10 TX+	UHM 10 MZ	UHM 20	UHM 20 HPX	UHM 20 TX+	UHM 20 MZ	UHM 30	UHM 30 HX	UHM 30 TX+	UHM 30 MZ	UHM 30 SX	UCM 10	UCM 10 HX	UCM 10 MZ	UCVD 08	UPCD 15	UPCD 20	L	R	I ₁	□283...
	-	-	●	●	○	●	●	●	○	●	●	●	○	●	●	●	-	-	-				
	○	●	●	-	-	○	○	○	○	○	○	○	○	○	○	○	-	-	-				
	●	○	-	-	-	-	-	-	-	-	-	-	-	-	-	-	●	●	●				
	-	●	●	●	○	○	○	○	○	○	○	○	○	○	○	○	-	-	-				

VALUE-LINE

N	Order designation	UHM 10	UHM 10 HX	UHM 10 TX+	UHM 10 MZ	UHM 20	UHM 20 HPX	UHM 20 TX+	UHM 20 MZ	UHM 30	UHM 30 HX	UHM 30 TX+	UHM 30 MZ	UHM 30 SX	UCM 10	UCM 10 HX	UCM 10 MZ	UCVD 08	UPCD 15	UPCD 20	L	R	I ₁	Holder	
	VCMT 160404 EN -PM55 ...					■															16.6	0.4	3	SV...16...	
	VCMT 160408 EN -PM55 ...					■																16.6	0.8	3.4	SV...16...

Application range of chip breaker

Properties:

- sintered insert based on ISO standard
- rounded cutting edge "E"
- carbide and cermet in different grades

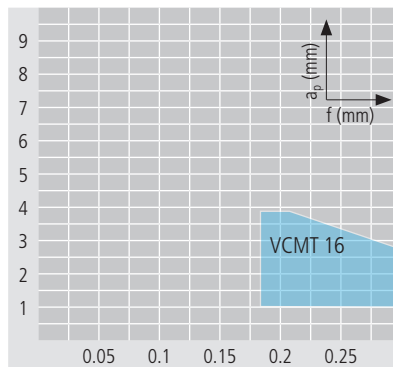

Optimal chip breaking

Application:

- roughing
- chip breaker for general application
- stainless steel

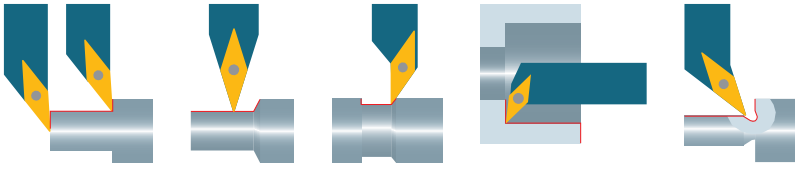

VCGT ...

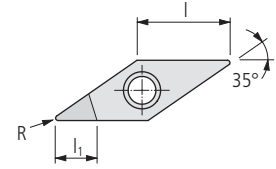

Order designation	Carbide														Cermet		Diamond		Dimensions			Holder	
	UHM 10	UHM 10 HX	UHM 10 TX+	UHM 10 MZ	UHM 20	UHM 20 HPX	UHM 20 TX+	UHM 20 MZ	UHM 30	UHM 30 HX	UHM 30 TX+	UHM 30 MZ	UHM 30 SX	UCM 10	UCM 10 HX	UCM 10 MZ	UCVD 08	UPCD 15	UPCD 20	l	R	l ₁	Holder
	-	-	●	●	○	●	●	●	○	●	●	○	○	○	○	○	-	-	-	11.1	0.1	5.4	SV...11...
	○	●	●	-	-	○	○	○	○	○	○	○	○	○	○	○	-	-	-	11.1	0.2	4.6	SV...11...
	○	○	-	-	-	-	-	-	-	-	-	-	-	-	-	-	●	●	●	16.6	0.2	5.9	SV...16...
	-	-	●	-	-	○	○	○	○	○	○	○	○	○	○	-	-	-	16.6	0.4	5.5	SV...16...	

STANDARD-LINE

N	VCGT 110301 FN ...																■	■	11.1	0.1	5.4		SV...11...	
	VCGT 110302 FN ...																	■	■	11.1	0.2	4.6		SV...11...
	VCGT 160402 FN ...																	■	■	16.6	0.2	5.9		SV...16...
	VCGT 160404 FN ...																	■	■	16.6	0.4	5.5		SV...16...

Application range of chip breaker

Properties:

- sharp cutting edge "F"
- less cutting force
- positive cut

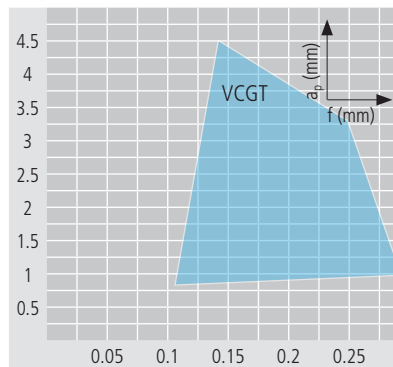

Optimal chip breaking

Application:

- finishing and micro finishing for unstable or thin-walled parts
- chip breaker for general application will generate continuous chip
- aluminum, brass, copper, bronze, platinum, gold, synthetics and synthetics reinforced/composites
- ideal for smallest tolerance and medium surface quality

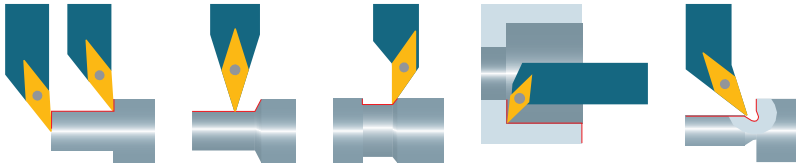

VCGT ... -UWS

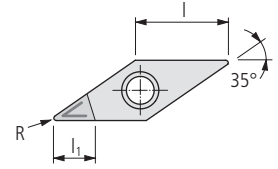

Order designation	Carbide														C20	Cermet	Diamond			Dimensions			Holder □283...	
	UHM 10	UHM 10 HX	UHM 10 TX+	UHM 10 MZ	UHM 20	UHM 20 HPX	UHM 20 TX+	UHM 20 MZ	UHM 30	UHM 30 HX	UHM 30 TX+	UHM 30 MZ	UHM 30 SX	UCM 10			UCM 10 HX	UCM 10 MZ	UCVD 08	UPCD 15	UPCD 20	l		R
	-	-	●	●	○	●	●	○	○	○	○	○	○	○	○	○	○	○	○	○	○	○	○	○
	○	●	●	-	-	○	○	○	○	○	○	○	○	○	○	○	○	○	○	○	○	○	○	○
	○	○	-	-	-	-	-	-	-	-	-	-	-	-	-	-	-	-	-	-	-	-	-	-
	-	○	○	○	○	○	○	○	○	○	○	○	○	○	○	○	○	○	○	○	○	○	○	○

STANDARD-LINE

N	Order designation	Material														l (mm)	R (mm)	l ₁ (mm)	Holder										
		UHM 10	UHM 10 HX	UHM 10 TX+	UHM 10 MZ	UHM 20	UHM 20 HPX	UHM 20 TX+	UHM 20 MZ	UHM 30	UHM 30 HX	UHM 30 TX+	UHM 30 MZ	UHM 30 SX	UCM 10					UCM 10 HX	UCM 10 MZ	UCVD 08	UPCD 15	UPCD 20					
	VCGT 110301 FN -UWS ...																■	■							11.1	0.1	4.6	SV...11...	
	VCGT 110302 FN -UWS ...																■	■	■							11.1	0.2	4.6	SV...11...
	VCGT 110304 FN -UWS ...																■	■	■							11.1	0.4	3.9	SV...11...
	VCGT 160402 FN -UWS ...																■	■								16.6	0.2	5.9	SV...16...
	VCGT 160404 FN -UWS ...																■	■	■							16.6	0.4	5.5	SV...16...
	VCGT 160408 FN -UWS ...																■	■	■							16.6	0.8	5	SV...16...

Application range of chip breaker

Properties:

- sharp cutting edge "F"
- almost any cutting force
- high positive narrow chip breaker made by laser

Optimal chip breaking

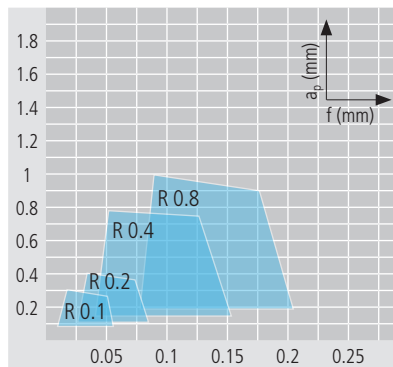

Application:

- micro finishing for unstable or thin-walled parts
- chip breaker for materials with difficult chip control
- synthetics reinforced/composites, aluminum, platinum, gold and synthetics
- ideal for smallest tolerance and medium surface quality

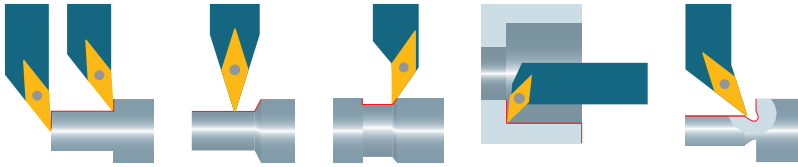

280

UTILIS
multidec
swiss type tools



VCGT ... -UWN

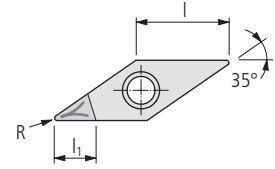

Order designation	Carbide														Cermet		Diamond		Dimensions			Holder	
	UHM 10	UHM 10 HX	UHM 10 TX+	UHM 10 MZ	UHM 20	UHM 20 HPX	UHM 20 TX+	UHM 20 MZ	UHM 30	UHM 30 HX	UHM 30 TX+	UHM 30 MZ	UHM 30 SX	UCM 10	UCM 10 HX	UCM 10 MZ	UCVD 08	UPCD 15	UPCD 20	l	R	l ₁	□ 283...
	-	-	●	●	○	●	●	●	○	○	●	●	○	○	●	●	-	-	-	11.1	0.2	4.6	SV...11...
	○	●	●	-	-	○	○	-	-	-	-	-	-	-	-	-	-	-	11.1	0.4	3.9	SV...11...	
	●	○	-	-	-	-	-	-	-	-	-	-	-	-	-	-	●	●	16.6	0.4	5.5	SV...16...	
	-	-	●	●	○	●	●	○	○	○	●	●	○	○	●	●	-	-					

STANDARD-LINE

N	Order designation	UHM 10	UHM 10 HX	UHM 10 TX+	UHM 10 MZ	UHM 20	UHM 20 HPX	UHM 20 TX+	UHM 20 MZ	UHM 30	UHM 30 HX	UHM 30 TX+	UHM 30 MZ	UHM 30 SX	UCM 10	UCM 10 HX	UCM 10 MZ	UCVD 08	UPCD 15	UPCD 20	l	R	l ₁	Holder	
	VCGT 110302 FN -UWN ...																	■	■		11.1	0.2	4.6	SV...11...	
	VCGT 110304 FN -UWN ...																		■	■		11.1	0.4	3.9	SV...11...
	VCGT 160404 FN -UWN ...																		■	■		16.6	0.4	5.5	SV...16...

Application range of chip breaker

Properties:

- sharp cutting edge "F"
- higher cutting force
- high positive wide chip breaker made by laser

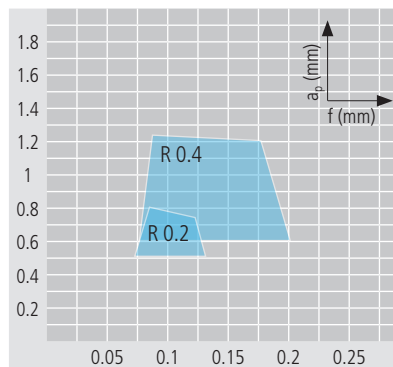

Optimal chip breaking

Application:

- finishing for stable or solid parts
- chip breaker for materials with difficult chip control
- synthetics reinforced/composites, aluminum, platinum, gold and synthetics
- ideal for smallest tolerance and best surface quality



VCGW ...

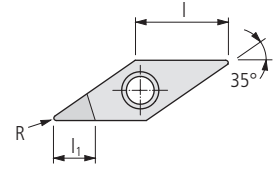

Order designation	Carbide														Cermet		Diamond		Dimensions			Holder		
	UHM 10	UHM 10 HX	UHM 10 TX+	UHM 10 MZ	UHM 20	UHM 20 HPX	UHM 20 TX+	UHM 20 MZ	UHM 30	UHM 30 HX	UHM 30 TX+	UHM 30 MZ	UHM 30 SX	UCM 10	UCM 10 HX	UCM 10 MZ	UCVD 08	UPCD 15	UPCD 20	l	R	l ₁	283...	
	-	-	●	●	○	●	●	○	○	○	●	●	○	○	●	●	○	-	-	-				
	○	●	●	-	-	○	○	○	○	○	○	○	○	○	○	○	-	-	-					
	○	○	-	-	-	○	○	○	○	○	○	○	○	○	○	○	-	-	-					
	-	-	●	-	-	○	○	○	○	○	○	○	○	○	○	○	○	○	○					

STANDARD-LINE

N	Order designation	Carbide														Cermet		Diamond		Dimensions			Holder	
		UHM 10	UHM 10 HX	UHM 10 TX+	UHM 10 MZ	UHM 20	UHM 20 HPX	UHM 20 TX+	UHM 20 MZ	UHM 30	UHM 30 HX	UHM 30 TX+	UHM 30 MZ	UHM 30 SX	UCM 10	UCM 10 HX	UCM 10 MZ	UCVD 08	UPCD 15	UPCD 20	l	R	l ₁	283...
	VCGW 110301 FN ...																■	■	■	11.1	0.1	4.6		SV...11...
	VCGW 110302 FN ...																■	■	■	11.1	0.2	4.6		SV...11...
	VCGW 110304 FN ...																■	■	■	11.1	0.4	3.9		SV...11...
	VCGW 160404 FN ...																■	■	■	16.6	0.4	5.5		SV...16...
	VCGW 160408 FN ...																■	■	■	16.6	0.8	5		SV...16...

Application range of chip breaker

- Properties:**
- sharp cutting edge "F"
 - medium cutting force
 - neutral cut

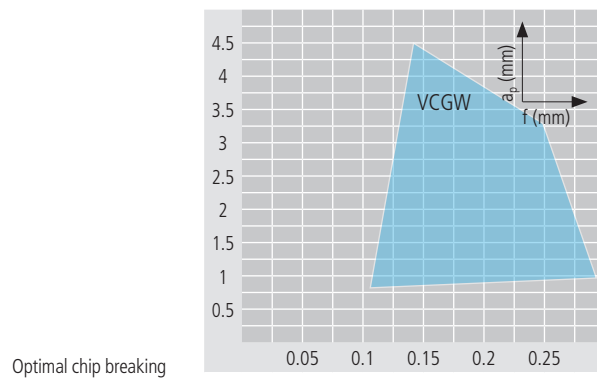

- Application:**
- finishing and micro finishing for stable or solid parts
 - chip breaker for general application will generate continues chip
 - aluminum, brass, copper, bronze, platinum, gold, synthetics and synthetics reinforced/composites
 - ideal for smallest tolerance and high surface quality

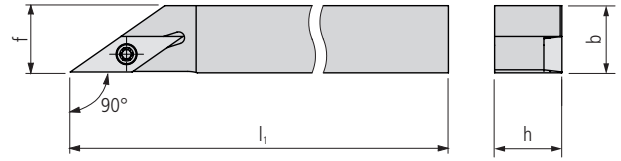

SVAC... U (90°)

Order designation		Dimensions							Inserts
L	R	h	b	l ₁	f			□259...	

STANDARD-LINE

SVACL 0808 F11 U	■	SVACR 0808 F11 U	■	8	8	80	7.85		VC..1103..
SVACL 0808 H07 U	■	SVACR 0808 H07 U	■	8	8	100	7.85		VC..0702..
SVACL 0808 H11 U	■	SVACR 0808 H11 U	■	8	8	100	7.85		VC..1103..
SVACL 1010 F11 U	■	SVACR 1010 F11 U	■	10	10	80	9.85		VC..1103..
SVACL 1010 H07 U	■	SVACR 1010 H07 U	■	10	10	100	9.85		VC..0702..
SVACL 1010 H11 U	■	SVACR 1010 H11 U	■	10	10	100	9.85		VC..1103..
SVACL 1212 H07 U	■	SVACR 1212 H07 U	■	12	12	100	11.85		VC..0702..
SVACL 1212 H11 U	■	SVACR 1212 H11 U	■	12	12	100	11.85		VC..1103..

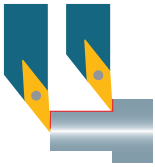

284

UTILIS **multidec**®
swiss type tools

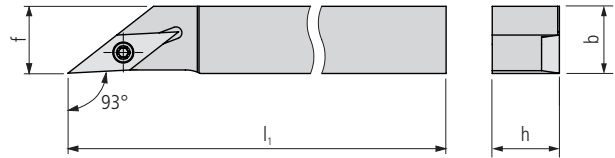

SVJC... U (93°)

Order designation		Dimensions							Inserts
L	R	h	b	l ₁		f		□ 259...	

STANDARD-LINE

SVJCL 0808 F11 U	■	SVJCR 0808 F11 U	■	8	8	80		7.95		VC..1103..
SVJCL 0808 H07 U	■	SVJCR 0808 H07 U	■	8	8	100		7.95		VC..0702..
SVJCL 0808 H11 U	■	SVJCR 0808 H11 U	■	8	8	100		7.95		VC..1103..
SVJCL 1010 F11 U	■	SVJCR 1010 F11 U	■	10	10	80		9.95		VC..1103..
SVJCL 1010 H07 U	■	SVJCR 1010 H07 U	■	10	10	100		9.95		VC..0702..
SVJCL 1010 H11 U	■	SVJCR 1010 H11 U	■	10	10	100		9.95		VC..1103..
SVJCL 1212 H07 U	■	SVJCR 1212 H07 U	■	12	12	100		11.95		VC..0702..
SVJCL 1212 H11 U	■	SVJCR 1212 H11 U	■	12	12	100		11.95		VC..1103..
SVJCL 1216 H16 U	■	SVJCR 1216 H16 U	■	12	16	100		15.95		VC..1604..
SVJCL 1616 K11 U	■	SVJCR 1616 K11 U	■	16	16	125		15.95		VC..1103..
SVJCL 1616 K16 U	■	SVJCR 1616 K16 U	■	16	16	125		15.95		VC..1604..
SVJCL 2020 K11 U	■	SVJCR 2020 K11 U	■	20	20	125		19.95		VC..1103..
SVJCL 2020 K16 U	■	SVJCR 2020 K16 U	■	20	20	125		19.95		VC..1604..

SVJC... U (93°) INCH

Order designation		Dimensions							Inserts
L	R	h	b	l ₁		f		□ 259...	

STANDARD-LINE

SVJCL 3/8" F11 U	■	SVJCR 3/8" F11 U	■	9.525	9.525	80		9.475		VC..1103..
SVJCL 3/8" H07 U	■	SVJCR 3/8" H07 U	■	9.525	9.525	100		9.475		VC..0702..
SVJCL 3/8" H11 U	■	SVJCR 3/8" H11 U	■	9.525	9.525	100		9.475		VC..1103..
SVJCL 1/2" H07 U	■	SVJCR 1/2" H07 U	■	12.7	12.7	100		12.65		VC..0702..
SVJCL 1/2" H11 U	■	SVJCR 1/2" H11 U	■	12.7	12.7	100		12.65		VC..1103..
SVJCL 1/2"-5/8" H16 U	■	SVJCR 1/2"-5/8" H16 U	■	12.7	15.875	100		15.825		VC..1604..
SVJCL 3/4" K11 U	■	SVJCR 3/4" K11 U	■	19.05	19.05	125		19		VC..1103..
SVJCL 3/4" K16 U	■	SVJCR 3/4" K16 U	■	19.05	19.05	125		19		VC..1604..

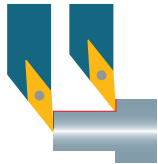

With internal cooling

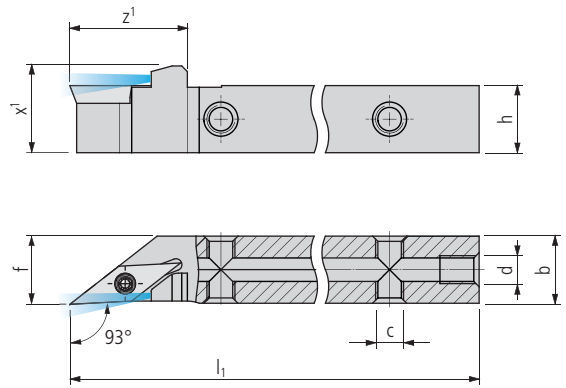

SVJC... U IC (93°)

Order designation		Dimensions										Inserts
L	R	h	b	l ₁	z ¹	x ¹	c	d	f	□ 259...		

PREMIUM-LINE

SVJCL 0808 H07 U IC	■	SVJCR 0808 H07 U IC	■	8	8	100	20	11.5	M5	M5	8	VC.. 0702..
SVJCL 0810 H11 U IC	■	SVJCR 0810 H11 U IC	■	8	10	100	21	11.5	M5	M5	10	VC.. 1103..
SVJCL 1010 H07 U IC	■	SVJCR 1010 H07 U IC	■	10	10	100	20	13.5	M5	M5	10	VC.. 0702..
SVJCL 1010 H11 U IC	■	SVJCR 1010 H11 U IC	■	10	10	100	21	13.5	M5	M5	10	VC.. 1103..
SVJCL 1212 H07 U IC	■	SVJCR 1212 H07 U IC	■	12	12	100	20	15.5	M5	M5	12	VC.. 0702..
SVJCL 1212 H11 U IC	■	SVJCR 1212 H11 U IC	■	12	12	100	21	15.5	M5	M5	12	VC.. 1103..
SVJCL 1216 H16 U IC	■	SVJCR 1216 H16 U IC	■	12	16	100	27	15.5	M5	M5	12	VC.. 1604..
SVJCL 1616 K11 U IC	■	SVJCR 1616 K11 U IC	■	16	16	125	21	19.5	M5	G ¹ / ₈ "	16	VC.. 1103..
SVJCL 1616 K16 U IC	■	SVJCR 1616 K16 U IC	■	16	16	125	27	19.5	M5	G ¹ / ₈ "	16	VC.. 1604..
SVJCL 2020 K11 U IC	■	SVJCR 2020 K11 U IC	■	20	20	125	21	23.5	M5	G ¹ / ₈ "	20	VC.. 1103..
SVJCL 2020 K16 U IC	■	SVJCR 2020 K16 U IC	■	20	20	125	27	23.5	M5	G ¹ / ₈ "	20	VC.. 1604..

SVJC... U IC (93°) INCH

Order designation		Dimensions										Inserts
L	R	h	b	l ₁	z ¹	x ¹	c	d	f	□ 259...		

PREMIUM-LINE

SVJCL 3/8" H07 U IC	■	SVJCR 3/8" H07 U IC	■	9.525	9.525	100	20	13	M5	M5	9.525	VC.. 0702..
SVJCL 3/8" H11 U IC	■	SVJCR 3/8" H11 U IC	■	9.525	9.525	100	21	13	M5	M5	9.525	VC.. 1103..
SVJCL 1/2" H07 U IC	■	SVJCR 1/2" H07 U IC	■	12.7	12.7	100	20	16.2	M5	M5	12.7	VC.. 0702..
SVJCL 1/2" H11 U IC	■	SVJCR 1/2" H11 U IC	■	12.7	12.7	100	21	16.2	M5	M5	12.7	VC.. 1103..
SVJCL 1/2"-5/8" H16 U IC	■	SVJCR 1/2"-5/8" H16 U IC	■	12.7	15.875	100	27	16.2	M5	M5	12.7	VC.. 1604..
SVJCL 5/8" K11 U IC	■	SVJCR 5/8" K11 U IC	■	15.875	15.875	125	21	19.5	M5	G ¹ / ₈ "	15.875	VC.. 1103..
SVJCL 5/8" K16 U IC	■	SVJCR 5/8" K16 U IC	■	15.875	15.875	125	27	19.5	M5	G ¹ / ₈ "	15.875	VC.. 1604..
SVJCL 3/4" K11 U IC	■	SVJCR 3/4" K11 U IC	■	19.05	19.05	125	21	22.6	M5	G ¹ / ₈ "	19.05	VC.. 1103..
SVJCL 3/4" K16 U IC	■	SVJCR 3/4" K16 U IC	■	19.05	19.05	125	27	22.6	M5	G ¹ / ₈ "	19.05	VC.. 1604..

Scope of delivery: Holder without coolant connector
 Coolant system □ 619...

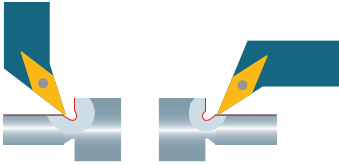

286

UTILIS **multidec**®
swiss type tools

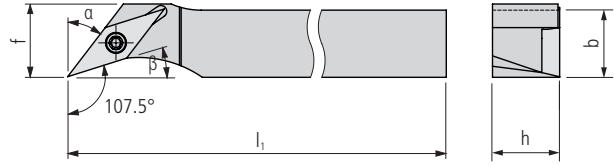

SVHC... U (107.5°)

Order designation		Dimensions							Inserts
L	R	h	b	l ₁	f	a	β	□ 259...	

STANDARD-LINE

SVHCL 0808 H07 U	■	SVHCR 0808 H07 U	■	8	8	100	8.5	37.5°	17.5°	VC..0702..
SVHCL 1010 H07 U	■	SVHCR 1010 H07 U	■	10	10	100	10	37.5°	17.5°	VC..0702..
SVHCL 1010 H11 U	■	SVHCR 1010 H11 U	■	10	10	100	13	37.5°	17.5°	VC..1103..
SVHCL 1212 H07 U	■	SVHCR 1212 H07 U	■	12	12	100	12	37.5°	17.5°	VC..0702..
SVHCL 1212 H11 U	■	SVHCR 1212 H11 U	■	12	12	100	13	37.5°	17.5°	VC..1103..
SVHCL 1616 K11 U	■	SVHCR 1616 K11 U	■	16	16	125	16	37.5°	17.5°	VC..1103..

SVHC... U (107.5°) INCH

Order designation		Dimensions							Inserts
L	R	h	b	l ₁	f	a	β	□ 259...	

STANDARD-LINE

SVHCL 3/8" H07 U	■	SVHCR 3/8" H07 U	■	9.525	9.525	100	9.525	37.5°	17.5°	VC..0702..
SVHCL 3/8" H11 U	■	SVHCR 3/8" H11 U	■	9.525	9.525	100	13	37.5°	17.5°	VC..1103..
SVHCL 1/2" H07 U	■	SVHCR 1/2" H07 U	■	12.7	12.7	100	12.7	37.5°	17.5°	VC..0702..
SVHCL 1/2" H11 U	■	SVHCR 1/2" H11 U	■	12.7	12.7	100	13	37.5°	17.5°	VC..1103..
SVHCL 5/8" K11 U	■	SVHCR 5/8" K11 U	■	15.875	15.875	125	16	37.5°	17.5°	VC..1103..

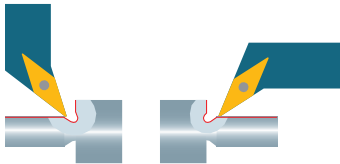

With internal cooling

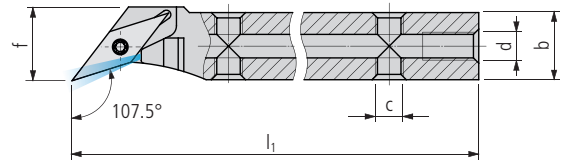
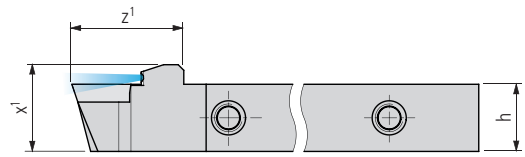

SVHC... U IC (107.5°)

Order designation		Dimensions										Inserts
L	R	h	b	l ₁	z ¹	x ¹	c	d	f	□ 259...		

PREMIUM-LINE

SVHCL 0808 H07 U IC	■	SVHCR 0808 H07 U IC	■	8	8	100	18	11.5	M5	M5	8.5	VC..0702..
SVHCL 1010 H07 U IC	■	SVHCR 1010 H07 U IC	■	10	10	100	18	13.5	M5	M5	10	VC..0702..
SVHCL 1212 H07 U IC	■	SVHCR 1212 H07 U IC	■	12	12	100	18	15.5	M5	M5	12	VC..0702..
SVHCL 1212 H11 U IC	■	SVHCR 1212 H11 U IC	■	12	12	100	22	15.5	M5	M5	13	VC..1103..
SVHCL 1616 K11 U IC	■	SVHCR 1616 K11 U IC	■	16	16	125	22	19.5	M5	G½"	16	VC..1103..

SVHC... U IC (107.5°) INCH

Order designation		Dimensions										Inserts
L	R	h	b	l ₁	z ¹	x ¹	c	d	f	□ 259...		

PREMIUM-LINE

SVHCL 3/8" H07 U IC	■	SVHCR 3/8" H07 U IC	■	9.525	9.525	100	18	13	M5	M5	9.525	VC..0702..
SVHCL 1/2" H07 U IC	■	SVHCR 1/2" H07 U IC	■	12.7	12.7	100	18	16.2	M5	M5	12.7	VC..0702..
SVHCL 1/2" H11 U IC	■	SVHCR 1/2" H11 U IC	■	12.7	12.7	100	22	16.2	M5	M5	12.7	VC..1103..
SVHCL 5/8" K11 U IC	■	SVHCR 5/8" K11 U IC	■	15.875	15.875	125	22	19.4	M5	G½"	15.875	VC..1103..

Scope of delivery: Holder without coolant connector

Coolant system □ 619...

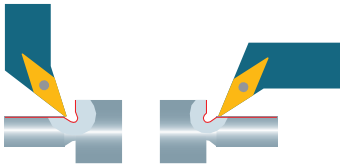

288

UTILIS **multidec**®
swiss type tools

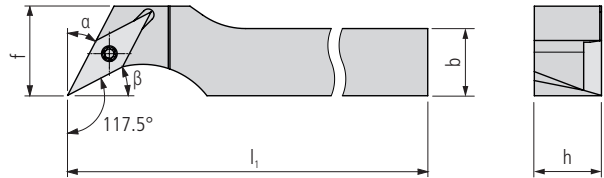

SVPC... U (117.5°)

Order designation		Dimensions								Inserts
L	R	h	b	l ₁		f		α	β	□ 259...

STANDARD-LINE

SVPC 0808 H07 U	■	SVPCR 0808 H07 U	■	8	8	100		10		27.5°	27.5°	VC..0702..
SVPC 1010 H07 U	■	SVPCR 1010 H07 U	■	10	10	100		10		27.5°	27.5°	VC..0702..
SVPC 1010 H11 U	■	SVPCR 1010 H11 U	■	10	10	100		16		27.5°	27.5°	VC..1103..
SVPC 1212 H07 U	■	SVPCR 1212 H07 U	■	12	12	100		12		27.5°	27.5°	VC..0702..
SVPC 1212 H11 U	■	SVPCR 1212 H11 U	■	12	12	100		16		27.5°	27.5°	VC..1103..
SVPC 1616 K11 U	■	SVPCR 1616 K11 U	■	16	16	125		16		27.5°	27.5°	VC..1103..

SVPC... U (117.5°) INCH

Order designation		Dimensions								Inserts
L	R	h	b	l ₁		f		α	β	□ 259...

STANDARD-LINE

SVPC 3/8" H07 U	■	SVPCR 3/8" H07 U	■	9.525	9.525	100		10		27.5°	27.5°	VC..0702..
SVPC 3/8" H11 U	■	SVPCR 3/8" H11 U	■	9.525	9.525	100		16		27.5°	27.5°	VC..1103..
SVPC 1/2" H07 U	■	SVPCR 1/2" H07 U	■	12.7	12.7	100		12.7		27.5°	27.5°	VC..0702..
SVPC 1/2" H11 U	■	SVPCR 1/2" H11 U	■	12.7	12.7	100		16		27.5°	27.5°	VC..1103..
SVPC 5/8" K11 U	■	SVPCR 5/8" K11 U	■	15.875	15.875	125		16		27.5°	27.5°	VC..1103..

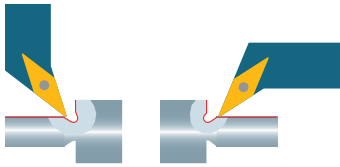

With internal cooling



SVPC... U IC (117.5°)

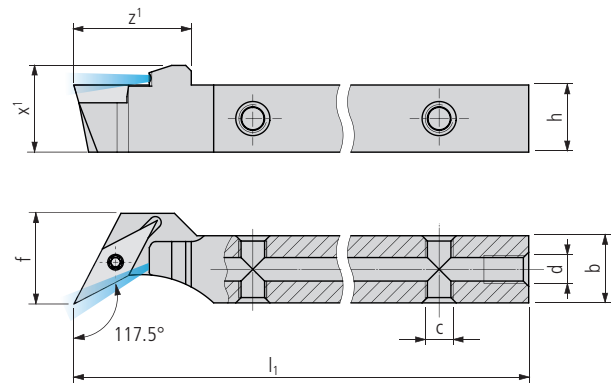

Order designation		Dimensions										Inserts
L	R	h	b	l ₁	z ¹	x ¹	c	d	f	□ 259...		

PREMIUM-LINE

SVPC 0808 H07 U IC	■	SVPCR 0808 H07 U IC	■	8	8	100	18	11.5	M5	M5	10	VC..0702..
SVPC 1010 H07 U IC	■	SVPCR 1010 H07 U IC	■	10	10	100	18	13.5	M5	M5	10	VC..0702..
SVPC 1010 H11 U IC	■	SVPCR 1010 H11 U IC	■	10	10	100	22	13.5	M5	M5	16	VC..1103..
SVPC 1212 H07 U IC	■	SVPCR 1212 H07 U IC	■	12	12	100	18	15.5	M5	M5	12	VC..0702..
SVPC 1212 H11 U IC	■	SVPCR 1212 H11 U IC	■	12	12	100	22	15.5	M5	M5	16	VC..1103..
SVPC 1616 K11 U IC	■	SVPCR 1616 K11 U IC	■	16	16	125	22	19.5	M5	G½"	16	VC..1103..

SVPC... U IC (117.5°) INCH

Order designation		Dimensions										Inserts
L	R	h	b	l ₁	z ¹	x ¹	c	d	f	□ 259...		

PREMIUM-LINE

SVPC 3/8" H07 U IC	■	SVPCR 3/8" H07 U IC	■	9.525	9.525	100	18	13	M5	M5	10	VC..0702..
SVPC 3/8" H11 U IC	■	SVPCR 3/8" H11 U IC	■	9.525	9.525	100	22	13	M5	M5	16	VC..1103..
SVPC 1/2" H07 U IC	■	SVPCR 1/2" H07 U IC	■	12.7	12.7	100	18	16.2	M5	M5	12.9	VC..0702..
SVPC 1/2" H11 U IC	■	SVPCR 1/2" H11 U IC	■	12.7	12.7	100	22	16.2	M5	M5	16	VC..1103..
SVPC 5/8" K11 U IC	■	SVPCR 5/8" K11 U IC	■	15.875	15.875	125	22	19.4	M5	G½"	15.875	VC..1103..

Scope of delivery: Holder without coolant connector
 Coolant system □ 619...



290

UTILIS
 multidec®
 SWISS type tools

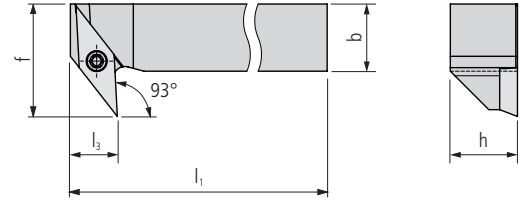

SVQC... (93°)

Order designation		Dimensions							Inserts
L	R	h	b	l ₁	f	l ₃		□ 259...	

STANDARD-LINE

SVQCL 0808 H07	■	SVQCR 0808 H07	■	8	8	100	13.5	6	VC..0702..
SVQCL 1010 H07	■	SVQCR 1010 H07	■	10	10	100	15.5	6	VC..0702..
SVQCL 1212 H07	■	SVQCR 1212 H07	■	12	12	100	17.5	6	VC..0702..
SVQCL 1212 H11	■	SVQCR 1212 H11	■	12	12	100	20	8.5	VC..1103..
SVQCL 1616 K11	■	SVQCR 1616 K11	■	16	16	125	24	8.5	VC..1103..

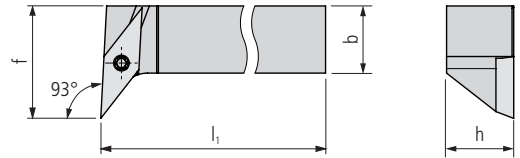

SVUC... (93°)

Order designation		Dimensions								Inserts
L	R	h	b	l ₁	f					□ 259...

STANDARD-LINE

SVUCL 0808 H07	■	SVUCR 0808 H07	■	8	8	100	13.5			VC..0702..
SVUCL 1010 H07	■	SVUCR 1010 H07	■	10	10	100	15.5			VC..0702..
SVUCL 1212 H07	■	SVUCR 1212 H07	■	12	12	100	17.5			VC..0702..
SVUCL 1212 H11	■	SVUCR 1212 H11	■	12	12	100	20			VC..1103..
SVUCL 1616 K11	■	SVUCR 1616 K11	■	16	16	125	24			VC..1103..
SVUCL 2020 K11	■	SVUCR 2020 K11	■	20	20	125	28			VC..1103..

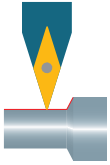

292

UTILIS **multidec**®
swiss type tools

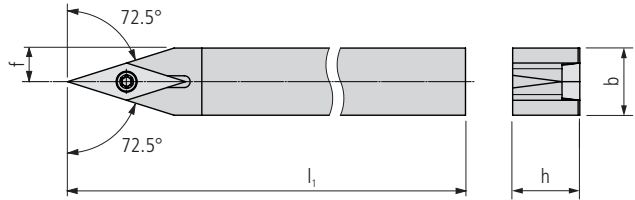

SVVCN ... U (72.5°)

Order designation		Dimensions							Inserts
N		h	b	l ₁		f		□ 259...	

STANDARD-LINE

SVVCN 0808 F11 U	■			8	8	80		4		VC..1103..
SVVCN 0808 H07 U	■			8	8	100		4		VC..0702..
SVVCN 0808 H11 U	■			8	8	100		4		VC..1103..
SVVCN 1010 F11 U	■			10	10	80		5		VC..1103..
SVVCN 1010 H07 U	■			10	10	100		5		VC..0702..
SVVCN 1010 H11 U	■			10	10	100		5		VC..1103..
SVVCN 1212 F11 U	■			12	12	80		6		VC..1103..
SVVCN 1212 H07 U	■			12	12	100		6		VC..0702..
SVVCN 1212 H11 U	■			12	12	100		6		VC..1103..
SVVCN 1616 K11 U	■			16	16	125		8		VC..1103..
SVVCN 2020 K11 U	■			20	20	125		10		VC..1103..
SVVCN 2020 K16 U	■			20	20	125		10		VC..1604..

SVVCN ... U (72.5°) INCH

Order designation		Dimensions							Inserts
L R		h	b	l ₁		f		□ 259...	

STANDARD-LINE

SVVCN 3/8" H07 U	■			9.525	9.525	100		4.76		VC..0702..
SVVCN 3/8" H11 U	■			9.525	9.525	100		4.76		VC..1103..
SVVCN 1/2" H07 U	■			12.7	12.7	100		6.35		VC..0702..
SVVCN 1/2" H11 U	■			12.7	12.7	100		6.35		VC..1103..
SVVCN 5/8" K11 U	■			15.875	15.875	125		7.93		VC..1103..
SVVCN 3/4" K11 U	■			19.05	19.05	125		9.525		VC..1103..
SVVCN 3/4" K16 U	■			19.05	19.05	125		9.525		VC..1604..

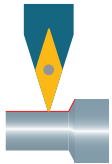

With internal cooling

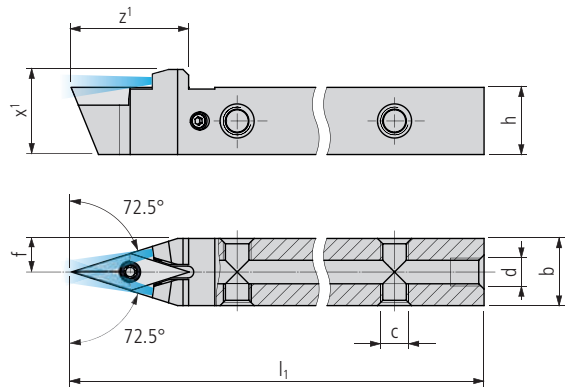

SVVCN ... U IC (72.5°)

Order designation		Dimensions									Inserts
L	R	h	b	l ₁	z ¹	x ¹	c	d	f	□ 259...	

PREMIUM-LINE

SVVCN 0808 H07 U IC	■		8	8	100	20	11.5	M5	M5	4	VC..0702..
SVVCN 0810 H11 U IC	■		8	10	100	21	13.2	M5	M5	5	VC..1103..
SVVCN 1010 H07 U IC	■		10	10	100	20	13.5	M5	M5	5	VC..0702..
SVVCN 1010 H11 U IC	■		10	10	100	21	13.2	M5	M5	5	VC..1103..
SVVCN 1212 H07 U IC	■		12	12	100	20	15.5	M5	M5	6	VC..0702..
SVVCN 1212 H11 U IC	■		12	12	100	21	15.2	M5	M5	6	VC..1103..
SVVCN 1616 K11 U IC	■		16	16	125	21	19.2	M5	G ¹ / ₈ "	8	VC..1103..
SVVCN 2020 K11 U IC	■		20	20	125	21	23.2	M5	G ¹ / ₈ "	10	VC..1103..
SVVCN 2020 K16 U IC	■		20	20	125	27	24.2	M5	G ¹ / ₈ "	10	VC..1604..

SVVCN ... U IC (72.5°) INCH

Order designation		Dimensions									Inserts
L	R	h	b	l ₁	z ¹	x ¹	c	d	f	□ 259...	

PREMIUM-LINE

SVVCN 3/8" H07 U IC	■		9.525	9.525	100	20	13	M5	M5	4.76	VC..0702..
SVVCN 3/8" H11 U IC	■		9.525	9.525	100	21	12.7	M5	M5	4.76	VC..1103..
SVVCN 1/2" H07 U IC	■		12.7	12.7	100	20	16.2	M5	M5	6.35	VC..0702..
SVVCN 1/2" H11 U IC	■		12.7	12.7	100	21	15.9	M5	M5	6.35	VC..1103..
SVVCN 5/8" K11 U IC	■		15.875	15.875	125	21	19.1	M5	G ¹ / ₈ "	7.94	VC..1103..
SVVCN 3/4" K11 U IC	■		19.05	19.05	125	21	22.3	M5	G ¹ / ₈ "	9.52	VC..1103..
SVVCN 3/4" K16 U IC	■		19.05	19.05	125	27	23.3	M5	G ¹ / ₈ "	9.52	VC..1604..

Scope of delivery: Holder without coolant connector
 Coolant system □ 619...

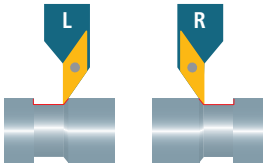

294

UTILIS **multidec**®
swiss type tools

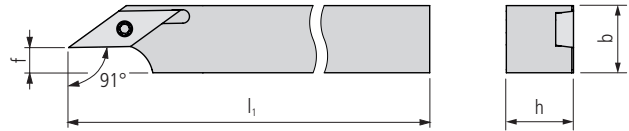
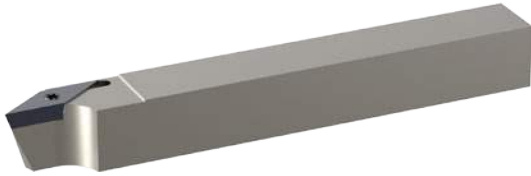

SVXC... U (91°)

Order designation		Dimensions							Inserts
L	R	h	b	l ₁		f		□ 259...	

STANDARD-LINE

SVXCL 0808 H07 U	■	SVXCR 0808 H07 U	■	8	8	100		2.5			VC..0702..
SVXCL 1010 F11 U	■	SVXCR 1010 F11 U	■	10	10	80		2.5			VC..1103..
SVXCL 1010 H07 U	■	SVXCR 1010 H07 U	■	10	10	100		4.5			VC..0702..
SVXCL 1010 H11 U	■	SVXCR 1010 H11 U	■	10	10	100		2.5			VC..1103..
SVXCL 1212 H07 U	■	SVXCR 1212 H07 U	■	12	12	100		6.5			VC..0702..
SVXCL 1212 H11 U	■	SVXCR 1212 H11 U	■	12	12	100		4.5			VC..1103..
SVXCL 1616 K11 U	■	SVXCR 1616 K11 U	■	16	16	125		8.5			VC..1103..
SVXCL 2020 K16 U	■	SVXCR 2020 K16 U	■	20	20	125		8.5			VC..1604..

SVXC... U (91°) INCH

Order designation		Dimensions							Inserts
L	R	h	b	l ₁		f		□ 259...	

STANDARD-LINE

SVXCL 3/8" F11 U	■	SVXCR 3/8" F11 U	■	9.525	9.525	80		2			VC..1103..
SVXCL 3/8" H07 U	■	SVXCR 3/8" H07 U	■	9.525	9.525	100		4			VC..0702..
SVXCL 3/8" H11 U	■	SVXCR 3/8" H11 U	■	9.525	9.525	100		2			VC..1103..
SVXCL 1/2" H07 U	■	SVXCR 1/2" H07 U	■	12.7	12.7	100		7.2			VC..0702..
SVXCL 1/2" H11 U	■	SVXCR 1/2" H11 U	■	12.7	12.7	100		5.2			VC..1103..
SVXCL 5/8" K11 U	■	SVXCR 5/8" K11 U	■	15.875	15.875	125		8.3			VC..1103..
SVXCL 3/4" K16 U	■	SVXCR 3/4" K16 U	■	19.05	19.05	125		7.5			VC..1604..

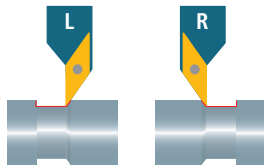

With internal cooling

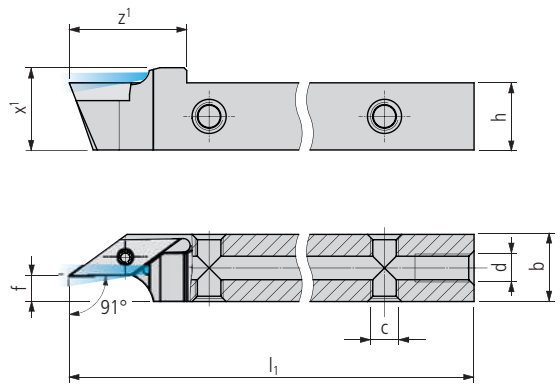

SVXC... U IC (91°)

Order designation		Dimensions										Inserts
L	R	h	b	l ₁	z ¹	x ¹	c	d	f	□ 259...		

PREMIUM-LINE

SVXCL 0808 H07 U IC	■	SVXCR 0808 H07 U IC	■	8	8	100	18	11.5	M5	M5	2.5	VC..0702..
SVXCL 1010 F11 U IC	■	SVXCR 1010 F11 U IC	■	10	10	80	21	12.7	M5	M5	3	VC..1103..
SVXCL 1010 H07 U IC	■	SVXCR 1010 H07 U IC	■	10	10	100	18	13.5	M5	M5	4.5	VC..0702..
SVXCL 1010 H11 U IC	■	SVXCR 1010 H11 U IC	■	10	10	100	21	12.7	M5	M5	3	VC..1103..
SVXCL 1212 H07 U IC	■	SVXCR 1212 H07 U IC	■	12	12	100	18	15.5	M5	M5	6.5	VC..0702..
SVXCL 1212 H11 U IC	■	SVXCR 1212 H11 U IC	■	12	12	100	21	14.7	M5	M5	5	VC..1103..
SVXCL 1616 K11 U IC	■	SVXCR 1616 K11 U IC	■	16	16	125	21	18.7	M5	G ¹ / ₈ "	9	VC..1103..
SVXCL 2020 K16 U IC	■	SVXCR 2020 K16 U IC	■	20	20	125	27	22	M5	G ¹ / ₈ "	9	VC..1604..

SVXC... U IC (91°) INCH

Order designation		Dimensions										Inserts
L	R	h	b	l ₁	z ¹	x ¹	c	d	f	□ 259...		

PREMIUM-LINE

SVXCL 3/8" F11 U IC	■	SVXCR 3/8" F11 U IC	■	9.525	9.525	80	21	12.2	M5	M5	2	VC..1103..
SVXCL 3/8" H07 U IC	■	SVXCR 3/8" H07 U IC	■	9.525	9.525	100	18	13	M5	M5	4.02	VC..0702..
SVXCL 3/8" H11 U IC	■	SVXCR 3/8" H11 U IC	■	9.525	9.525	100	21	12.2	M5	M5	2	VC..1103..
SVXCL 1/2" H07 U IC	■	SVXCR 1/2" H07 U IC	■	12.7	12.7	100	18	16.2	M5	M5	7.19	VC..0702..
SVXCL 1/2" H11 U IC	■	SVXCR 1/2" H11 U IC	■	12.7	12.7	100	21	15.4	M5	M5	5	VC..1103..
SVXCL 5/8" K11 U IC	■	SVXCR 5/8" K11 U IC	■	15.875	15.875	125	21	18.6	M5	G ¹ / ₈ "	8	VC..1103..
SVXCL 3/4" K16 U IC	■	SVXCR 3/4" K16 U IC	■	19.05	19.05	125	27	22	M5	G ¹ / ₈ "	8	VC..1604..

Scope of delivery: Holder without coolant connector
 Coolant system □ 619...

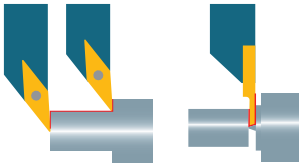

"TWIN" version

296

UTILIS **multidec**®
 SWISS type tools

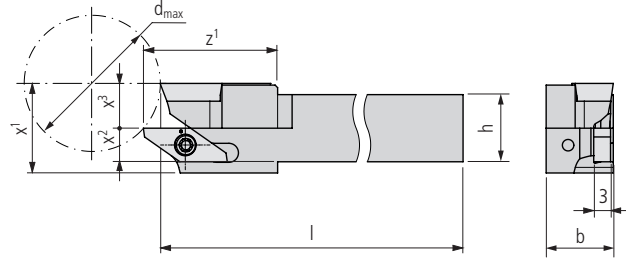

SVJC. (93°)/1600... TWIN

Order designation	Dimensions								Inserts	
	h	b	l	z ¹	x ¹	x ²	x ³	d _{max}	□259...	□49...
										

STANDARD-LINE

SVJCR/1600R-0810 H07 Twin	■	8	10	100	24	16	4	8	24	VC..0702..	16...
SVJCR/1600R-1010 H07 Twin	■	10	10	100	24	16	5	8	24	VC..0702..	16...
SVJCR/1600R-1212 H07 Twin	■	12	12	100	24	16	6	8	24	VC..0702..	16...
SVJCR/1600R-0810 H11 Twin	■	8	10	100	24	16	4	8	24	VC..1103..	16...
SVJCR/1600R-1010 H11 Twin	■	10	10	100	24	16	5	8	24	VC..1103..	16...
SVJCR/1600R-1212 H11 Twin	■	12	12	100	24	16	6	8	24	VC..1103..	16...
SVJCR/1600R-1616 K11 Twin	■	16	16	125	24	20	8	10	36	VC..1103..	16...
SVJCR/1600R-2020 K11 Twin	■	20	20	125	24	24	8	14	68	VC..1103..	16...

SVJC. (93°)/1600... TWIN INCH

Order designation	Dimensions								Inserts	
	h	b	l	z ¹	x ¹	x ²	x ³	d _{max}	□259...	□49...
										

STANDARD-LINE

SVJCR/1600R-3/8" H07 Twin	■	9.525	9.525	100	24	16	4.76	8	24	VC..0702..	16...
SVJCR/1600R-1/2" H07 Twin	■	12.7	12.7	100	24	16	6.35	8	24	VC..0702..	16...
SVJCR/1600R-3/8" H11 Twin	■	9.525	9.525	100	24	16	4.76	8	24	VC..1103..	16...
SVJCR/1600R-1/2" H11 Twin	■	12.7	12.7	100	24	16	6.35	8	24	VC..1103..	16...
SVJCR/1600R-5/8" K11 Twin	■	15.875	15.875	125	24	20	7.94	10	36	VC..1103..	16...
SVJCR/1600R-3/4" K11 Twin	■	19.05	19.05	125	24	24	7.53	14	68	VC..1103..	16...

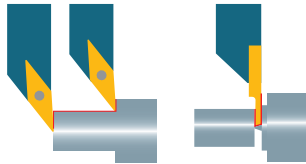

"TWIN" version with internal cooling

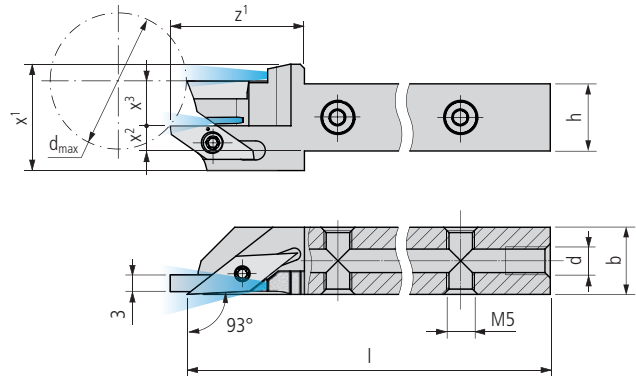

SVJC. (93°)/1600... TWIN IC

Order designation	Dimensions									Inserts	
	h	b	l	z ¹	x ¹	x ²	x ³	d	d _{max}	□ 259...	□ 49...

PREMIUM-LINE

	SVJCR/1600R-0810 H07 Twin IC	■	8	10	100	24	19	2.5	8	M5	24	VC..0702..	16...
	SVJCR/1600R-1010 H07 Twin IC	■	10	10	100	24	19	3.5	8	M5	24	VC..0702..	16...
	SVJCR/1600R-1212 H07 Twin IC	■	12	12	100	24	19	4.5	8	M5	24	VC..0702..	16...
	SVJCR/1600R-0810 H11 Twin IC	■	8	10	100	24	19	2.5	8	M5	24	VC..1103..	16...
	SVJCR/1600R-1010 H11 Twin IC	■	10	10	100	24	19	3.5	8	M5	24	VC..1103..	16...
	SVJCR/1600R-1212 H11 Twin IC	■	12	12	100	24	19	4.5	8	M5	24	VC..1103..	16...
	SVJCR/1600R-1616 K11 Twin IC	■	16	16	125	24	23	6.5	10	G1/8"	36	VC..1103..	16...
	SVJCR/1600R-2020 K11 Twin IC	■	20	20	125	24	27	6.5	14	G1/8"	68	VC..1103..	16...

SVJC. (93°)/1600... TWIN IC INCH

Order designation	Dimensions									Inserts	
	h	b	l	z ¹	x ¹	x ²	x ³	d	d _{max}	□ 259...	□ 49...

PREMIUM-LINE

	SVJCR/1600R-3/8" H07 Twin IC	■	9.525	9.525	100	24	19	3.26	8	M5	24	VC..0702..	16...
	SVJCR/1600R-1/2" H07 Twin IC	■	12.7	12.7	100	24	19	4.85	8	M5	24	VC..0702..	16...
	SVJCR/1600R-3/8" H11 Twin IC	■	9.525	9.525	100	24	19	3.26	8	M5	24	VC..1103..	16...
	SVJCR/1600R-1/2" H11 Twin IC	■	12.7	12.7	100	24	19	4.85	8	M5	24	VC..1103..	16...
	SVJCR/1600R-5/8" K11 Twin IC	■	15.875	15.875	125	24	23	6.44	10	G1/8"	36	VC..1103..	16...
	SVJCR/1600R-3/4" K11 Twin IC	■	19.05	19.05	125	24	27	6.03	14	G1/8"	68	VC..1103..	16...

Scope of delivery: Holder without coolant connector
 Coolant system 619...

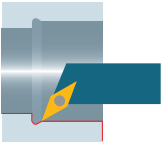

298

UTILIS **multidec**® swiss type tools

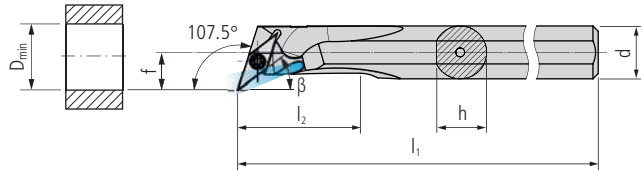

A... SVQC... (107.5°)

Order designation		Dimensions									Inserts
L	R	d	h	l ₁	l ₂	f	D _{min}	β		□ 259...	

STANDARD-LINE

A10 H SVQCL 07	■	A10 H SVQCR 07	■	10	9.5	100	23	8	16	37.5°	VC..0702..
A12 K SVQCL 07	■	A12 K SVQCR 07	■	12	11.5	125	25	9	17	37.5°	VC..0702..
A16 M SVQCL 07	■	A16 M SVQCR 07	■	16	15	150	29	11	20	37.5°	VC..0702..
A16M SVQCL 11	■	A16M SVQCR 11	■	16	15	150	29	11	20	37.5°	VC..1103..
A20Q SVQCL 11	■	A20Q SVQCR 11	■	20	18.5	180	32	13	25	37.5°	VC..1103..

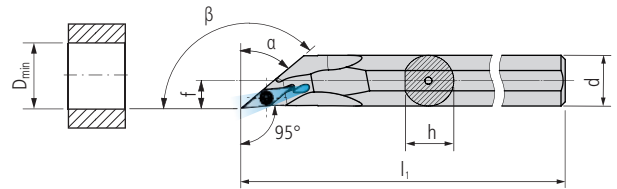

A... SVOC... (95°)

Order designation		Dimensions								Inserts
L	R	d	h	l ₁	f	D _{min}	α	β	□ 259...	

STANDARD-LINE

A10 H SVOCL 07	■	A10 H SVOCR 07	■	10	9.5	100	5.5	11	50°	140°	VC..07..
A12 K SVOCL 07	■	A12 K SVOCR 07	■	12	11.5	125	6.5	13	50°	140°	VC..07..
A12K SVOCL 11	■	A12K SVOCR 11	■	12	11.5	125	7	17	50°	140°	VC..11..
A16 M SVOCL 07	■	A16 M SVOCR 07	■	16	15.5	150	8.5	17	50°	140°	VC..07..
A16M SVOCL 11	■	A16M SVOCR 11	■	16	15.5	150	9	20	50°	140°	VC..11..

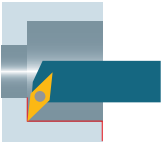

300

UTILIS
 multidec®
 swiss type tools

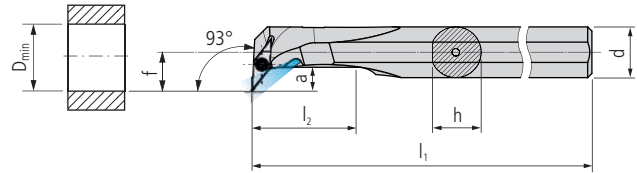

A... SVUC... (93°)

Order designation		Dimensions								Inserts
L	R	d	h	l ₁	l ₂	f	D _{min}	a	□ 259...	

STANDARD-LINE

A10 H SVUCL 07	■	A10 H SVUCR 07	■	10	9.5	100	23	8.5	13.5	5	VC..0702..
A12 K SVUCL 07	■	A12 K SVUCR 07	■	12	11.5	125	25	9	17	5.5	VC..0702..
A16 M SVUCL 07	■	A16 M SVUCR 07	■	16	15.5	150	36	11	20	5.5	VC..0702..
A16 M SVUCL 11	■	A16 M SVUCR 11	■	16	15.5	150	36	13	21	8	VC..1103..
A20 Q SVUCL 11	■	A20 Q SVUCR 11	■	20	19.5	180	40	14	24	8	VC..1103..

For holders (SV...) OD turning

Illustration	Description	Dimensions	Order designation	Holder
	TORX screw	M2 × 5.5 T06	MSP 20055 T06	■ SV... 07
		M2.5 × 6 T08	MSP 25060 T08	■ SV... 11
		M3.5 × 11 T15	MSP 35110 T15	■ SV... 16

For holders (... SV...) ID turning

Illustration	Description	Dimensions	Order designation	Holder
	TORX screw	M2 × 5.5 T06	MSP 20055 T06	■ A... SV... 07
		M2.5 × 6 T08	MSP 25060 T08	■ A... SV... 11

TORX screwdriver 651...

	Aluminum			Brass			Hard materials		
Hardness value (HB)/(HRC)	60–130 HB			–			45–70 HRC		
Category	VII			VIII			X		
Machining method	▼	▼▼	▼▼▼	▼	▼▼	▼▼▼	▼	▼▼	▼▼▼
Cutting speeds	v_c (m/min)								
Cutting material carbide									
UHM 10	100–1500	120–2000	160–2500	80–300	100–400	120–500	–	–	–
UHM 10 HX	140–2500	160–3000	200–3000	100–450	100–600	100–750	–	–	–
UHM 10 TX+	–	–	–	–	–	–	15–30	15–40	20–60
UHM 10 MZ	–	–	–	–	–	–	–	–	–
UHM 20 HPX	–	–	–	–	–	–	–	–	–
UHM 20 TX+	–	–	–	–	–	–	–	–	–
UHM 20 MZ	–	–	–	–	–	–	–	–	–
UHM 30	50–1000	60–1200	80–1500	40–100	50–140	50–160	–	–	–
UHM 30 HX	70–1500	80–2000	100–3000	50–150	50–200	50–250	–	–	–
UHM 30 TX+	–	–	–	–	–	–	–	–	–
UHM 30 MZ	–	–	–	–	–	–	–	–	–
UHM 30 SX	60–1200	80–2000	100–3000	50–120	50–180	50–200	–	–	–
Cutting material cermet									
UCM 10	–	–	–	–	–	–	–	–	–
UCM 10 HX	–	–	–	–	–	–	–	–	–
Cutting material diamond									
UCVD 08	–	300–2000	300–3000	–	250–1000	300–1500	–	–	–
UPCD 15	–	300–2000	300–3000	–	250–1000	300–1500	–	–	–
UPCD 20	–	300–2000	300–3000	–	250–1000	300–1500	–	–	–

Feed (f) and depths of cut (a_p) 178...

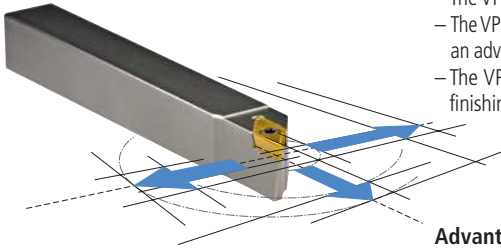

The "TOP" system with drag-cut permits an increase of the feed rate of up to 100 % compared to conventional ISO inserts.

- The VPGT 1003... F provides a sharp cutting edge for semi-finishing, finishing and micro-finishing.
- The VPET 1003... F provides a sharp cutting edge and the tolerance of its insert height is more precise. This is an advantage as the height does not have to be reset when changing the insert.
- The VPXT 1003... E is a directly pressed insert with rounded cutting edge for roughing and semi-finishing.

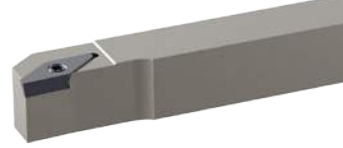

Advantages:

- Front turning, back turning and facing with one insert
- Carbide grades and coatings for steel, stainless steel and superalloys
- Cutting edge radius from 0 to 0.35 mm available as standard
- Heat-treated holders and boring bars
- Reinforced "V" type holders for front turning with high depths of cut



"IC" tool holder with integrated cooling

Cost-efficient processing of modern materials increasingly requires accurate control of the coolant at the cutting edge. Conveying the coolant as close as possible to the cutting edge is often a difficult task in the machine rooms of Swiss type turning lathes.

The multidec®-IC program offers a wide range of holders with integrated cooling. Because of the high precision and pressure, it is possible to discharge the chip quickly and safely from the cutting edge and the workpiece, which protects the cutting edge of the insert. This means significantly longer tool life as well as very reliable serial production.

Advantages:

- All holders feature five possible connectors for the coolant supply
- Constant coolant discharge means low build-up at front near the holder
- With or without high pressure, the coolant medium always hits the cutting edge precisely



"TWIN" holder with and without integrated coolant supply

The "TWIN" range allows you to work with two inserts on the same holder. Different combinations are possible, and provide the user with a high degree of flexibility. Holders are available with shank cross-sections of 8 to 20 mm, with and without internal cooling.

Advantages:

- Twice the number of tools on the machine
- Two different turning operations are possible with a single tool holder
- All holders with an integrated coolant supply have five connecting options



"Y-AXIS" holder with and without integrated coolant supply

Y-AXIS holders solve the chip control problems that can occur when cutting long-chip materials. With the Y-AXIS holder, the cutting edge is offset by 90° compared to the standard holder, whereby the chips fall in the bed of the machine. This prevents troublesome tumbling and flowing chips that can become caught on the cutting edge and damage it.

Benefits:

- Suitable for long chipping materials
- The problem of chip control is solved
- Holders with internal cooling
- All holders feature five possible connectors for the coolant supply









"FC" holder with quick cutting edge change system (fast change)

The cutting edge can be changed without unclamping the holder using the "FC" holder. The indexable insert is mounted using a specially developed knee lever which is operated using a clamping screw on the rear of the holder.

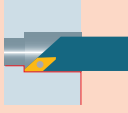
Advantages:

- Quick indexable insert change directly in the machine
- Holder with and without integrated coolant supply

Overview – multidec®-TOP, type VP... (35°)

Technical information		11																		
Application OD turning		306																		
Application ID turning		306																		
Inserts (carbide)																				
VPET ... TOP		307																		
VPGT ... TOP		308																		
VPXT ... TOP		309																		
Holder (OD turning)																				
SVAP... (90°)		311																		
SVJP... (93°), SVJP... IC (93°)		312																		
SVJP... V (93°), SVJP... V IC (93°)		314																		
SVJP... FC (93°), SVJP... FC IC (93°)		316																		
SVJP... V FC (93°), SVJP... V FC IC (93°)		318																		
SVXP... (91°), SVXP... IC (91°)		320																		
SVJP. (93°)/1600... TWIN, SVJP. (93°)/1600... IC TWIN		322																		
SVJP.YA... (93°) Y-AXIS		326																		
Holder (ID turning)																				
SVJP... (92°)		327																		
A... SVJP... (92°)		328																		
SVQP... (92°)		329																		
SVUP... (92°)		330																		
Replacement and spare parts		331																		
Cutting specification	<table border="1"> <thead> <tr> <th></th> <th>Spit-voeding Met een olie of een droog slijfmiddel</th> <th>Spit-voedingen Met een olie of een droog slijfmiddel</th> <th>Spit-voeding Met een olie of een droog slijfmiddel</th> <th>Spit-voeding Met een olie of een droog slijfmiddel</th> <th>Spit-voeding Met een olie of een droog slijfmiddel</th> </tr> </thead> <tbody> <tr> <td>Materiaal Diameter Lengte Lengte Lengte</td> <td>125-200</td> <td>160-200</td> <td>200-250</td> <td>200-250</td> <td>-</td> </tr> <tr> <td>Gebruik Gebruik Gebruik Gebruik Gebruik</td> <td>✓</td> <td>✓</td> <td>✓</td> <td>✓</td> <td>✓</td> </tr> </tbody> </table>		Spit-voeding Met een olie of een droog slijfmiddel	Spit-voedingen Met een olie of een droog slijfmiddel	Spit-voeding Met een olie of een droog slijfmiddel	Spit-voeding Met een olie of een droog slijfmiddel	Spit-voeding Met een olie of een droog slijfmiddel	Materiaal Diameter Lengte Lengte Lengte	125-200	160-200	200-250	200-250	-	Gebruik Gebruik Gebruik Gebruik Gebruik	✓	✓	✓	✓	✓	332
	Spit-voeding Met een olie of een droog slijfmiddel	Spit-voedingen Met een olie of een droog slijfmiddel	Spit-voeding Met een olie of een droog slijfmiddel	Spit-voeding Met een olie of een droog slijfmiddel	Spit-voeding Met een olie of een droog slijfmiddel															
Materiaal Diameter Lengte Lengte Lengte	125-200	160-200	200-250	200-250	-															
Gebruik Gebruik Gebruik Gebruik Gebruik	✓	✓	✓	✓	✓															
Special tools – multidec4you®		600																		
Coolant system and accessories		619																		

Front turning

Holders 311

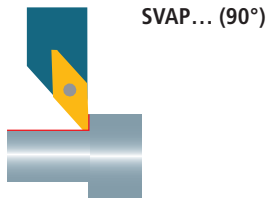

Turning and facing

Holders 312/314

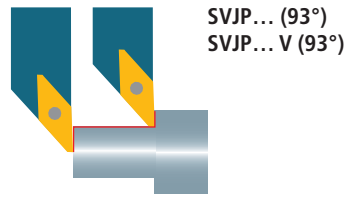

Back turning

Holders 320

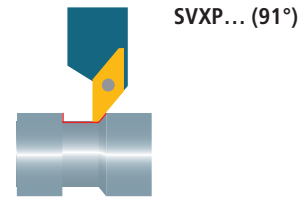

306

UTILIS
multidec
swiss type tools

Turning and facing

Holders 327/328

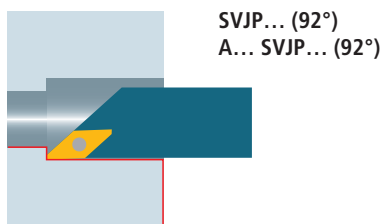

Back turning

Holders 329

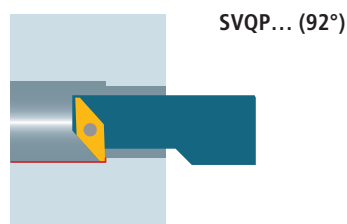

Turning and facing

Holders 330

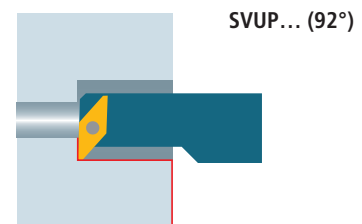

Inserts 307

All illustrations show right hand design. Left hand design is also available.

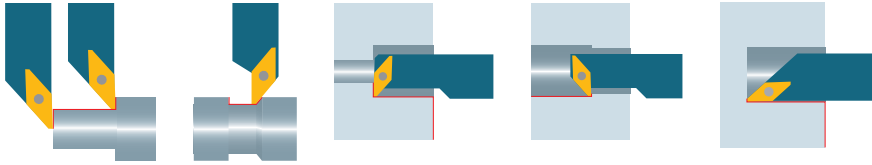

VPET ... -TOP*

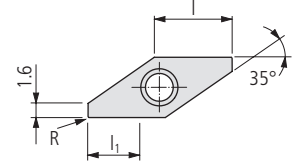

β : 12°
s: ±0.025
C: <0.002

Order designation	Carbide													Cermet	Diamond	Dimensions			Holder □311...				
	UHM 10	UHM 10 HX	UHM 10 TX+	UHM 10 MZ	UHM 20	UHM 20 HPX	UHM 20 TX+	UHM 20 MZ	UHM 30	UHM 30 HX	UHM 30 TX+	UHM 30 MZ	UHM 30 SX			UCM 10	UCM 10 HX	UCM 10 MZ		UCVD 08	UPCD 15	UPCD 20	I
	-	-	●	●	○	●	●	○	○	○	○	○	○	○	○	○	○	○	○	○	○	○	○
	○	○	○	○	○	○	○	○	○	○	○	○	○	○	○	○	○	○	○	○	○	○	○
	○	○	-	-	-	-	-	-	-	-	-	-	-	-	-	-	-	-	-	-	-	-	-
	○	○	○	○	○	○	○	○	○	○	○	○	○	○	○	○	○	○	○	○	○	○	○

PREMIUM-LINE

L	R	VPET 1003ZZ FL -TOP ...	VPET 1003008 FL -TOP ...	VPET 1003015 FL -TOP ...	VPET 1003ZZ FR -TOP ...	VPET 1003005 FR -TOP ...	VPET 1003008 FR -TOP ...	VPET 1003015 FR -TOP ...	I	R	I ₁	Holder
		●	●	●	●	●	●	●	●	8.9	0	4.5
●	●	●	●	●	●	●	●	8.9	0.08	4.5	SV.....	
●	●	●	●	●	●	●	●	8.9	0.15	4.5	SV.....	
●	●	●	●	●	●	●	●	8.9	0	4.5	SV.....	
●	●	●	●	●	●	●	●	8.9	0.05	4.5	SV.....	
●	●	●	●	●	●	●	●	8.9	0.08	4.5	SV.....	
●	●	●	●	●	●	●	●	8.9	0.15	4.5	SV.....	

* Description TOP □13

Application range of chip breaker

Properties:

- polished rake and ground clearance
- sharp cutting edge "F"
- submicrograin carbide, high toughness
- TOP system, for a better surface finish
- closer tolerance "E"

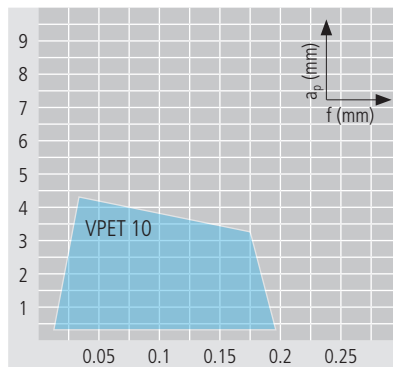

Optimal chip breaking

Application:

- finishing for 20–100 % higher feed rates compared to the standard
- chip breaker for general application
- stainless steel, alloyed steel and super alloy

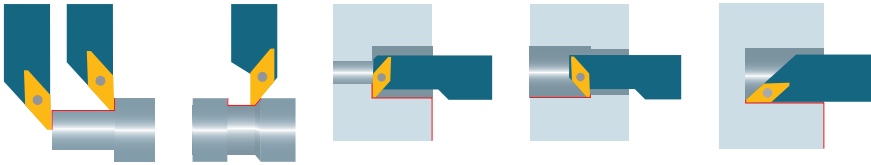

308

UTILIS
multidec
swiss type tools



VPGT ... -TOP*

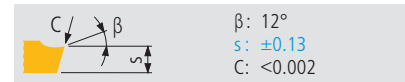
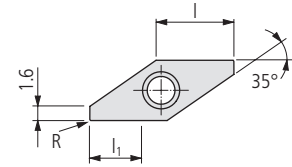

Order designation	Carbide												C20		Cermet		Diamond		Dimensions			Holder	
	UHM 10	UHM 10 HX	UHM 10 TX+	UHM 10 MZ	UHM 20	UHM 20 HPX	UHM 20 TX+	UHM 20 MZ	UHM 30	UHM 30 HX	UHM 30 TX+	UHM 30 MZ	UHM 30 SX	UCM 10	UCM 10 HX	UCM 10 MZ	UCVD 08	UPCD 15	UPCD 20	I	R	I ₁	□ 311...
	-	-	●	●	○	●	●	○	○	○	○	○	○	○	○	○	-	-	-	8.9	0	4.5	SV.....
	-	-	●	●	○	●	●	○	○	○	○	○	○	○	○	○	-	-	-	8.9	0.08	4.5	SV.....
	○	○	-	-	-	-	-	-	-	-	-	-	-	-	-	-	-	-	8.9	0.15	4.5	SV.....	
	-	-	●	●	-	-	-	-	-	-	-	-	-	-	-	-	-	-	8.9	0	4.5	SV.....	
	-	-	○	○	-	-	-	-	-	-	-	-	-	-	-	-	-	-	8.9	0.05	4.5	SV.....	
	-	-	○	○	-	-	-	-	-	-	-	-	-	-	-	-	-	-	8.9	0.08	4.5	SV.....	
	-	-	○	○	-	-	-	-	-	-	-	-	-	-	-	-	-	-	8.9	0.15	4.5	SV.....	

STANDARD-LINE

L	VPGT 1003ZZ FL-TOP ...	■	■	■	■	■	■	■	■	■	■	■	■	■	■	■	■	■	8.9	0	4.5	SV.....
	VPGT 1003008 FL-TOP ...	■	■	■	■	■	■	■	■	■	■	■	■	■	■	■	■	■	8.9	0.08	4.5	SV.....
	VPGT 1003015 FL-TOP ...	■	■	■	■	■	■	■	■	■	■	■	■	■	■	■	■	■	8.9	0.15	4.5	SV.....
R	VPGT 1003ZZ FR-TOP ...	■	■	■	■	■	■	■	■	■	■	■	■	■	■	■	■	■	8.9	0	4.5	SV.....
	VPGT 1003005 FR-TOP ...	■	■	■	■	■	■	■	■	■	■	■	■	■	■	■	■	■	8.9	0.05	4.5	SV.....
	VPGT 1003008 FR-TOP ...	■	■	■	■	■	■	■	■	■	■	■	■	■	■	■	■	■	8.9	0.08	4.5	SV.....
	VPGT 1003015 FR-TOP ...	■	■	■	■	■	■	■	■	■	■	■	■	■	■	■	■	■	8.9	0.15	4.5	SV.....

* Description TOP □ 13

Application range of chip breaker

Properties:

- polished rake and ground clearance
- sharp cutting edge "F"
- submicrograin carbide, high toughness
- TOP system, for a better surface finish

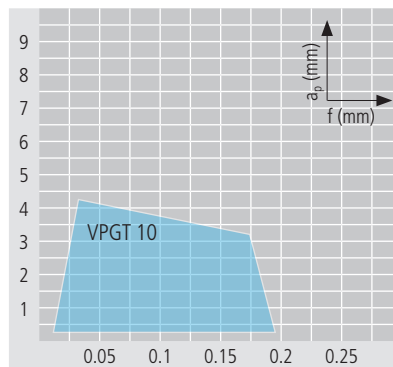

Optimal chip breaking

Application:

- finishing for 20-100 % higher feed rates compared to the standard
- chip breaker for general application
- stainless steel, alloyed steel and super alloy

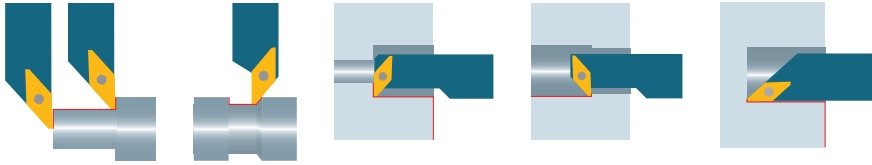

VPXT ... -TOP*

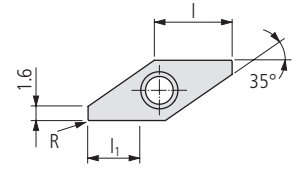

β : 12°
 s : ±0.1
 C : <0.02

Order designation	Carbide														Cermet		Diamond		Dimensions			Holder		
	UHM 10	UHM 10 HX	UHM 10 TX+	UHM 10 MZ	UHM 20	UHM 20 HPX	UHM 20 TX+	UHM 20 MZ	UHM 30	UHM 30 HX	UHM 30 TX+	UHM 30 MZ	UHM 30 SX	UCM 10	UCM 10 HX	UCM 10 MZ	UCVD 08	UPCD 15	UPCD 20	l	R	l ₁	□311...	
	-	-	●	●	○	●	●	○	○	○	○	○	○	○	○	○	○	○	○	○				
	○	○	○	○	○	○	○	○	○	○	○	○	○	○	○	○	○	○	○	○				
	○	○	-	-	-	-	-	-	-	-	-	-	-	-	-	-	-	-	-	-				
	-	-	●	●	○	○	○	○	○	○	○	○	○	○	○	○	○	○	○	○				

VALUE-LINE

L	VPXT 1003015 EL -TOP ...																							8.9	0.15	4.5	SV.....	
	VPXT 1003035 EL -TOP ...																								8.9	0.35	4.5	SV.....
R	VPXT 1003015 ER -TOP ...																								8.9	0.15	4.5	SV.....
	VPXT 1003035 ER -TOP ...																								8.9	0.35	4.5	SV.....

* Description TOP □ 13

Application range of chip breaker

- Properties:**
- high precision sintered insert
 - rounded cutting edge "E"
 - submicrograin carbide, high toughness and hardness
 - TOP system, for a better surface finish
 - best performance-cost ratio

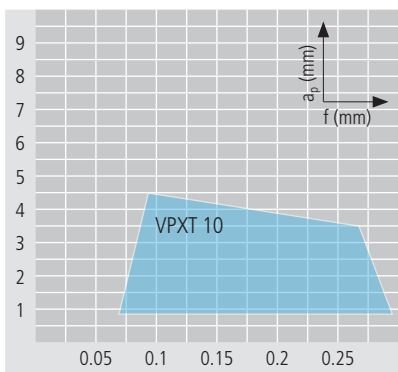

Optimal chip breaking

- Application:**
- finishing for 20-100% higher feed rates compared to the standard
 - chip breaker for general application
 - alloyed steel, stainless steel and super alloy

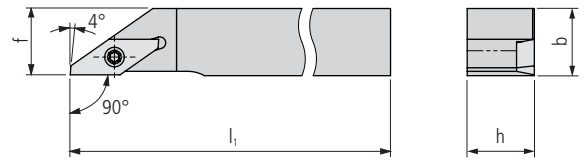

SVAP... (90°)

Order designation		Dimensions							Inserts
L	R	h	b	l ₁		f		□ 307...	

STANDARD-LINE

SVAPL 0707 H10	■	SVAPR 0707 H10	■	7	7	100		7		VP..1003..
SVAPL 0708 H10	■	SVAPR 0708 H10	■	7	8	100		8		VP..1003..
SVAPL 0808 F10	■	SVAPR 0808 F10	■	8	8	80		8		VP..1003..
SVAPL 0808 H10	■	SVAPR 0808 H10	■	8	8	100		8		VP..1003..
SVAPL 1010 F10	■	SVAPR 1010 F10	■	10	10	80		10		VP..1003..
SVAPL 1010 H10	■	SVAPR 1010 H10	■	10	10	100		10		VP..1003..
SVAPL 1212 H10	■	SVAPR 1212 H10	■	12	12	100		12		VP..1003..

SVAP... (90°) INCH

Order designation		Dimensions							Inserts
L	R	h	b	l ₁		f		□ 307...	

STANDARD-LINE

SVAPL 3/8" F10	■	SVAPR 3/8" F10	■	9.525	9.525	80		9.525		VP..1003..
SVAPL 3/8" H10	■	SVAPR 3/8" H10	■	9.525	9.525	100		9.525		VP..1003..
SVAPL 1/2" H10	■	SVAPR 1/2" H10	■	12.7	12.7	100		12.7		VP..1003..

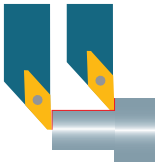

312

UTILIS **multidec**® swiss type tools

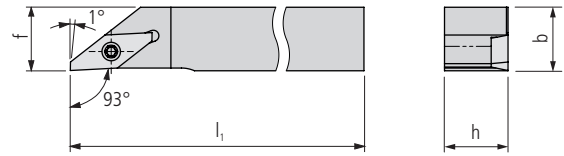
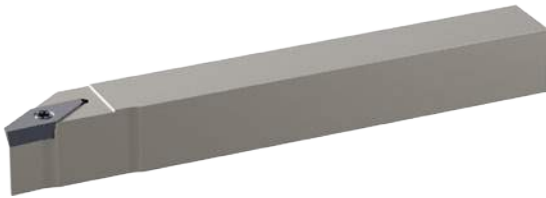

SVJP... (93°)

Order designation		Dimensions								Inserts
L	R	h	b	l ₁		f				□ 307...

STANDARD-LINE

SVJPL 0708 H10	■	SVJPR 0708 H10	■	7	8	100		8			VP..1003..
SVJPL 0808 F10	■	SVJPR 0808 F10	■	8	8	80		8			VP..1003..
SVJPL 0808 H10	■	SVJPR 0808 H10	■	8	8	100		8			VP..1003..
SVJPL 1010 F10	■	SVJPR 1010 F10	■	10	10	80		10			VP..1003..
SVJPL 1010 H10	■	SVJPR 1010 H10	■	10	10	100		10			VP..1003..
SVJPL 1212 H10	■	SVJPR 1212 H10	■	12	12	100		12			VP..1003..
SVJPL 1616 K10	■	SVJPR 1616 K10	■	16	16	125		16			VP..1003..
SVJPL 2020 K10	■	SVJPR 2020 K10	■	20	20	125		20			VP..1003..

SVJP... (93°) INCH

Order designation		Dimensions								Inserts
L	R	h	b	l ₁		f				□ 307...

STANDARD-LINE

SVJPL 3/8" F10	■	SVJPR 3/8" F10	■	9.525	9.525	80		9.525			VP..1003..
SVJPL 3/8" H10	■	SVJPR 3/8" H10	■	9.525	9.525	100		9.525			VP..1003..
SVJPL 1/2" H10	■	SVJPR 1/2" H10	■	12.7	12.7	100		12.7			VP..1003..
SVJPL 5/8" K10	■	SVJPR 5/8" K10	■	15.875	15.875	125		15.875			VP..1003..
SVJPL 3/4" K10	■	SVJPR 3/4" K10	■	19.05	19.05	125		19.05			VP..1003..

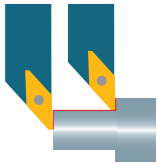

With internal cooling



SVJP... IC (93°)

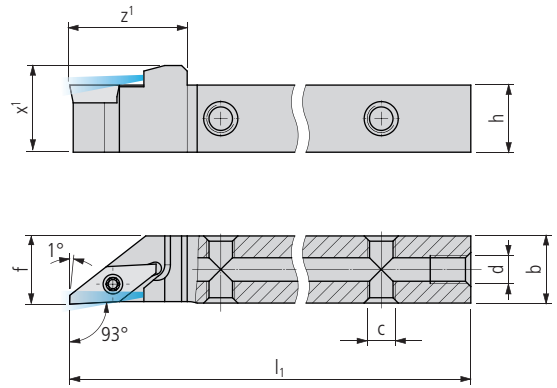

Order designation		Dimensions										Inserts
L	R	h	b	l ₁	z ¹	x ¹	c	d	f	□ 307...		

PREMIUM-LINE

SVJPL 0810 H10 IC	■	SVJPR 0810 H10 IC	■	8	10	100	21	11.5	M5	M5	10	VP..1003..
SVJPL 1010 H10 IC	■	SVJPR 1010 H10 IC	■	10	10	100	21	13.5	M5	M5	10	VP..1003..
SVJPL 1212 H10 IC	■	SVJPR 1212 H10 IC	■	12	12	100	21	15.5	M5	M5	12	VP..1003..
SVJPL 1616 K10 IC	■	SVJPR 1616 K10 IC	■	16	16	125	21	19.5	M5	G½"	16	VP..1003..
SVJPL 2020 K10 IC	■	SVJPR 2020 K10 IC	■	20	20	125	21	23.5	M5	G½"	20	VP..1003..

SVJP... IC (93°) INCH

Order designation		Dimensions										Inserts
L	R	h	b	l ₁	z ¹	x ¹	c	d	f	□ 307...		

PREMIUM-LINE

SVJPL 3/8" H10 IC	■	SVJPR 3/8" H10 IC	■	9.525	9.525	100	21	13	M5	M5	9.525	VP..1003..
SVJPL 1/2" H10 IC	■	SVJPR 1/2" H10 IC	■	12.7	12.7	100	21	16.2	M5	M5	12.7	VP..1003..
SVJPL 5/8" K10 IC	■	SVJPR 5/8" K10 IC	■	15.875	15.875	125	21	19.4	M5	G½"	15.875	VP..1003..
SVJPL 3/4" K10 IC	■	SVJPR 3/4" K10 IC	■	19.05	19.05	125	21	22.6	M5	G½"	19.05	VP..1003..

Scope of delivery: Holder without coolant connector

Coolant system □ 619...

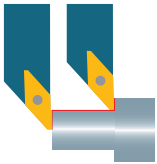

Strengthen type V

314

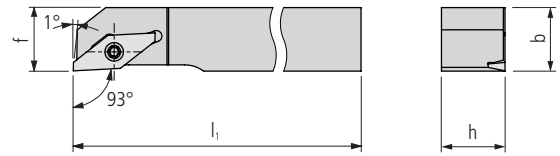

SVJP... V (93°)

Order designation		Dimensions								Inserts
L	R	h	b	l ₁		f				□ 307...

STANDARD-LINE

SVJPL 0810 F10 V	■	SVJPR 0810 F10 V	■	8	10	80		10			VP..1003..
SVJPL 0810 H10 V	■	SVJPR 0810 H10 V	■	8	10	100		10			VP..1003..
SVJPL 1010 F10 V	■	SVJPR 1010 F10 V	■	10	10	80		10			VP..1003..
SVJPL 1010 H10 V	■	SVJPR 1010 H10 V	■	10	10	100		10			VP..1003..
SVJPL 1212 H10 V	■	SVJPR 1212 H10 V	■	12	12	100		12			VP..1003..
SVJPL 1616 K10 V	■	SVJPR 1616 K10 V	■	16	16	125		16			VP..1003..
SVJPL 2020 K10 V	■	SVJPR 2020 K10 V	■	20	20	125		20			VP..1003..

SVJP... V (93°) INCH

Order designation		Dimensions								Inserts
L	R	h	b	l ₁		f				□ 307...

STANDARD-LINE

SVJPL 3/8" F10 V	■	SVJPR 3/8" F10 V	■	9.525	9.525	80		9.525			VP..1003..
SVJPL 3/8" H10 V	■	SVJPR 3/8" H10 V	■	9.525	9.525	100		9.525			VP..1003..
SVJPL 1/2" H10 V	■	SVJPR 1/2" H10 V	■	12.7	12.7	100		12.7			VP..1003..
SVJPL 5/8" K10 V	■	SVJPL 5/8" K10 V	■	15.875	15.875	125		15.875			VP..1003..
SVJPL 3/4" K10 V	■	SVJPL 3/4" K10 V	■	19.05	19.05	125		19.05			VP..1003..

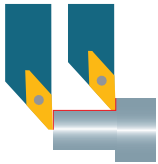

Strengthen type V with internal cooling

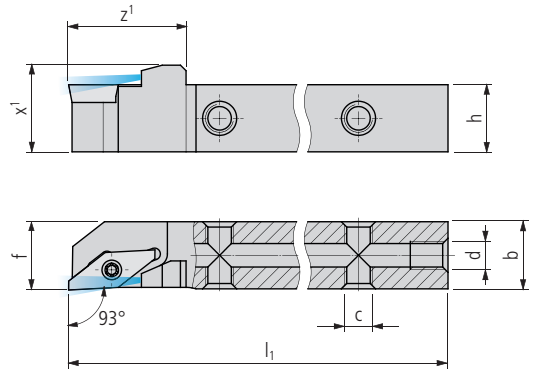

SVJPL... V IC (93°)

Order designation		Dimensions										Inserts
L	R	h	b	l ₁	z ¹	x ¹	c	d	f	□ 307...		

PREMIUM-LINE

SVJPL 0810 H10 V IC	■	SVJPR 0810 H10 V IC	■	8	10	100	21	11.5	M5	M5	10	VP..1003..
SVJPL 1010 H10 V IC	■	SVJPR 1010 H10 V IC	■	10	10	100	21	13.5	M5	M5	10	VP..1003..
SVJPL 1212 H10 V IC	■	SVJPR 1212 H10 V IC	■	12	12	100	21	15.5	M5	M5	12	VP..1003..
SVJPL 1616 K10 V IC	■	SVJPR 1616 K10 V IC	■	16	16	125	21	19.5	M5	G½"	16	VP..1003..
SVJPL 2020 K10 V IC	■	SVJPR 2020 K10 V IC	■	20	20	125	21	23.5	M5	G½"	20	VP..1003..

SVJPL... V IC (93°) INCH

Order designation		Dimensions										Inserts
L	R	h	b	l ₁	z ¹	x ¹	c	d	f	□ 307...		

PREMIUM-LINE

SVJPL 3/8" H10 V IC	■	SVJPR 3/8" H10 V IC	■	9.525	9.525	100	21	13	M5	M5	9.525	VP..1003..
SVJPL 1/2" H10 V IC	■	SVJPR 1/2" H10 V IC	■	12.7	12.7	100	21	16.2	M5	M5	12.7	VP..1003..
SVJPL 5/8" K10 V IC	■	SVJPR 5/8" K10 V IC	■	15.875	15.875	125	21	19.4	M5	G½"	15.875	VP..1003..
SVJPL 3/4" K10 V IC	■	SVJPR 3/4" K10 V IC	■	19.05	19.05	125	21	22.6	M5	G½"	19.05	VP..1003..

Scope of delivery: Holder without coolant connector

Coolant system □ 619...

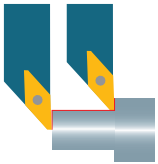

"FC" version (fast change)

316

UTILIS **multidec**® swiss type tools

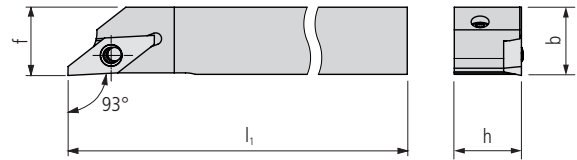

SVJP... FC* (93°)

Order designation		Dimensions								Inserts	
L	R	h	b	l ₁		f				□ 307...	
STANDARD-LINE											
SVJPL 1212 H10 FC	■	SVJPR 1212 H10 FC	■	12	12	100		12			VP..1003..
SVJPL 1616 K10 FC	■	SVJPR 1616 K10 FC	■	16	16	125		16			VP..1003..

SVJP... FC* (93°) INCH

Order designation		Dimensions								Inserts	
L	R	h	b	l ₁		f				□ 307...	
STANDARD-LINE											
SVJPL 1/2" H10 FC	■	SVJPR 1/2" H10 FC	■	12.7	12.7	100		12.7			VP..1003..
SVJPL 5/8" K10 FC	■	SVJPR 5/8" K10 FC	■	15.875	15.875	125		15.875			VP..1003..

Spare parts (clamping bolts/screws) □ 331

* Note

With this holder, the indexable insert is secured with a screw using a knee lever that can be operated from behind. This means the holder does not have to be unclamped to change the cutting edge.
 Tighten the clamping screw to 1.2 Nm using a torque screwdriver.

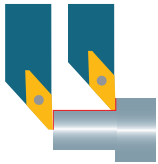

"FC" version (fast change) with internal cooling

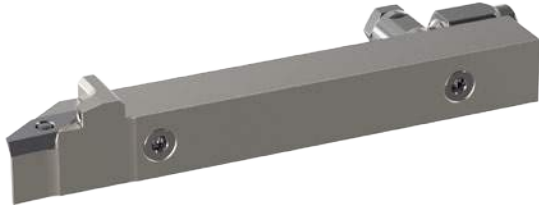

SVJP... FC* IC (93°)

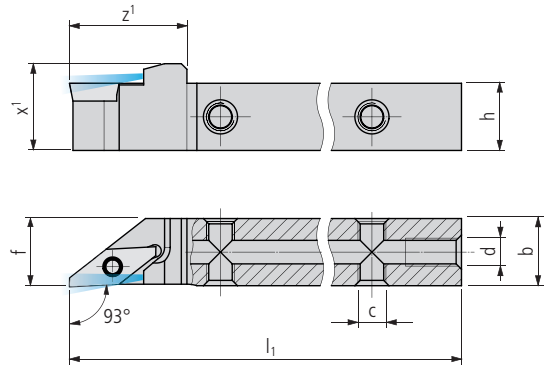

Order designation		Dimensions										Inserts
L	R	h	b	l ₁	z ¹	x ¹	c	d	f	□ 307...		
PREMIUM-LINE												
SVJPL 1212 H10 FC IC	■	SVJPR 1212 H10 FC IC	■	12	12	100	21	15.5	M5	M5	12	VP..1003..
SVJPL 1616 K10 FC IC	■	SVJPR 1616 K10 FC IC	■	16	16	125	21	19.5	M5	G½"	16	VP..1003..

SVJP... FC* IC (93°) INCH

Order designation		Dimensions										Inserts
L	R	h	b	l ₁	z ¹	x ¹	c	d	f	□ 307...		
PREMIUM-LINE												
SVJPL 1/2" H10 FC IC	■	SVJPR 1/2" H10 FC IC	■	12.7	12.7	100	21	16.2	M5	M5	12.7	VP..1003..
SVJPL 5/8" K10 FC IC	■	SVJPR 5/8" K10 FC IC	■	15.875	15.875	125	21	19.4	M5	G½"	15.875	VP..1003..

Spare parts (clamping bolts/screws) □ 331

* Note

With this holder, the indexable insert is secured with a screw using a knee lever that can be operated from behind. This means the holder does not have to be unclamped to change the cutting edge.
 Tighten the clamping screw to 1.2 Nm using a torque screwdriver.

Scope of delivery: Holder without coolant connector
 Coolant system □ 619...

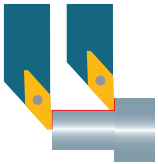

Reinforced version V and version "FC" (fast change)

318

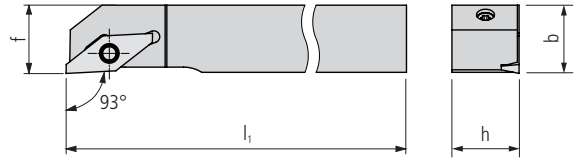

SVJP... V FC* (93°)

Order designation		Dimensions								Inserts	
L	R	h	b	l ₁		f				□ 307...	
STANDARD-LINE											
SVJPL 1212 H10 V FC	■	SVJPR 1212 H10 V FC	■	12	12	100		12			VP..1003..
SVJPL 1616 K10 V FC	■	SVJPR 1616 K10 V FC	■	16	16	125		16			VP..1003..

SVJP... V FC* (93°) INCH

Order designation		Dimensions								Inserts	
L	R	h	b	l ₁		f				□ 307...	
STANDARD-LINE											
SVJPL 1/2" H10 V FC	■	SVJPR 1/2" H10 V FC	■	12.7	12.7	100		12.7			VP..1003..
SVJPL 5/8" K10 V FC	■	SVJPR 5/8" K10 V FC	■	15.875	15.875	125		15.875			VP..1003..

Spare parts (clamping bolts/screws) □ 331

* Note

With this holder, the indexable insert is secured with a screw using a knee lever that can be operated from behind. This means the holder does not have to be unclamped to change the cutting edge.
 Tighten the clamping screw to 1.2 Nm using a torque screwdriver.

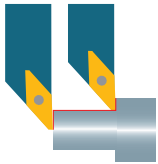

Reinforced version V and version "FC" (fast change) with internal cooling

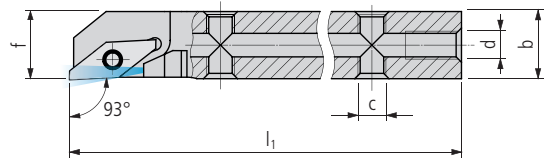
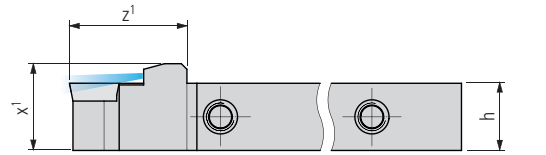

SVJP... V FC* IC (93°)

Order designation		Dimensions										Inserts
L	R	h	b	l ₁	z ¹	x ¹	c	d	f	□ 307...		

PREMIUM-LINE

SVJPL 1212 H10 V FC IC	■	SVJPR 1212 H10 V FC IC	■	12	12	100	21	15.5	M5	M5	12	VP..1003..
SVJPL 1616 K10 V FC IC	■	SVJPR 1616 K10 V FC IC	■	16	16	125	21	19.5	M5	G½"	16	VP..1003..

SVJP... V FC* IC (93°) INCH

Order designation		Dimensions										Inserts
L	R	h	b	l ₁	z ¹	x ¹	c	d	f	□ 307...		

PREMIUM-LINE

SVJPL 1/2" H10 V FC IC	■	SVJPR 1/2" H10 V FC IC	■	12.7	12.7	100	21	15.5	M5	M5	12.7	VP..1003..
SVJPL 5/8" K10 V FC IC	■	SVJPR 5/8" K10 V FC IC	■	15.875	15.875	125	21	19.5	M5	G½"	15.875	VP..1003..

Spare parts (clamping bolts/screws) □ 331

* Note

With this holder, the indexable insert is secured with a screw using a knee lever that can be operated from behind. This means the holder does not have to be unclamped to change the cutting edge.
 Tighten the clamping screw to 1.2 Nm using a torque screwdriver.

Scope of delivery: Holder without coolant connector

Coolant system □ 619...

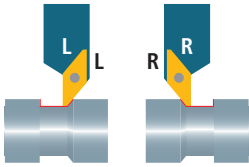

320

UTILIS **multidec**® swiss type tools

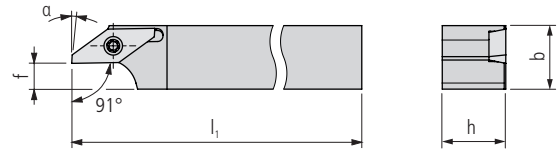
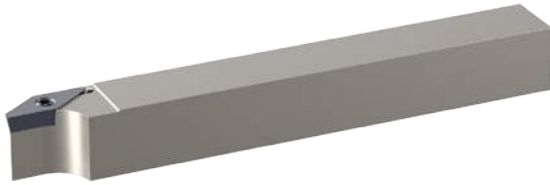

SVXP... (91°)

Order designation		Dimensions							Inserts
L	R	h	b	l ₁	f	a		□ 307...	

STANDARD-LINE

SVXPL 0808 F10	■	SVXPR 0808 F10	■	8	8	80	1	3°	VP..1003..
SVXPL 0808 H10	■	SVXPR 0808 H10	■	8	8	100	1	3°	VP..1003..
SVXPL 1010 F10	■	SVXPR 1010 F10	■	10	10	80	3	3°	VP..1003..
SVXPL 1010 H10	■	SVXPR 1010 H10	■	10	10	100	3	3°	VP..1003..
SVXPL 1212 H10	■	SVXPR 1212 H10	■	12	12	100	5	3°	VP..1003..
SVXPL 1616 K10	■	SVXPR 1616 K10	■	16	16	125	9	3°	VP..1003..
SVXPL 2020 K10	■	SVXPR 2020 K10	■	20	20	125	13	3°	VP..1003..

SVXP... (91°) INCH

Order designation		Dimensions							Inserts
L	R	h	b	l ₁	f	a		□ 307...	

STANDARD-LINE

SVXPL 3/8" F10	■	SVXPR 3/8" F10	■	9.525	9.525	80	2.5	3°	VP..1003..
SVXPL 3/8" H10	■	SVXPR 3/8" H10	■	9.525	9.525	100	2.5	3°	VP..1003..
SVXPL 1/2" H10	■	SVXPR 1/2" H10	■	12.7	12.7	100	5.7	3°	VP..1003..
SVXPL 5/8" K10	■	SVXPR 5/8" K10	■	15.875	15.875	125	8.8	3°	VP..1003..
SVXPL 3/4" K10	■	SVXPR 3/4" K10	■	19.05	19.05	125	12	3°	VP..1003..

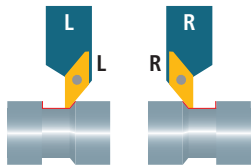

With internal cooling

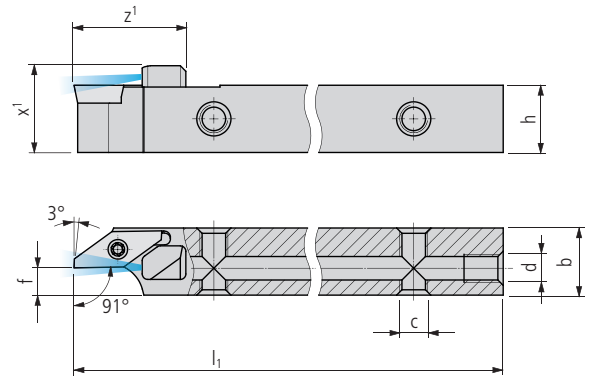

SVXP... IC (91°)

Order designation		Dimensions										Inserts
L	R	h	b	l ₁	z ¹	x ¹	c	d	f	□ 307...		

PREMIUM-LINE

SVXPL 0808 H10 IC	■	SVXPR 0808 H10 IC	■	8	8	100	20	11.5	M5	M5	1	VP..1003..
SVXPL 1010 H10 IC	■	SVXPR 1010 H10 IC	■	10	10	100	20	13.5	M5	M5	3	VP..1003..
SVXPL 1212 H10 IC	■	SVXPR 1212 H10 IC	■	12	12	100	20	15.5	M5	M5	5	VP..1003..
SVXPL 1616 K10 IC	■	SVXPR 1616 K10 IC	■	16	16	125	20	19.5	M5	G½"	9	VP..1003..
SVXPL 2020 K10 IC	■	SVXPR 2020 K10 IC	■	20	20	125	20	23.5	M5	G½"	13	VP..1003..

SVXP... IC (91°) INCH

Order designation		Dimensions										Inserts
L	R	h	b	l ₁	z ¹	x ¹	c	d	f	□ 307...		

PREMIUM-LINE

SVXPL 3/8" H10 IC	■	SVXPR 3/8" H10 IC	■	9.525	9.525	100	20	13	M5	M5	2.5	VP..1003..
SVXPL 1/2" H10 IC	■	SVXPR 1/2" H10 IC	■	12.7	12.7	100	20	16.2	M5	M5	5.7	VP..1003..
SVXPL 5/8" K10 IC	■	SVXPR 5/8" K10 IC	■	15.875	15.875	125	20	19.4	M5	G½"	8.8	VP..1003..
SVXPL 3/4" K10 IC	■	SVXPR 3/4" K10 IC	■	19.05	19.05	125	20	22.6	M5	G½"	12	VP..1003..

Scope of delivery: Holder without coolant connector

Coolant system □ 619...

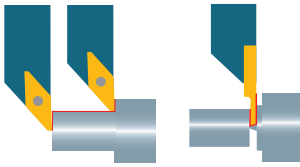

"TWIN" version

322

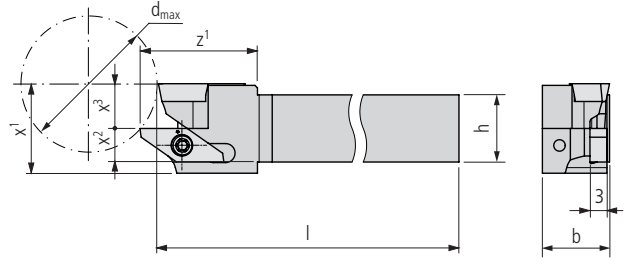

SVJP. (93°)/1600... TWIN (R-R)

Order designation	Dimensions									Inserts	
	h	b	l	z ¹	x ¹	x ²	x ³	d _{max}	□307...	□49...	

STANDARD-LINE

SVJPR/1600R-0810 H10 Twin	■	8	10	100	21	16	4	8	23	VP..1003..	16...
SVJPR/1600R-1010 H10 Twin	■	10	10	100	21	16	5	8	23	VP..1003..	16...
SVJPR/1600R-1212 H10 Twin	■	12	12	100	21	16	6	8	23	VP..1003..	16...
SVJPR/1600R-1616 K10 Twin	■	16	16	125	21	20	8	10	34	VP..1003..	16...
SVJPR/1600R-2020 K10 Twin	■	20	20	125	21	24	8	14	63	VP..1003..	16...

SVJP. (93°)/1600... TWIN INCH (R-R)

Order designation	Dimensions									Inserts	
	h	b	l	z ¹	x ¹	x ²	x ³	d _{max}	□307...	□49...	

STANDARD-LINE

SVJPR/1600R-3/8" H10 Twin	■	9.525	9.525	100	21	16	4.76	8	23	VP..1003..	16...
SVJPR/1600R-1/2" H10 Twin	■	12.7	12.7	100	21	16	6.35	8	23	VP..1003..	16...
SVJPR/1600R-5/8" K10 Twin	■	15.875	15.875	125	21	20	7.94	10	34	VP..1003..	16...
SVJPR/1600R-3/4" K10 Twin	■	19.05	19.05	125	21	24	7.53	14	63	VP..1003..	16...

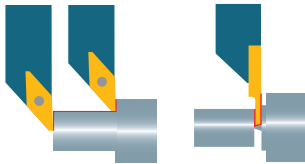

"TWIN" version with internal cooling

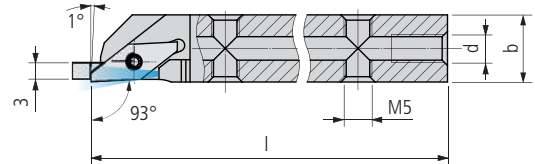
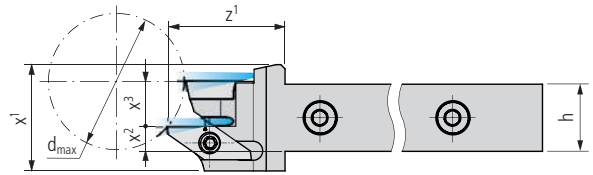

SVJP. (93°)/1600... TWIN IC (R-R)

Order designation	Dimensions										Inserts	
	h	b	l	z ¹	x ¹	x ²	x ³	d	d _{max}	□ 307...	□ 49...	

PREMIUM-LINE

	SVJPR/1600R-0810 H10 Twin IC	■	8	10	100	21	19	2.5	8	M5	23	VP..1003..	16...
	SVJPR/1600R-1010 H10 Twin IC	■	10	10	100	21	19	3.5	8	M5	23	VP..1003..	16...
	SVJPR/1600R-1212 H10 Twin IC	■	12	12	100	21	19	4.5	8	M5	23	VP..1003..	16...
	SVJPR/1600R-1616 K10 Twin IC	■	16	16	125	21	23	6.5	10	G ¹ / ₈ "	34	VP..1003..	16...
	SVJPR/1600R-2020 K10 Twin IC	■	20	20	125	21	27	6.5	14	G ¹ / ₈ "	63	VP..1003..	16...

SVJP. (93°)/1600... TWIN IC INCH (R-R)

Order designation	Dimensions										Inserts	
	h	b	l	z ¹	x ¹	x ²	x ³	d	d _{max}	□ 307...	□ 49...	

PREMIUM-LINE

	SVJPR/1600R-3/8" H10 Twin IC	■	9.525	9.525	100	21	19	3.26	8	M5	23	VP..1003..	16...
	SVJPR/1600R-1/2" H10 Twin IC	■	12.7	12.7	100	21	19	4.85	8	M5	23	VP..1003..	16...
	SVJPR/1600R-5/8" K10 Twin IC	■	15.875	15.875	125	21	23	6.44	10	G ¹ / ₈ "	34	VP..1003..	16...
	SVJPR/1600R-3/4" K10 Twin IC	■	19.05	19.05	125	21	27	6.03	14	G ¹ / ₈ "	63	VP..1003..	16...

Scope of delivery: Holder without coolant connector

Coolant system □ 619...

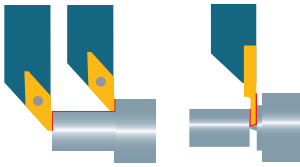

"TWIN" version

324

UTILIS **multidec**® swiss type tools

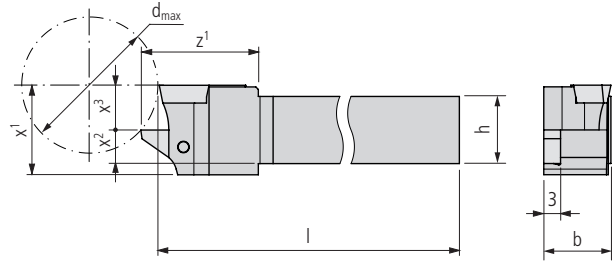

SVJP. (93°)/1600... TWIN (R-L)

Order designation	Dimensions									Inserts	
	h	b	l	z¹	x¹	x²	x³	d _{max}	□307...	□49...	
<div style="display: flex; align-items: center;"> <div style="margin-right: 10px;"> <div style="border: 1px solid black; padding: 2px; width: 15px; height: 15px; margin-bottom: 2px;">R</div> <div style="border: 1px solid black; padding: 2px; width: 15px; height: 15px;">L</div> </div> </div>											
STANDARD-LINE											
SVJPR/1600L-0810 H10 Twin	■	8	10	100	21	16	4	8	23	VP..1003..	16...
SVJPR/1600L-1010 H10 Twin	■	10	10	100	21	16	5	8	23	VP..1003..	16...
SVJPR/1600L-1212 H10 Twin	■	12	12	100	21	16	6	8	23	VP..1003..	16...
SVJPR/1600L-1616 K10 Twin	■	16	16	125	21	20	8	10	33	VP..1003..	16...
SVJPR/1600L-2020 K10 Twin	■	20	20	125	21	24	8	12	63	VP..1003..	16...

SVJP. (93°)/1600... TWIN INCH (R-L)

Order designation	Dimensions									Inserts	
	h	b	l	z¹	x¹	x²	x³	d _{max}	□307...	□49...	
<div style="display: flex; align-items: center;"> <div style="margin-right: 10px;"> <div style="border: 1px solid black; padding: 2px; width: 15px; height: 15px; margin-bottom: 2px;">R</div> <div style="border: 1px solid black; padding: 2px; width: 15px; height: 15px;">L</div> </div> </div>											
STANDARD-LINE											
SVJPR/1600L-3/8" H10 Twin	■	9.525	9.525	100	21	16	4.76	8	23	VP..1003..	16...
SVJPR/1600L-1/2" H10 Twin	■	12.7	12.7	100	21	16	6.35	8	23	VP..1003..	16...
SVJPR/1600L-5/8" K10 Twin	■	15.875	15.875	125	21	20	7.94	10	33	VP..1003..	16...
SVJPR/1600L-3/4" K10 Twin	■	19.05	19.05	125	21	24	7.53	14	63	VP..1003..	16...

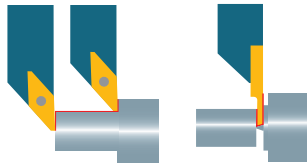

"TWIN" version with internal cooling

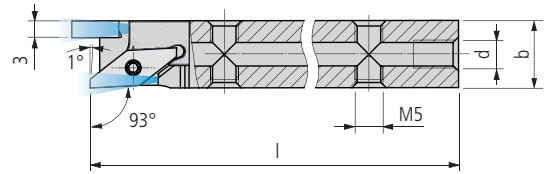
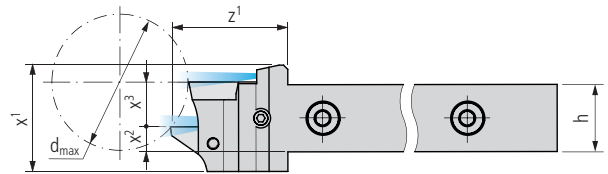

SVJP. (93°)/1600... TWIN IC (R-L)

Order designation	Dimensions										Inserts	
	h	b	l	z ¹	x ¹	x ²	x ³	d	d _{max}	□ 307...	□ 49...	



PREMIUM-LINE

	SVJPR/1600L-0810 H10 Twin IC	■	8	10	100	21	19	2.5	8	M5	23	VP..1003..	16...
	SVJPR/1600L-1010 H10 Twin IC	■	10	10	100	21	19	3.5	8	M5	23	VP..1003..	16...
	SVJPR/1600L-1212 H10 Twin IC	■	12	12	100	21	19	4.5	8	M5	23	VP..1003..	16...
	SVJPR/1600L-1616 K10 Twin IC	■	16	16	125	21	23	6.5	10	G1/8"	33	VP..1003..	16...
	SVJPR/1600L-2020 K10 Twin IC	■	20	20	125	21	27	6.5	14	G1/8"	63	VP..1003..	16...

SVJP. (93°)/1600... TWIN IC INCH (R-L)

Order designation	Dimensions										Inserts	
	h	b	l	z ¹	x ¹	x ²	x ³	d	d _{max}	□ 307...	□ 49...	



PREMIUM-LINE

	SVJPR/1600L-3/8" H10 Twin IC	■	9.525	9.525	100	21	19	3.26	8	M5	23	VP..1003..	16...
	SVJPR/1600L-1/2" H10 Twin IC	■	12.7	12.7	100	21	19	4.85	8	M5	23	VP..1003..	16...
	SVJPR/1600L-5/8" K10 Twin IC	■	15.875	15.875	125	21	23	6.44	10	G1/8"	33	VP..1003..	16...
	SVJPR/1600L-3/4" K10 Twin IC	■	19.05	19.05	125	21	27	6.03	14	G1/8"	63	VP..1003..	16...

Scope of delivery: Holder without coolant connector

Coolant system □ 619...

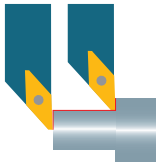

"Y-AXIS" version with internal cooling

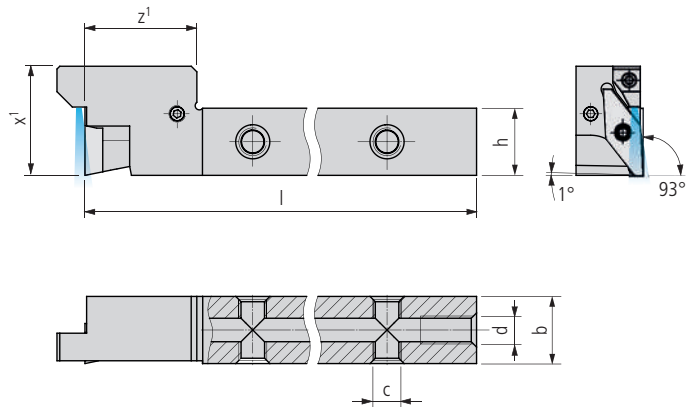

326



SVJP.YA... IC (93°)

Order designation		Dimensions									Inserts
L	R	h	b	l ₁	z ¹	x ¹	c	d		□ 307...	

PREMIUM-LINE

		SVJPR YA-1212 H10-20 IC	■	12	12	100	20	19.5	M5	M5	VP.. 1003...
		SVJPR YA-1212 H10-25 IC	■	12	12	100	25	19.5	M5	M5	VP.. 1003...
		SVJPR YA-1212 H10-30 IC	■	12	12	100	30	19.5	M5	M5	VP.. 1003...
		SVJPR YA-1616 K10-20 IC	■	16	16	125	20	19.5	M5	G ¹ / ₈	VP.. 1003...
		SVJPR YA-1616 K10-25 IC	■	16	16	125	25	19.5	M5	G ¹ / ₈	VP.. 1003...
		SVJPR YA-1616 K10-30 IC	■	16	16	125	30	19.5	M5	G ¹ / ₈	VP.. 1003...

SVJP.YA... IC (93°) INCH

Order designation		Dimensions									Inserts
L	R	h	b	l ₁	z ¹	x ¹	c	d		□ 307...	

PREMIUM-LINE

		SVJPR YA-1/2" H10-20 IC	■	12.7	12.7	100	20	19.5	M5	M5	VP.. 1003...
		SVJPR YA-1/2" H10-25 IC	■	12.7	12.7	100	25	19.5	M5	M5	VP.. 1003...
		SVJPR YA-1/2" H10-30 IC	■	12.7	12.7	100	30	19.5	M5	M5	VP.. 1003...
		SVJPR YA-5/8" K10-20 IC	■	15.875	15.875	125	20	19.5	M5	G ¹ / ₈	VP.. 1003...
		SVJPR YA-5/8" K10-25 IC	■	15.875	15.875	125	25	19.5	M5	G ¹ / ₈	VP.. 1003...
		SVJPR YA-5/8" K10-30 IC	■	15.875	15.875	125	30	19.5	M5	G ¹ / ₈	VP.. 1003...

Usage notes:

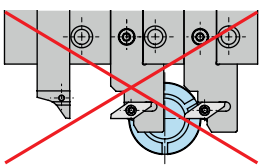

To avoid problems, two Y-AXIS holders must not be mounted directly next to each other. Mount a standard tool holder between the Y-AXIS holders.

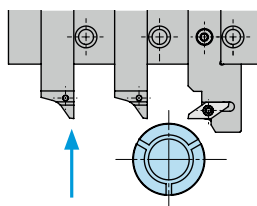

To prevent collisions, move back the holder in accordance with the overhanging length before changing the tool position.

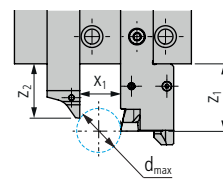

$$d_{\max} = \frac{(z_1 - z_2)^2 + x_1^2}{x_1}$$

Scope of delivery: Holder without coolant connector
 Coolant system □ 619...

Legend □ 8...

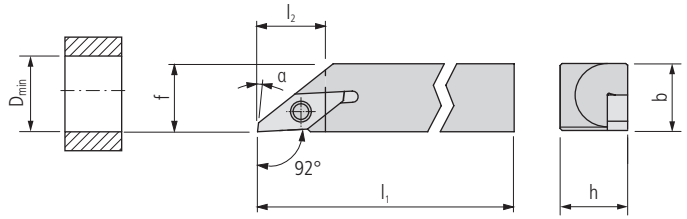

SVJP... (92°)

Order designation		Dimensions									Inserts
L	R	h	b	l ₁	l ₂	f	D _{min}	a		□ 307...	
STANDARD-LINE											
SVJPL 1212 XH10	■	SVJPR 1212 XH10	■	12	12	100	12	12.2	16	2°	VP..1003..
SVJPL 1616 XK10	■	SVJPR 1616 XK10	■	16	16	125	12	16.2	16	2°	VP..1003..

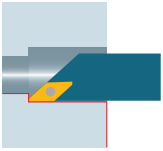

328

UTILIS **multidec**®
swiss type tools

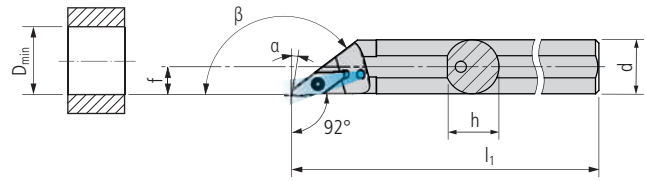

A... SVJP... (92°)

Order designation		Dimensions								Inserts	
L	R	d	h	l ₁	f	D _{min}	α	β	□ 307...		
STANDARD-LINE											
A16M SVJPL 10	■	A16M SVJPR 10	■	16	15.3	150	8.3	20	2°	143°	VP..1003..

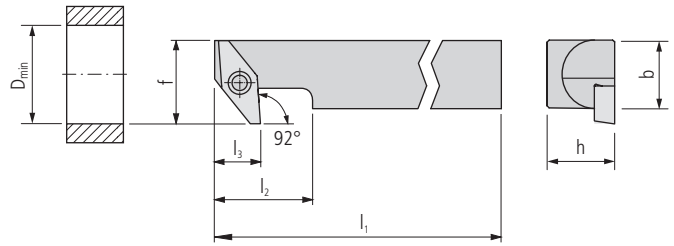
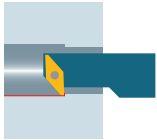

SVQP... (92°)

Order designation		Dimensions									Inserts	
L	R	h	b	l ₁	l ₂	f	D _{min}	l ₃			□ 307...	
STANDARD-LINE												
SVQPL 1212 XH10	■	SVQPR 1212 XH10	■	12	12	100	12	15.7	16	7.7		VP..1003..
SVQPL 1616 XK10	■	SVQPR 1616 XK10	■	16	16	125	12	15.7	16	7.7		VP..1003..

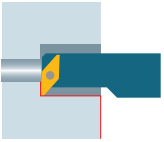

330

UTILIS **multidec**® swiss type tools

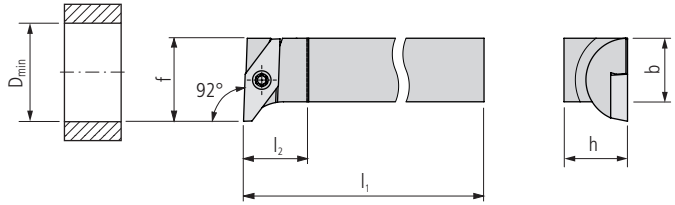

SVUP... (92°)

Order designation		Dimensions							Inserts
L	R	h	b	l ₁	l ₂	f	D _{min}	□ 307...	

STANDARD-LINE



SVUPL 1212 XH10	■	SVUPR 1212 XH10	■	12	12	100	12	15.7	17		VP..1003..
SVUPL 1616 XK10	■	SVUPR 1616 XK10	■	16	16	125	12	15.7	17		VP..1003..

* Attention
 Right hand holder needs left hand insert!

For holders (SV.P...) OD turning

Illustration	Description	Dimensions	Order designation		Holder
	TORX screw	M2.5 × 6 T08	MSP 25060 T08	■	SV.P... 10

For holders (SV.P... FC) OD turning

Illustration	Description	Dimensions	Order designation		Holder
	Clamping bolts	3 × 10	MSP SB 35080 FC	■	SV.P... 10 FC
	Clamping screw	M3 × 10	MSP KS 30080 FC T06	■	SV.P... 10 FC

For holders (... SV.P...) ID turning

Illustration	Description	Dimensions	Order designation		Holder
	TORX screw	M2.5 × 6 T08	MSP 25060 T08	■	A... SV.P... 10

TORX screwdriver 651...

	Steel unalloyed			Steel low alloyed			Steel high alloyed		
Hardness value (HB)/(HRC)	125–300 HB			180–250 HB			200–350 HB		
Category	I			II			III		
Machining method	▼	▼▼	▼▼▼	▼	▼▼	▼▼▼	▼	▼▼	▼▼▼
Cutting speeds	v _c (m/min)								
Cutting material carbide									
UHM 10	40–110	60–120	60–140	60–100	60–120	60–130	40–90	60–110	60–120
UHM 10 HX	60–180	60–220	60–260	60–170	60–200	60–240	50–160	60–180	60–220
UHM 10 TX+	–	–	–	80–150	100–180	160–220	70–100	90–150	120–180
UHM 10 MZ	180–300	220–400	250–500	150–280	200–320	250–400	120–280	180–320	180–320
UHM 20 HPX	150–200	180–220	200–260	80–150	100–180	160–220	70–100	90–150	120–180
UHM 20 TX+	–	–	–	80–130	100–150	160–190	70–90	90–130	120–150
UHM 20 MZ	130–180	160–220	180–260	100–160	110–180	130–220	70–150	110–160	130–190
UHM 30	30–70	50–80	50–100	30–60	40–80	40–90	30–50	30–70	30–80
UHM 30 HX	50–140	50–180	50–220	50–130	50–160	50–200	40–120	50–140	50–180
UHM 30 TX+	50–120	50–140	50–150	50–100	50–120	50–140	40–80	50–100	50–110
UHM 30 MZ	120–160	150–200	170–240	90–140	100–160	120–200	60–130	90–140	110–160
UHM 30 SX	50–120	50–180	50–200	50–100	50–140	50–180	40–90	50–120	50–160

	Stainless steel			Stainless steel			Titanium		
Hardness value (HB)/(HRC)	180–220 HB			220–330 HB			–		
Category	V			VI			IV		
Machining method	▼	▼▼	▼▼▼	▼	▼▼	▼▼▼	▼	▼▼	▼▼▼
Cutting speeds	v _c (m/min)								
Cutting material carbide									
UHM 10	40–100	40–110	40–120	30–70	30–80	30–80	40–60	50–70	60–80
UHM 10 HX	50–140	50–180	50–220	40–100	50–110	50–130	40–120	50–130	50–150
UHM 10 TX+	90–150	110–180	160–200	70–90	90–120	110–150	50–100	60–120	60–140
UHM 10 MZ	100–180	180–250	220–300	–	–	–	–	–	–
UHM 20 HPX	90–150	110–180	160–200	70–90	90–120	110–150	50–100	60–120	60–140
UHM 20 TX+	90–130	110–160	160–180	70–90	90–120	110–150	50–100	60–120	60–140
UHM 20 MZ	90–150	110–160	130–180	50–80	30–50	40–70	–	–	–
UHM 30	30–60	30–70	30–80	20–30	20–40	20–40	40–50	25–60	30–70
UHM 30 HX	40–100	40–140	40–180	30–60	40–70	40–90	30–90	40–100	40–120
UHM 30 TX+	–	–	–	–	–	–	–	–	–
UHM 30 MZ	80–130	100–140	110–160	40–80	50–90	90–110	–	–	–
UHM 30 SX	30–90	40–120	40–160	20–50	30–60	30–80	–	–	–

	Aluminum			Brass			Hard materials		
Hardness value (HB)/(HRC)	60–130 HB			–			45–70 HRC		
Category	VII			VIII			X		
Machining method	▼	▼▼	▼▼▼	▼	▼▼	▼▼▼	▼	▼▼	▼▼▼
Cutting speeds	v_c (m/min)								
Cutting material carbide									
UHM 10	100–1500	120–2000	160–2500	80–300	100–400	120–500	–	–	–
UHM 10 HX	140–2500	160–3000	200–3000	100–450	100–600	100–750	–	–	–
UHM 10 TX+	–	–	–	–	–	–	15–30	15–40	20–80
UHM 10 MZ	–	–	–	–	–	–	–	–	–
UHM 20 HPX	–	–	–	–	–	–	–	–	–
UHM 20 TX+	–	–	–	–	–	–	–	–	–
UHM 20 MZ	–	–	–	–	–	–	–	–	–
UHM 30	50–1000	60–1200	80–1500	40–100	50–140	50–160	–	–	–
UHM 30 HX	70–1500	80–2000	100–3000	50–150	50–200	50–250	–	–	–
UHM 30 TX+	–	–	–	–	–	–	–	–	–
UHM 30 MZ	–	–	–	–	–	–	–	–	–
UHM 30 SX	60–1200	80–2000	100–3000	50–120	50–180	50–200	–	–	–

Feed (f) and depths of cut (a_p) 307...

multidec®-BORE MICRO provides a wide range of inserts for miniaturized ID-turning (diameter between 0.5 and 8 mm). Sharp edges, small radii and ground surfaces guarantee accurate cutting. multidec-BORE MICRO is excellent for machining of common materials as well as exotic alloys. multidec®-BORE MICRO carbide tools are available with wear-resistant coatings as well as uncoated. The heat-treated tool-holder SDA ... can be fixed in a usual chuck or ID tool station. The inserts can be replaced by hand without any measuring or adjusting of axial and radial position. The unique clamping nut ensures accurate location of the boring tool and prevents vibration.

334

UTILIS
multidec®
swiss type tools

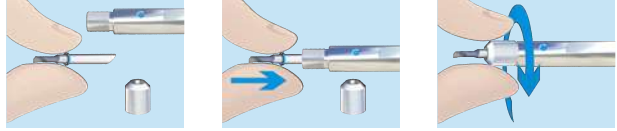

Advantages:

- For internal machining methods with small diameters:
 - high positioning accuracy
 - internal cooling system and
 - smallest internal diameter of 0.5 mm
- Sharp cutting edges
- Different coatings are available
 - tenacious carbide grade
 - coated and uncoated

The Superclamp holder offers higher holding forces and better stability, needed especially for broaching, hard cutting with CBN and machining of finest surfaces with PCD, CVD-Diamond and MCD, in non-ferrous materials.



AKR-Mono is a holder for use on the outside turning position when no more inside holder fixing space is available.



Overview – multidec®-BORE MICRO

Technical information		11																								
Application ID turning		336																								
Inserts		338																								
Holders		360																								
Holder Superclamp		362																								
Holder AKR-Mono		363																								
Replacement and spare parts		364																								
Cutting specification	<table border="1"> <thead> <tr> <th></th> <th>Spindel-Längenbereich Spindel-Länge Spindel-Länge</th> <th>Spindel-Längenbereich Spindel-Länge Spindel-Länge</th> <th>Spindel-Längenbereich Spindel-Länge Spindel-Länge</th> <th>Spindel-Längenbereich Spindel-Länge Spindel-Länge</th> <th>Spindel-Längenbereich Spindel-Länge Spindel-Länge</th> </tr> </thead> <tbody> <tr> <td>Spindel-Länge</td> <td>115-200</td> <td>160-250</td> <td>200-300</td> <td></td> <td></td> </tr> <tr> <td>Spindel-Länge</td> <td>I</td> <td>II</td> <td>III</td> <td>IV</td> <td>V</td> </tr> <tr> <td>Spindel-Länge</td> <td>▼ ▼ ▼ ▼ ▼</td> <td>▼ ▼ ▼ ▼ ▼</td> <td>▼ ▼ ▼ ▼ ▼</td> <td>▼ ▼ ▼ ▼ ▼</td> <td>▼ ▼ ▼ ▼ ▼</td> </tr> </tbody> </table>		Spindel-Längenbereich Spindel-Länge Spindel-Länge	Spindel-Längenbereich Spindel-Länge Spindel-Länge	Spindel-Längenbereich Spindel-Länge Spindel-Länge	Spindel-Längenbereich Spindel-Länge Spindel-Länge	Spindel-Längenbereich Spindel-Länge Spindel-Länge	Spindel-Länge	115-200	160-250	200-300			Spindel-Länge	I	II	III	IV	V	Spindel-Länge	▼ ▼ ▼ ▼ ▼	▼ ▼ ▼ ▼ ▼	▼ ▼ ▼ ▼ ▼	▼ ▼ ▼ ▼ ▼	▼ ▼ ▼ ▼ ▼	366
	Spindel-Längenbereich Spindel-Länge Spindel-Länge	Spindel-Längenbereich Spindel-Länge Spindel-Länge	Spindel-Längenbereich Spindel-Länge Spindel-Länge	Spindel-Längenbereich Spindel-Länge Spindel-Länge	Spindel-Längenbereich Spindel-Länge Spindel-Länge																					
Spindel-Länge	115-200	160-250	200-300																							
Spindel-Länge	I	II	III	IV	V																					
Spindel-Länge	▼ ▼ ▼ ▼ ▼	▼ ▼ ▼ ▼ ▼	▼ ▼ ▼ ▼ ▼	▼ ▼ ▼ ▼ ▼	▼ ▼ ▼ ▼ ▼																					
Special tools – multidec4you®		600																								
Accessories		651																								

Drilling and Turning

Inserts □ 339...

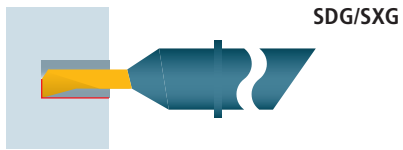

Front turning

Inserts □ 345...

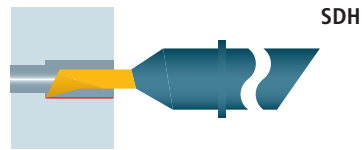

Turning and facing

Inserts □ 341...

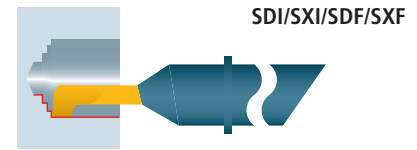

Turning and front turning

Inserts □ 346...

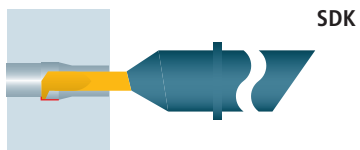

Back turning

Inserts □ 347...

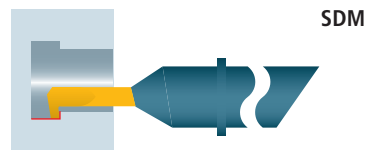

Turning

Inserts □ 348...

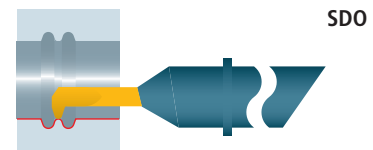

Turning

Inserts □ 349...

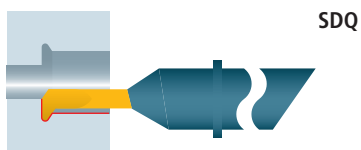

Longitudinal turning and chamfering

Inserts □ 350...

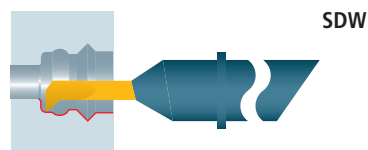

Radius-grooving

Inserts □ 351...

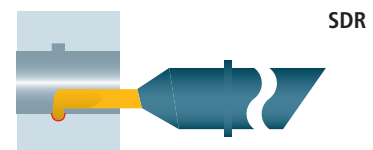

Grooving

Inserts □ 352...

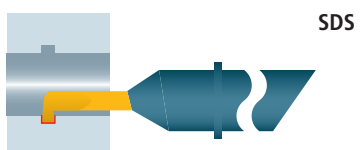

Grooving and Turning

Inserts □ 353...

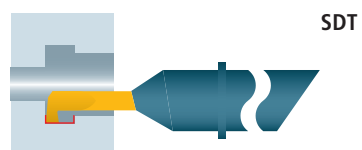

Threading (partial profile)

Inserts □ 354...

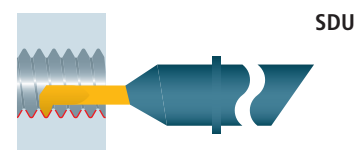

Threading (full profile)

Inserts □ 355...

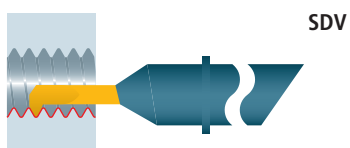

Chamfering

Inserts [356...](#)

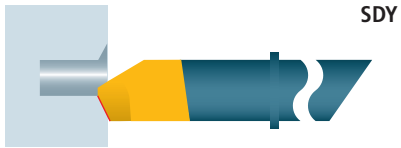

Radius

Inserts [357...](#)



Copy turning (axial)

Inserts [358...](#)

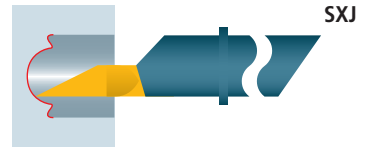

Grooving (axial)

Inserts [359...](#)

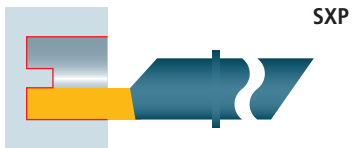

Holders [360...](#)

All illustrations show right hand design. Left hand design is also available.



Blank

338

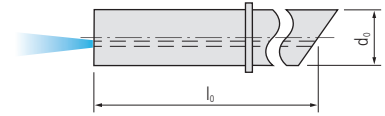

SD ...

Order designation	Carbide □ 20	Dimensions										Holder		
R	○	d ₀	l ₀										□ 360...	
	○													
	○													
	●													
	-													
	UHM 20													

PREMIUM-LINE

SD 448 R ...	■	4	48										SDA 4...
SD 668 R ...	■	6	68										SDA 6...
SD 882 R ...	■	8	82										SDA 8...

UTILIS
multidec[®]
swiss type tools

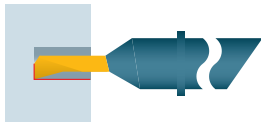

Drilling and turning

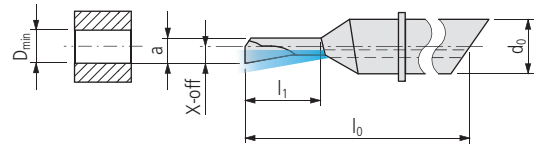
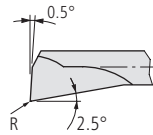

SDG ...

Order designation	Carbide			Dimensions										Holder	
	<input type="checkbox"/> 20	<input type="checkbox"/> 20	<input type="checkbox"/> 20	D _{min}	l ₁	d ₀	a	X-off	l ₀	R					360...
R *	<input type="checkbox"/>	<input type="checkbox"/>	<input type="checkbox"/>												
	<input type="checkbox"/>	<input type="checkbox"/>	<input type="checkbox"/>												
	<input type="checkbox"/>	<input type="checkbox"/>	<input type="checkbox"/>												
	<input type="checkbox"/>	<input type="checkbox"/>	<input type="checkbox"/>												
	<input type="checkbox"/>	<input type="checkbox"/>	<input type="checkbox"/>												
	<input type="checkbox"/>	<input type="checkbox"/>	<input type="checkbox"/>												
	<input type="checkbox"/>	<input type="checkbox"/>	<input type="checkbox"/>												
	<input type="checkbox"/>	<input type="checkbox"/>	<input type="checkbox"/>												
	<input type="checkbox"/>	<input type="checkbox"/>	<input type="checkbox"/>												
	<input type="checkbox"/>	<input type="checkbox"/>	<input type="checkbox"/>												
	<input type="checkbox"/>	<input type="checkbox"/>	<input type="checkbox"/>												
	<input type="checkbox"/>	<input type="checkbox"/>	<input type="checkbox"/>												
	<input type="checkbox"/>	<input type="checkbox"/>	<input type="checkbox"/>												
	<input type="checkbox"/>	<input type="checkbox"/>	<input type="checkbox"/>												
	<input type="checkbox"/>	<input type="checkbox"/>	<input type="checkbox"/>												
	<input type="checkbox"/>	<input type="checkbox"/>	<input type="checkbox"/>												
	<input type="checkbox"/>	<input type="checkbox"/>	<input type="checkbox"/>												
	<input type="checkbox"/>	<input type="checkbox"/>	<input type="checkbox"/>												
	<input type="checkbox"/>	<input type="checkbox"/>	<input type="checkbox"/>												
	<input type="checkbox"/>	<input type="checkbox"/>	<input type="checkbox"/>												
	<input type="checkbox"/>	<input type="checkbox"/>	<input type="checkbox"/>												
	<input type="checkbox"/>	<input type="checkbox"/>	<input type="checkbox"/>												
	<input type="checkbox"/>	<input type="checkbox"/>	<input type="checkbox"/>												
	<input type="checkbox"/>	<input type="checkbox"/>	<input type="checkbox"/>												
	<input type="checkbox"/>	<input type="checkbox"/>	<input type="checkbox"/>												
	<input type="checkbox"/>	<input type="checkbox"/>	<input type="checkbox"/>												
	<input type="checkbox"/>	<input type="checkbox"/>	<input type="checkbox"/>												
	<input type="checkbox"/>	<input type="checkbox"/>	<input type="checkbox"/>												
	<input type="checkbox"/>	<input type="checkbox"/>	<input type="checkbox"/>												
	<input type="checkbox"/>	<input type="checkbox"/>	<input type="checkbox"/>												
	<input type="checkbox"/>	<input type="checkbox"/>	<input type="checkbox"/>												
	<input type="checkbox"/>	<input type="checkbox"/>	<input type="checkbox"/>												
	<input type="checkbox"/>	<input type="checkbox"/>	<input type="checkbox"/>												
	<input type="checkbox"/>	<input type="checkbox"/>	<input type="checkbox"/>												
	<input type="checkbox"/>	<input type="checkbox"/>	<input type="checkbox"/>												
	<input type="checkbox"/>	<input type="checkbox"/>	<input type="checkbox"/>												
	<input type="checkbox"/>	<input type="checkbox"/>	<input type="checkbox"/>												
	<input type="checkbox"/>	<input type="checkbox"/>	<input type="checkbox"/>												
	<input type="checkbox"/>	<input type="checkbox"/>	<input type="checkbox"/>												
	<input type="checkbox"/>	<input type="checkbox"/>	<input type="checkbox"/>												
	<input type="checkbox"/>	<input type="checkbox"/>	<input type="checkbox"/>												
	<input type="checkbox"/>	<input type="checkbox"/>	<input type="checkbox"/>												
	<input type="checkbox"/>	<input type="checkbox"/>	<input type="checkbox"/>												
	<input type="checkbox"/>	<input type="checkbox"/>	<input type="checkbox"/>												
	<input type="checkbox"/>	<input type="checkbox"/>	<input type="checkbox"/>												
	<input type="checkbox"/>	<input type="checkbox"/>	<input type="checkbox"/>												
	<input type="checkbox"/>	<input type="checkbox"/>	<input type="checkbox"/>												
	<input type="checkbox"/>	<input type="checkbox"/>	<input type="checkbox"/>												
	<input type="checkbox"/>	<input type="checkbox"/>	<input type="checkbox"/>												

PREMIUM-LINE

SDG 435 042 R ...	■	■	□	0.42	1.5	4	0.38	0.21	35	0.02					SDA 4...
SDG 435 052 R ...	■	■	□	0.52	1.8	4	0.47	0.26	35	0.02					SDA 4...
SDG 435 072 R ...	■	■	□	0.72	2.4	4	0.65	0.36	35	0.03					SDA 4...
SDG 435 092 R ...	■	■	□	0.92	3	4	0.83	0.46	35	0.03					SDA 4...
SDG 440 092 R ...	■	■	□	0.92	3	4	0.83	0.46	40	0.03					SDA 4...
SDG 448 092 R ...	■	■	□	0.92	5	4	0.83	0.46	48	0.03					SDA 4...
SDG 435 122 R ...	■	■	□	1.22	3.9	4	1.10	0.61	35	0.03					SDA 4...
SDG 435 142 R ...	■	■	□	1.42	4.5	4	1.28	0.71	35	0.03					SDA 4...
SDG 440 142 R ...	■	■	□	1.42	4.5	4	1.28	0.71	40	0.03					SDA 4...
SDG 448 142 R ...	■	■	□	1.42	7.5	4	1.28	0.71	48	0.03					SDA 4...
SDG 435 192 R ...	■	■	□	1.92	6	4	1.73	0.96	35	0.04					SDA 4...
SDG 440 192 R ...	■	■	□	1.92	6	4	1.73	0.96	40	0.04					SDA 4...
SDG 448 192 R ...	■	■	□	1.92	10	4	1.73	0.96	48	0.04					SDA 4...
SDG 435 242 R ...	■	■	□	2.42	7.5	4	2.18	1.21	35	0.04					SDA 4...
SDG 440 242 R ...	■	■	□	2.42	7.5	4	2.18	1.21	40	0.04					SDA 4...
SDG 448 242 R ...	■	■	□	2.42	12.5	4	2.18	1.21	48	0.04					SDA 4...
SDG 440 292 R ...	■	■	□	2.92	9	4	2.63	1.46	40	0.05					SDA 4...
SDG 448 292 R ...	■	■	□	2.92	15	4	2.63	1.46	48	0.05					SDA 4...
SDG 440 342 R ...	■	■	□	3.42	10.5	4	3.08	1.71	40	0.05					SDA 4...
SDG 448 342 R ...	■	■	□	3.42	17.5	4	3.08	1.71	48	0.05					SDA 4...
SDG 440 392 R ...	■	■	□	3.92	12	4	3.53	1.96	40	0.06					SDA 4...
SDG 448 392 R ...	■	■	□	3.92	20	4	3.53	1.96	48	0.06					SDA 4...
SDG 644 442 R ...	■	■	□	4.42	9	6	3.98	2.21	44	0.06					SDA 6...
SDG 656 442 R ...	■	■	□	4.42	18	6	3.98	2.21	56	0.06					SDA 6...
SDG 668 442 R ...	■	■	□	4.42	27	6	3.98	2.21	68	0.06					SDA 6...
SDG 644 492 R ...	■	■	□	4.92	10	6	4.43	2.46	44	0.07					SDA 6...
SDG 656 492 R ...	■	■	□	4.92	20	6	4.43	2.46	56	0.07					SDA 6...
SDG 668 492 R ...	■	■	□	4.92	30	6	4.43	2.46	68	0.07					SDA 6...
SDG 644 542 R ...	■	■	□	5.42	11	6	4.88	2.71	44	0.07					SDA 6...
SDG 656 542 R ...	■	■	□	5.42	22	6	4.88	2.71	56	0.07					SDA 6...
SDG 668 542 R ...	■	■	□	5.42	33	6	4.88	2.71	68	0.07					SDA 6...
SDG 644 592 R ...	■	■	□	5.92	12	6	5.33	2.96	44	0.08					SDA 6...
SDG 656 592 R ...	■	■	□	5.92	24	6	5.33	2.96	56	0.08					SDA 6...
SDG 668 592 R ...	■	■	□	5.92	36	6	5.33	2.96	68	0.08					SDA 6...
SDG 850 692 R ...	■	■	□	6.92	14	8	6.23	3.46	50	0.09					SDA 8...
SDG 866 692 R ...	■	■	□	6.92	28	8	6.23	3.46	66	0.09					SDA 8...
SDG 882 692 R ...	■	■	□	6.92	42	8	6.23	3.46	82	0.09					SDA 8...
SDG 850 792 R ...	■	■	□	7.92	16	8	7.13	3.96	50	0.1					SDA 8...
SDG 866 792 R ...	■	■	□	7.92	32	8	7.13	3.96	66	0.1					SDA 8...
SDG 882 792 R ...	■	■	□	7.92	48	8	7.13	3.96	82	0.1					SDA 8...

* Left execution and other coatings on demand

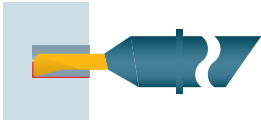

Drilling and turning
Strengthen type (for blind holes)

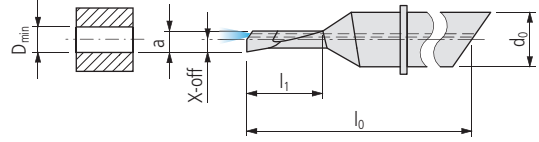
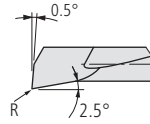

SXG ...

Order designation	Carbide	□ 20	Dimensions								Holder
	○ ● ●	● ● ●	D _{min}	l ₁	d ₀	a	X-off	l ₀	R		□ 360...
	○ ○ ○	● ● ●									
	● ● ●	○ ○ ○									
	-	-									
		○									
R	UHM 20	UHM 20HX									
*	UHM 20TX+										

UTILIS **multidec**®
swiss type tools

PREMIUM-LINE

SXG 435 042 R ...	■	■	□	0.42	1.5	4	0.38	0.21	35	0.02										SDA 4...	
SXG 435 052 R ...	■	■	□	0.52	2	4	0.47	0.26	35	0.02											SDA 4...
SXG 435 072 R ...	■	■	□	0.72	2.5	4	0.65	0.36	35	0.02											SDA 4...
SXG 435 092 R ...	■	■	□	0.92	3	4	0.83	0.46	35	0.02											SDA 4...
SXG 440 092 R ...	■	■	□	0.92	5	4	0.83	0.46	40	0.02											SDA 4...
SXG 435 122 R ...	■	■	□	1.22	4	4	1.1	0.61	35	0.02											SDA 4...
SXG 435 142 R ...	■	■	□	1.42	4.5	4	1.28	0.71	35	0.02											SDA 4...
SXG 440 142 R ...	■	■	□	1.42	7.5	4	1.28	0.71	40	0.02											SDA 4...
SXG 435 192 R ...	■	■	□	1.92	6	4	1.73	0.96	35	0.02											SDA 4...
SXG 440 192 R ...	■	■	□	1.92	10	4	1.73	0.96	40	0.02											SDA 4...
SXG 435 242 R ...	■	■	□	2.42	7.5	4	2.18	1.21	35	0.02											SDA 4...
SXG 440 242 R ...	■	■	□	2.42	12.5	4	2.18	1.21	40	0.02											SDA 4...
SXG 440 292 R ...	■	■	□	2.92	9	4	2.63	1.46	40	0.02											SDA 4...
SXG 448 292 R ...	■	■	□	2.92	15	4	2.63	1.46	48	0.02											SDA 4...
SXG 440 342 R ...	■	■	□	3.42	10.5	4	3.08	1.71	40	0.02											SDA 4...
SXG 448 342 R ...	■	■	□	3.42	17.5	4	3.08	1.71	48	0.02											SDA 4...
SXG 440 392 R ...	■	■	□	3.92	12	4	3.53	1.96	40	0.02											SDA 4...
SXG 448 392 R ...	■	■	□	3.92	20	4	3.53	1.96	48	0.02											SDA 4...
SXG 644 442 R ...	■	■	□	4.42	9	6	3.98	2.21	44	0.02											SDA 6...
SXG 656 442 R ...	■	■	□	4.42	18	6	3.98	2.21	56	0.02											SDA 6...
SXG 668 442 R ...	■	■	□	4.42	27	6	3.98	2.21	68	0.02											SDA 6...
SXG 644 492 R ...	■	■	□	4.92	10	6	4.43	2.46	44	0.02											SDA 6...
SXG 656 492 R ...	■	■	□	4.92	20	6	4.43	2.46	56	0.02											SDA 6...
SXG 668 492 R ...	■	■	□	4.92	30	6	4.43	2.46	68	0.02											SDA 6...
SXG 644 542 R ...	■	■	□	5.42	11	6	4.88	2.71	44	0.02											SDA 6...
SXG 656 542 R ...	■	■	□	5.42	22	6	4.88	2.71	56	0.02											SDA 6...
SXG 668 542 R ...	■	■	□	5.42	33	6	4.88	2.71	68	0.02											SDA 6...
SXG 644 592 R ...	■	■	□	5.92	12	6	5.33	2.96	44	0.02											SDA 6...
SXG 656 592 R ...	■	■	□	5.92	24	6	5.33	2.96	56	0.02											SDA 6...
SXG 668 592 R ...	■	■	□	5.92	36	6	5.33	2.96	68	0.02											SDA 6...
SXG 850 692 R ...	■	■	□	6.92	14	8	6.23	3.46	50	0.02											SDA 8...
SXG 866 692 R ...	■	■	□	6.92	28	8	6.23	3.46	66	0.02											SDA 8...
SXG 882 692 R ...	■	■	□	6.92	42	8	6.23	3.46	82	0.02											SDA 8...
SXG 850 792 R ...	■	■	□	7.92	16	8	7.13	3.96	50	0.02											SDA 8...
SXG 866 792 R ...	■	■	□	7.92	32	8	7.13	3.96	66	0.02											SDA 8...
SXG 882 792 R ...	■	■	□	7.92	48	8	7.13	3.96	82	0.02											SDA 8...

* Left execution and other coatings on demand

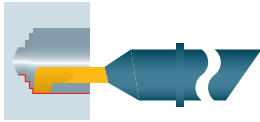

Turning and facing

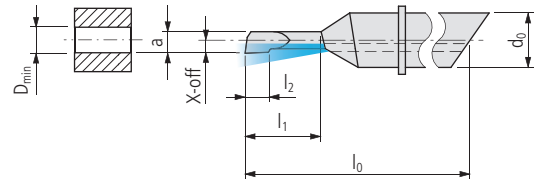
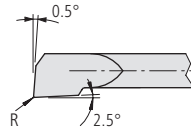

SDI ...

Order designation	Carbide			Dimensions							Holder	
	UHM 20	UHM 20 HX	UHM 20 TX+	D _{min}	l ₁	d ₀	a	X-off	l ₀	l ₂	R	360...
R *	○	●	●									
	○	●	●									
	○	●	●									
	●	○	-									
	-	○	○									

PREMIUM-LINE

SDI 435 042 R ...	■	■	□	0.42	1.5	4	0.38	0.21	35	0.5	0.02				SDA 4...
SDI 435 052 R ...	■	■	□	0.52	1.8	4	0.47	0.26	35	0.6	0.02				SDA 4...
SDI 435 072 R ...	■	■	□	0.72	2.4	4	0.65	0.36	35	0.8	0.02				SDA 4...
SDI 435 092 R ...	■	■	□	0.92	3	4	0.83	0.46	35	1	0.02				SDA 4...
SDI 440 092 R ...	■	■	□	0.92	3	4	0.83	0.46	40	1	0.02				SDA 4...
SDI 448 092 R ...	■	■	□	0.92	5	4	0.83	0.46	48	1	0.02				SDA 4...
SDI 435 122 R ...	■	■	□	1.22	3.9	4	1.10	0.61	35	1.3	0.02				SDA 4...
SDI 435 142 R ...	■	■	□	1.42	4.5	4	1.28	0.71	35	1.5	0.02				SDA 4...
SDI 440 142 R ...	■	■	□	1.42	4.5	4	1.28	0.71	40	1.5	0.02				SDA 4...
SDI 448 142 R ...	■	■	□	1.42	7.5	4	1.28	0.71	48	1.5	0.02				SDA 4...
SDI 435 192 R ...	■	■	□	1.92	6	4	1.73	0.96	35	2	0.02				SDA 4...
SDI 440 192 R ...	■	■	□	1.92	6	4	1.73	0.96	40	2	0.02				SDA 4...
SDI 448 192 R ...	■	■	□	1.92	10	4	1.73	0.96	48	2	0.02				SDA 4...
SDI 435 242 R ...	■	■	□	2.42	7.5	4	2.18	1.21	35	2.5	0.02				SDA 4...
SDI 440 242 R ...	■	■	□	2.42	7.5	4	2.18	1.21	40	2.5	0.02				SDA 4...
SDI 448 242 R ...	■	■	□	2.42	12.5	4	2.18	1.21	48	2.5	0.02				SDA 4...
SDI 440 292 R ...	■	■	□	2.92	9	4	2.63	1.46	40	3	0.02				SDA 4...
SDI 448 292 R ...	■	■	□	2.92	15	4	2.63	1.46	48	3	0.02				SDA 4...
SDI 440 342 R ...	■	■	□	3.42	10.5	4	3.08	1.71	40	3.5	0.02				SDA 4...
SDI 448 342 R ...	■	■	□	3.42	17.5	4	3.08	1.71	48	3.5	0.02				SDA 4...
SDI 440 392 R ...	■	■	□	3.92	12	4	3.53	1.96	40	4	0.02				SDA 4...
SDI 448 392 R ...	■	■	□	3.92	20	4	3.53	1.96	48	4	0.02				SDA 4...
SDI 644 442 R ...	■	■	□	4.42	9	6	3.98	2.21	44	4.5	0.02				SDA 6...
SDI 656 442 R ...	■	■	□	4.42	18	6	3.98	2.21	56	4.5	0.02				SDA 6...
SDI 668 442 R ...	■	■	□	4.42	27	6	3.98	2.21	68	4.5	0.02				SDA 6...
SDI 644 492 R ...	■	■	□	4.92	10	6	4.43	2.46	44	5	0.02				SDA 6...
SDI 656 492 R ...	■	■	□	4.92	20	6	4.43	2.46	56	5	0.02				SDA 6...
SDI 668 492 R ...	■	■	□	4.92	30	6	4.43	2.46	68	5	0.02				SDA 6...
SDI 644 542 R ...	■	■	□	5.42	11	6	4.88	2.71	44	5.5	0.02				SDA 6...
SDI 656 542 R ...	■	■	□	5.42	22	6	4.88	2.71	56	5.5	0.02				SDA 6...
SDI 668 542 R ...	■	■	□	5.42	33	6	4.88	2.71	68	5.5	0.02				SDA 6...
SDI 644 592 R ...	■	■	□	5.92	12	6	5.33	2.96	44	6	0.02				SDA 6...
SDI 656 592 R ...	■	■	□	5.92	24	6	5.33	2.96	56	6	0.02				SDA 6...
SDI 668 592 R ...	■	■	□	5.92	36	6	5.33	2.96	68	6	0.02				SDA 6...
SDI 850 692 R ...	■	■	□	6.92	14	8	6.23	3.46	50	7	0.02				SDA 8...
SDI 866 692 R ...	■	■	□	6.92	28	8	6.23	3.46	66	7	0.02				SDA 8...
SDI 882 692 R ...	■	■	□	6.92	42	8	6.23	3.46	82	7	0.02				SDA 8...
SDI 850 792 R ...	■	■	□	7.92	16	8	7.13	3.96	50	8	0.02				SDA 8...
SDI 866 792 R ...	■	■	□	7.92	32	8	7.13	3.96	66	8	0.02				SDA 8...
SDI 882 792 R ...	■	■	□	7.92	48	8	7.13	3.96	82	8	0.02				SDA 8...

* Left execution and other coatings on demand

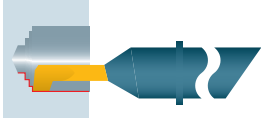

Turning and facing
Strengthen type (for blind holes)

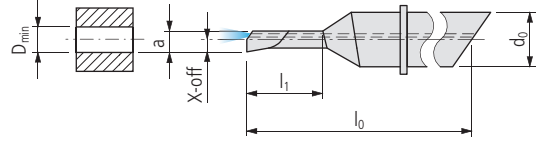
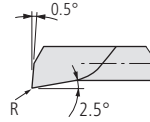

342

UTILIS
multidec
swiss type tools

SXI ...

Order designation	Carbide □ 20			Dimensions							Holder
	UHM 20	UHM 20 HX	UHM 20 TX+	D _{min}	l ₁	d ₀	a	X-off	l ₀	R	□ 360...
R *	○	●	●								
	○	●	●								
	○	●	●								
	○	●	●								
	○	●	●								
	○	●	●								
	○	●	●								
	○	●	●								
	○	●	●								

PREMIUM-LINE

SXI 435 042 R ...	■	■	□	0.42	1.5	4	0.38	0.21	35	0.02							SDA 4...
SXI 435 052 R ...	■	■	□	0.52	2	4	0.47	0.26	35	0.02							SDA 4...
SXI 435 072 R ...	■	■	□	0.72	2.5	4	0.65	0.36	35	0.02							SDA 4...
SXI 435 092 R ...	■	■	□	0.92	3	4	0.83	0.46	35	0.02							SDA 4...
SXI 440 092 R ...	■	■	□	0.92	5	4	0.83	0.46	40	0.02							SDA 4...
SXI 435 122 R ...	■	■	□	1.22	4	4	1.1	0.61	35	0.02							SDA 4...
SXI 435 142 R ...	■	■	□	1.42	4.5	4	1.28	0.71	35	0.02							SDA 4...
SXI 440 142 R ...	■	■	□	1.42	7.5	4	1.28	0.71	40	0.02							SDA 4...
SXI 435 192 R ...	■	■	□	1.92	6	4	1.73	0.96	35	0.02							SDA 4...
SXI 440 192 R ...	■	■	□	1.92	10	4	1.73	0.96	40	0.02							SDA 4...
SXI 435 242 R ...	■	■	□	2.42	7.5	4	2.18	1.21	35	0.02							SDA 4...
SXI 440 242 R ...	■	■	□	2.42	12.5	4	2.18	1.21	40	0.02							SDA 4...
SXI 440 292 R ...	■	■	□	2.92	9	4	2.63	1.46	40	0.02							SDA 4...
SXI 448 292 R ...	■	■	□	2.92	15	4	2.63	1.46	48	0.02							SDA 4...
SXI 440 342 R ...	■	■	□	3.42	10.5	4	3.08	1.71	40	0.02							SDA 4...
SXI 448 342 R ...	■	■	□	3.42	17.5	4	3.08	1.71	48	0.02							SDA 4...
SXI 440 392 R ...	■	■	□	3.92	12	4	3.53	1.96	40	0.02							SDA 4...
SXI 448 392 R ...	■	■	□	3.92	20	4	3.53	1.96	48	0.02							SDA 4...
SXI 644 442 R ...	■	■	□	4.42	9	6	3.98	2.21	44	0.02							SDA 6...
SXI 656 442 R ...	■	■	□	4.42	18	6	3.98	2.21	56	0.02							SDA 6...
SXI 668 442 R ...	■	■	□	4.42	27	6	3.98	2.21	68	0.02							SDA 6...
SXI 644 492 R ...	■	■	□	4.92	10	6	4.43	2.46	44	0.02							SDA 6...
SXI 656 492 R ...	■	■	□	4.92	20	6	4.43	2.46	56	0.02							SDA 6...
SXI 668 492 R ...	■	■	□	4.92	30	6	4.43	2.46	68	0.02							SDA 6...
SXI 644 542 R ...	■	■	□	5.42	11	6	4.88	2.71	44	0.02							SDA 6...
SXI 656 542 R ...	■	■	□	5.42	22	6	4.88	2.71	56	0.02							SDA 6...
SXI 668 542 R ...	■	■	□	5.42	33	6	4.88	2.71	68	0.02							SDA 6...
SXI 644 592 R ...	■	■	□	5.92	12	6	5.33	2.96	44	0.02							SDA 6...
SXI 656 592 R ...	■	■	□	5.92	24	6	5.33	2.96	56	0.02							SDA 6...
SXI 668 592 R ...	■	■	□	5.92	36	6	5.33	2.96	68	0.02							SDA 6...
SXI 850 692 R ...	■	■	□	6.92	14	8	6.23	3.46	50	0.02							SDA 8...
SXI 866 692 R ...	■	■	□	6.92	28	8	6.23	3.46	66	0.02							SDA 8...
SXI 882 692 R ...	■	■	□	6.92	42	8	6.23	3.46	82	0.02							SDA 8...
SXI 850 792 R ...	■	■	□	7.92	16	8	7.13	3.96	50	0.02							SDA 8...
SXI 866 792 R ...	■	■	□	7.92	32	8	7.13	3.96	66	0.02							SDA 8...
SXI 882 792 R ...	■	■	□	7.92	48	8	7.13	3.96	82	0.02							SDA 8...

* Left execution and other coatings on demand

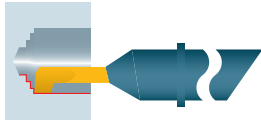

Turning and facing

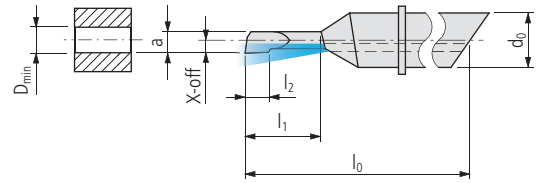
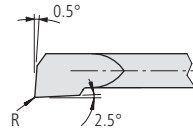

SDF ...

Order designation	Carbide			20	Dimensions							Holder			
	UHM 20	UHM 20 HX	UHM 20 TX+		D _{min}	l ₁	d ₀	a	X-off	l ₀	l ₂		R		
R	○	●	●												360...

PREMIUM-LINE

SDF 435 042 R ...	■	■	□	0.42	1.5	4	0.38	0.21	35	0.5	0.06					SDA 4...
SDF 435 092 R ...	■	■	□	0.92	3	4	0.83	0.46	35	1	0.06					SDA 4...
SDF 440 092 R ...	■	■	□	0.92	3	4	0.83	0.46	40	1	0.06					SDA 4...
SDF 448 092 R ...	■	■	□	0.92	5	4	0.83	0.46	48	1	0.06					SDA 4...
SDF 435 142 R ...	■	■	□	1.42	4.5	4	1.28	0.71	35	1.5	0.06					SDA 4...
SDF 440 142 R ...	■	■	□	1.42	4.5	4	1.28	0.71	40	1.5	0.06					SDA 4...
SDF 448 142 R ...	■	■	□	1.42	7.5	4	1.28	0.71	48	1.5	0.06					SDA 4...
SDF 435 192 R ...	■	■	□	1.92	6	4	1.73	0.96	35	2	0.06					SDA 4...
SDF 440 192 R ...	■	■	□	1.92	6	4	1.73	0.96	40	2	0.06					SDA 4...
SDF 448 192 R ...	■	■	□	1.92	10	4	1.73	0.96	48	2	0.06					SDA 4...
SDF 435 242 R ...	■	■	□	2.42	7.5	4	2.18	1.21	35	2.5	0.06					SDA 4...
SDF 440 242 R ...	■	■	□	2.42	7.5	4	2.18	1.21	40	2.5	0.06					SDA 4...
SDF 448 242 R ...	■	■	□	2.42	12.5	4	2.18	1.21	48	2.5	0.06					SDA 4...
SDF 440 292 R ...	■	■	□	2.92	9	4	2.63	1.46	40	3	0.06					SDA 4...
SDF 448 292 R ...	■	■	□	2.92	15	4	2.63	1.46	48	3	0.06					SDA 4...
SDF 440 342 R ...	■	■	□	3.42	10.5	4	3.08	1.71	40	3.5	0.06					SDA 4...
SDF 448 342 R ...	■	■	□	3.42	17.5	4	3.08	1.71	48	3.5	0.06					SDA 4...
SDF 440 392 R ...	■	■	□	3.92	12	4	3.53	1.96	40	4	0.06					SDA 4...
SDF 448 392 R ...	■	■	□	3.92	20	4	3.53	1.96	48	4	0.06					SDA 4...
SDF 644 442 R ...	■	■	□	4.42	9	6	3.98	2.21	44	4.5	0.08					SDA 6...
SDF 656 442 R ...	■	■	□	4.42	18	6	3.98	2.21	56	4.5	0.08					SDA 6...
SDF 668 442 R ...	■	■	□	4.42	27	6	3.98	2.21	68	4.5	0.08					SDA 6...
SDF 644 492 R ...	■	■	□	4.92	10	6	4.43	2.46	44	5	0.08					SDA 6...
SDF 656 492 R ...	■	■	□	4.92	20	6	4.43	2.46	56	5	0.08					SDA 6...
SDF 668 492 R ...	■	■	□	4.92	30	6	4.43	2.46	68	5	0.08					SDA 6...
SDF 644 542 R ...	■	■	□	5.42	11	6	4.88	2.71	44	5.5	0.08					SDA 6...
SDF 656 542 R ...	■	■	□	5.42	22	6	4.88	2.71	56	5.5	0.08					SDA 6...
SDF 668 542 R ...	■	■	□	5.42	33	6	4.88	2.71	68	5.5	0.08					SDA 6...
SDF 644 592 R ...	■	■	□	5.92	12	6	5.33	2.96	44	6	0.08					SDA 6...
SDF 656 592 R ...	■	■	□	5.92	24	6	5.33	2.96	56	6	0.08					SDA 6...
SDF 668 592 R ...	■	■	□	5.92	36	6	5.33	2.96	68	6	0.08					SDA 6...
SDF 850 692 R ...	■	■	□	6.92	14	8	6.23	3.46	50	7	0.12					SDA 8...
SDF 866 692 R ...	■	■	□	6.92	28	8	6.23	3.46	66	7	0.12					SDA 8...
SDF 882 692 R ...	■	■	□	6.92	42	8	6.23	3.46	82	7	0.12					SDA 8...
SDF 850 792 R ...	■	■	□	7.92	16	8	3.96	3.96	50	8	0.12					SDA 8...
SDF 866 792 R ...	■	■	□	7.92	32	8	3.96	3.96	66	8	0.12					SDA 8...
SDF 882 792 R ...	■	■	□	7.92	48	8	3.96	3.96	82	8	0.12					SDA 8...

* Left execution and other coatings on demand

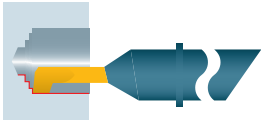

Turning and facing
Strengthen type (for blind holes)

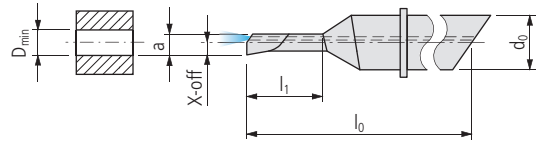
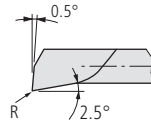

SXF ...

Order designation	Carbide	□ 20	Dimensions								Holder
	○	●	D _{min}	l ₁	d ₀	a	X-off	l ₀	R		□ 360...
R	UHM 20	UHM 20 HX									
*	UHM 20 TX+										

PREMIUM-LINE

SXF 435 042 R ...	■	■	□	0.42	1.5	4	0.38	0.21	35	0.06			SDA 4...
SXF 435 092 R ...	■	■	□	0.92	3	4	0.83	0.46	35	0.06			SDA 4...
SXF 440 092 R ...	■	■	□	0.92	5	4	0.83	0.46	40	0.06			SDA 4...
SXF 435 142 R ...	■	■	□	1.42	4.5	4	1.28	0.71	35	0.06			SDA 4...
SXF 440 142 R ...	■	■	□	1.42	7.5	4	1.28	0.71	40	0.06			SDA 4...
SXF 435 192 R ...	■	■	□	1.92	6	4	1.73	0.96	35	0.06			SDA 4...
SXF 440 192 R ...	■	■	□	1.92	10	4	1.73	0.96	40	0.06			SDA 4...
SXF 435 242 R ...	■	■	□	2.42	7.5	4	2.18	1.21	35	0.06			SDA 4...
SXF 440 242 R ...	■	■	□	2.42	12.5	4	2.18	1.21	40	0.06			SDA 4...
SXF 440 292 R ...	■	■	□	2.92	9	4	2.63	1.46	40	0.06			SDA 4...
SXF 448 292 R ...	■	■	□	2.92	15	4	2.63	1.46	48	0.06			SDA 4...
SXF 440 342 R ...	■	■	□	3.42	10.5	4	3.08	1.71	40	0.06			SDA 4...
SXF 448 342 R ...	■	■	□	3.42	17.5	4	3.08	1.71	48	0.06			SDA 4...
SXF 440 392 R ...	■	■	□	3.92	12	4	3.53	1.96	40	0.06			SDA 4...
SXF 448 392 R ...	■	■	□	3.92	20	4	3.53	1.96	48	0.06			SDA 4...
SXF 644 442 R ...	■	■	□	4.42	9	6	3.98	2.21	44	0.08			SDA 6...
SXF 656 442 R ...	■	■	□	4.42	18	6	3.98	2.21	56	0.08			SDA 6...
SXF 668 442 R ...	■	■	□	4.42	27	6	3.98	2.21	68	0.08			SDA 6...
SXF 644 492 R ...	■	■	□	4.92	10	6	4.43	2.46	44	0.08			SDA 6...
SXF 656 492 R ...	■	■	□	4.92	20	6	4.43	2.46	56	0.08			SDA 6...
SXF 668 492 R ...	■	■	□	4.92	30	6	4.43	2.46	68	0.08			SDA 6...
SXF 644 542 R ...	■	■	□	5.42	11	6	4.88	2.71	44	0.08			SDA 6...
SXF 656 542 R ...	■	■	□	5.42	22	6	4.88	2.71	56	0.08			SDA 6...
SXF 668 542 R ...	■	■	□	5.42	33	6	4.88	2.71	68	0.08			SDA 6...
SXF 644 592 R ...	■	■	□	5.92	12	6	5.33	2.96	44	0.08			SDA 6...
SXF 656 592 R ...	■	■	□	5.92	24	6	5.33	2.96	56	0.08			SDA 6...
SXF 668 592 R ...	■	■	□	5.92	36	6	5.33	2.96	68	0.08			SDA 6...
SXF 850 692 R ...	■	■	□	6.92	14	8	6.23	3.46	50	0.12			SDA 8...
SXF 866 692 R ...	■	■	□	6.92	28	8	6.23	3.46	66	0.12			SDA 8...
SXF 882 692 R ...	■	■	□	6.92	42	8	6.23	3.46	82	0.12			SDA 8...
SXF 850 792 R ...	■	■	□	7.92	16	8	7.13	3.96	50	0.12			SDA 8...
SXF 866 792 R ...	■	■	□	7.92	32	8	7.13	3.96	66	0.12			SDA 8...
SXF 882 792 R ...	■	■	□	7.92	48	8	7.13	3.96	82	0.12			SDA 8...

* Left execution and other coatings on demand

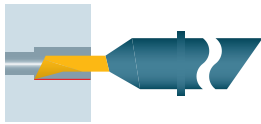

Front turning



SDH ...

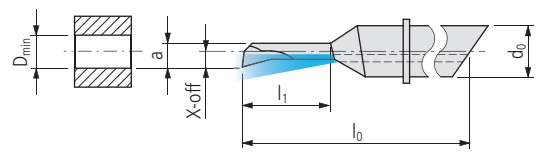
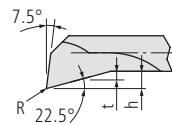

Order designation	Carbide			20	Dimensions											Holder	
	UHM 20	UHM 20 HX	UHM 20 TX+		D _{min}	l ₁	d ₀	a	X-off	h	t	l ₀	R				

PREMIUM-LINE

SDH 435 042 R ...	■	■	□	0.42	1.5	4	0.38	0.21	0.09	0.07	35	0.05							SDA 4...
SDH 435 092 R ...	■	■	□	0.92	3	4	0.83	0.46	0.19	0.15	35	0.05							SDA 4...
SDH 440 092 R ...	■	■	□	0.92	3	4	0.83	0.46	0.19	0.15	40	0.05							SDA 4...
SDH 448 092 R ...	■	■	□	0.92	5	4	0.83	0.46	0.19	0.15	48	0.05							SDA 4...
SDH 435 142 R ...	■	■	□	1.42	4.5	4	1.28	0.71	0.3	0.23	35	0.05							SDA 4...
SDH 440 142 R ...	■	■	□	1.42	4.5	4	1.28	0.71	0.3	0.23	40	0.05							SDA 4...
SDH 448 142 R ...	■	■	□	1.42	7.5	4	1.28	0.71	0.3	0.23	48	0.05							SDA 4...
SDH 435 192 R ...	■	■	□	1.92	6	4	1.73	0.96	0.4	0.31	35	0.05							SDA 4...
SDH 440 192 R ...	■	■	□	1.92	6	4	1.73	0.96	0.4	0.31	40	0.05							SDA 4...
SDH 448 192 R ...	■	■	□	1.92	10	4	1.73	0.96	0.4	0.31	48	0.05							SDA 4...
SDH 435 242 R ...	■	■	□	2.42	7.5	4	2.18	1.21	0.51	0.39	35	0.05							SDA 4...
SDH 440 242 R ...	■	■	□	2.42	7.5	4	2.18	1.21	0.51	0.39	40	0.05							SDA 4...
SDH 448 242 R ...	■	■	□	2.42	12.5	4	2.18	1.21	0.51	0.39	48	0.05							SDA 4...
SDH 440 292 R ...	■	■	□	2.92	9	4	2.63	1.46	0.61	0.47	40	0.05							SDA 4...
SDH 448 292 R ...	■	■	□	2.92	15	4	2.63	1.46	0.61	0.47	48	0.05							SDA 4...
SDH 440 342 R ...	■	■	□	3.42	10.5	4	3.08	1.71	0.72	0.55	40	0.05							SDA 4...
SDH 448 342 R ...	■	■	□	3.42	17.5	4	3.08	1.71	0.72	0.55	48	0.05							SDA 4...
SDH 440 392 R ...	■	■	□	3.92	12	4	3.53	1.96	0.82	0.63	40	0.05							SDA 4...
SDH 448 392 R ...	■	■	□	3.92	20	4	3.53	1.96	0.82	0.63	48	0.05							SDA 4...
SDH 644 442 R ...	■	■	□	4.42	9	6	3.98	2.21	0.93	0.71	44	0.05							SDA 6...
SDH 656 442 R ...	■	■	□	4.42	18	6	3.98	2.21	0.93	0.71	56	0.05							SDA 6...
SDH 668 442 R ...	■	■	□	4.42	27	6	3.98	2.21	0.93	0.71	68	0.05							SDA 6...
SDH 644 492 R ...	■	■	□	4.92	10	6	4.43	2.46	1.03	0.79	44	0.05							SDA 6...
SDH 656 492 R ...	■	■	□	4.92	20	6	4.43	2.46	1.03	0.79	56	0.05							SDA 6...
SDH 668 492 R ...	■	■	□	4.92	30	6	4.43	2.46	1.03	0.79	68	0.05							SDA 6...
SDH 644 542 R ...	■	■	□	5.42	11	6	4.88	2.71	1.14	0.87	44	0.05							SDA 6...
SDH 656 542 R ...	■	■	□	5.42	22	6	4.88	2.71	1.14	0.87	56	0.05							SDA 6...
SDH 668 542 R ...	■	■	□	5.42	33	6	4.88	2.71	1.14	0.87	68	0.05							SDA 6...
SDH 644 592 R ...	■	■	□	5.92	12	6	5.33	2.96	1.24	0.95	44	0.05							SDA 6...
SDH 656 592 R ...	■	■	□	5.92	24	6	5.33	2.96	1.24	0.95	56	0.05							SDA 6...
SDH 668 592 R ...	■	■	□	5.92	36	6	5.33	2.96	1.24	0.95	68	0.05							SDA 6...
SDH 850 692 R ...	■	■	□	6.92	14	8	6.23	3.46	1.45	1.11	50	0.05							SDA 8...
SDH 866 692 R ...	■	■	□	6.92	28	8	6.23	3.46	1.45	1.11	66	0.05							SDA 8...
SDH 882 692 R ...	■	■	□	6.92	42	8	6.23	3.46	1.45	1.11	82	0.05							SDA 8...
SDH 850 792 R ...	■	■	□	7.92	16	8	7.13	3.96	1.66	1.27	50	0.05							SDA 8...
SDH 866 792 R ...	■	■	□	7.92	32	8	7.13	3.96	1.66	1.27	66	0.05							SDA 8...
SDH 882 792 R ...	■	■	□	7.92	48	8	7.13	3.96	1.66	1.27	82	0.05							SDA 8...

* Left execution and other coatings on demand

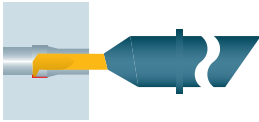

Turning and front turning

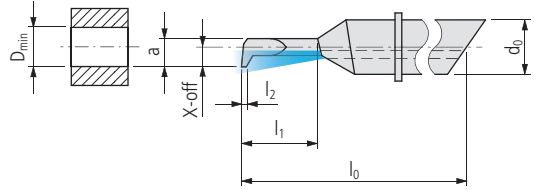
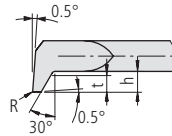

SDK ...

Order designation	Carbide □ 20			Dimensions										Holder
	UHM 20	UHM 20 HX	UHM 20 TX+	D _{min}	l ₁	d ₀	a	X-off	h	t	l ₀	l ₂	R	□ 360...
R *	○	○	○											

PREMIUM-LINE

SDK 435 092 R ...	■	■	□	0.92	3	4	0.83	0.46	0.23	0.15	35	0.5	0.02	SDA 4...
SDK 440 092 R ...	■	■	□	0.92	3	4	0.83	0.46	0.23	0.15	40	0.5	0.02	SDA 4...
SDK 448 092 R ...	■	■	□	0.92	5	4	0.83	0.46	0.23	0.15	48	0.5	0.02	SDA 4...
SDK 435 142 R ...	■	■	□	1.42	4.5	4	1.28	0.71	0.36	0.23	35	0.75	0.02	SDA 4...
SDK 440 142 R ...	■	■	□	1.42	4.5	4	1.28	0.71	0.36	0.23	40	0.75	0.02	SDA 4...
SDK 448 142 R ...	■	■	□	1.42	7.5	4	1.28	0.71	0.36	0.23	48	0.75	0.02	SDA 4...
SDK 435 192 R ...	■	■	□	1.92	6	4	1.73	0.96	0.48	0.32	35	1	0.02	SDA 4...
SDK 440 192 R ...	■	■	□	1.92	6	4	1.73	0.96	0.48	0.32	40	1	0.02	SDA 4...
SDK 448 192 R ...	■	■	□	1.92	10	4	1.73	0.96	0.48	0.32	48	1	0.02	SDA 4...
SDK 435 242 R ...	■	■	□	2.42	7.5	4	2.18	1.21	0.61	0.4	35	1.25	0.02	SDA 4...
SDK 440 242 R ...	■	■	□	2.42	7.5	4	2.18	1.21	0.61	0.4	40	1.25	0.02	SDA 4...
SDK 448 242 R ...	■	■	□	2.42	12.5	4	2.18	1.21	0.61	0.4	48	1.25	0.02	SDA 4...
SDK 440 292 R ...	■	■	□	2.92	9	4	2.63	1.46	0.73	0.49	40	1.5	0.02	SDA 4...
SDK 448 292 R ...	■	■	□	2.92	15	4	2.63	1.46	0.73	0.49	48	1.5	0.02	SDA 4...
SDK 440 342 R ...	■	■	□	3.42	10.5	4	3.08	1.71	0.86	0.57	40	1.75	0.02	SDA 4...
SDK 448 342 R ...	■	■	□	3.42	17.5	4	3.08	1.71	0.86	0.57	48	1.75	0.02	SDA 4...
SDK 440 392 R ...	■	■	□	3.92	12	4	3.53	1.96	0.98	0.66	40	2	0.02	SDA 4...
SDK 448 392 R ...	■	■	□	3.92	20	4	3.53	1.96	0.98	0.66	48	2	0.02	SDA 4...
SDK 644 442 R ...	■	■	□	4.42	9	6	3.98	2.21	1.11	0.74	44	2.25	0.02	SDA 6...
SDK 656 442 R ...	■	■	□	4.42	18	6	3.98	2.21	1.11	0.74	56	2.25	0.02	SDA 6...
SDK 668 442 R ...	■	■	□	4.42	27	6	3.98	2.21	1.11	0.74	68	2.25	0.02	SDA 6...
SDK 644 492 R ...	■	■	□	4.92	10	6	4.43	2.46	1.23	0.82	44	2.5	0.02	SDA 6...
SDK 656 492 R ...	■	■	□	4.92	20	6	4.43	2.46	1.23	0.82	56	2.5	0.02	SDA 6...
SDK 668 492 R ...	■	■	□	4.92	30	6	4.43	2.46	1.23	0.82	68	2.5	0.02	SDA 6...
SDK 644 542 R ...	■	■	□	5.42	11	6	4.88	2.71	1.36	0.9	44	2.75	0.02	SDA 6...
SDK 656 542 R ...	■	■	□	5.42	22	6	4.88	2.71	1.36	0.9	56	2.75	0.02	SDA 6...
SDK 668 542 R ...	■	■	□	5.42	33	6	4.88	2.71	1.36	0.9	68	2.75	0.02	SDA 6...
SDK 644 592 R ...	■	■	□	5.92	12	6	5.33	2.96	1.48	0.99	44	3	0.02	SDA 6...
SDK 656 592 R ...	■	■	□	5.92	24	6	5.33	2.96	1.48	0.99	56	3	0.02	SDA 6...
SDK 668 592 R ...	■	■	□	5.92	36	6	5.33	2.96	1.48	0.99	68	3	0.02	SDA 6...
SDK 850 692 R ...	■	■	□	6.92	14	8	6.23	3.46	1.73	1.15	50	3.5	0.02	SDA 8...
SDK 866 692 R ...	■	■	□	6.92	28	8	6.23	3.46	1.73	1.15	66	3.5	0.02	SDA 8...
SDK 882 692 R ...	■	■	□	6.92	42	8	6.23	3.46	1.73	1.15	82	3.5	0.02	SDA 8...
SDK 850 792 R ...	■	■	□	7.92	16	8	7.13	3.96	1.98	1.32	50	4	0.02	SDA 8...
SDK 866 792 R ...	■	■	□	7.92	32	8	7.13	3.96	1.98	1.32	66	4	0.02	SDA 8...
SDK 882 792 R ...	■	■	□	7.92	48	8	7.13	3.96	1.98	1.32	82	4	0.02	SDA 8...

* Left execution and other coatings on demand

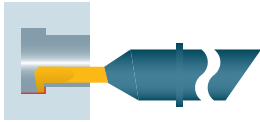

Back turning

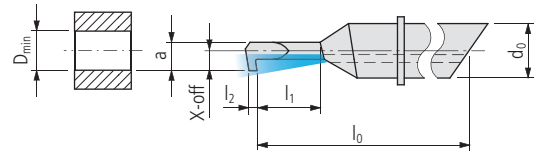
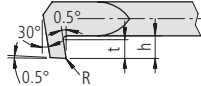

SDM ...

Order designation	Carbide □ 20			Dimensions									Holder	
	UHM 20	UHM 20 HX	UHM 20 TX+	D _{min}	l ₁	d ₀	a	X-off	h	t	l ₀	l ₂	R	□ 360...
R *	●	●	●											

PREMIUM-LINE

SDM 435 092 R ...	■	■	□	0.92	3	4	0.83	0.46	0.23	0.15	35	0.5	0.01	SDA 4...
SDM 440 092 R ...	■	■	□	0.92	3	4	0.83	0.46	0.23	0.15	40	0.5	0.01	SDA 4...
SDM 448 092 R ...	■	■	□	0.92	5	4	0.83	0.46	0.23	0.15	48	0.5	0.01	SDA 4...
SDM 435 142 R ...	■	■	□	1.42	4.5	4	1.28	0.71	0.36	0.23	35	0.75	0.01	SDA 4...
SDM 440 142 R ...	■	■	□	1.42	4.5	4	1.28	0.71	0.36	0.23	40	0.75	0.01	SDA 4...
SDM 448 142 R ...	■	■	□	1.42	7.5	4	1.28	0.71	0.36	0.23	48	0.75	0.01	SDA 4...
SDM 435 192 R ...	■	■	□	1.92	6	4	1.73	0.96	0.48	0.32	35	1	0.01	SDA 4...
SDM 440 192 R ...	■	■	□	1.92	6	4	1.73	0.96	0.48	0.33	40	1	0.01	SDA 4...
SDM 448 192 R ...	■	■	□	1.92	10	4	1.73	0.96	0.48	0.33	48	1	0.01	SDA 4...
SDM 435 242 R ...	■	■	□	2.42	7.5	4	2.18	1.21	0.61	0.4	35	1.25	0.02	SDA 4...
SDM 440 242 R ...	■	■	□	2.42	7.5	4	2.18	1.21	0.61	0.4	40	1.25	0.02	SDA 4...
SDM 448 242 R ...	■	■	□	2.42	12.5	4	2.18	1.21	0.61	0.4	48	1.25	0.02	SDA 4...
SDM 440 292 R ...	■	■	□	2.92	9	4	2.63	1.46	0.73	0.49	40	1.5	0.02	SDA 4...
SDM 448 292 R ...	■	■	□	2.92	15	4	2.63	1.46	0.73	0.49	48	1.5	0.02	SDA 4...
SDM 440 342 R ...	■	■	□	3.42	10.5	4	3.08	1.71	0.86	0.57	40	1.75	0.02	SDA 4...
SDM 448 342 R ...	■	■	□	3.42	17.5	4	3.08	1.71	0.86	0.57	48	1.75	0.02	SDA 4...
SDM 440 392 R ...	■	■	□	3.92	12	4	3.53	1.96	0.98	0.66	40	2	0.02	SDA 4...
SDM 448 392 R ...	■	■	□	3.92	20	4	3.53	1.96	0.98	0.66	48	2	0.02	SDA 4...
SDM 644 442 R ...	■	■	□	4.42	9	6	3.98	2.21	1.11	0.74	44	2.25	0.03	SDA 6...
SDM 656 442 R ...	■	■	□	4.42	18	6	3.98	2.21	1.11	0.74	56	2.25	0.03	SDA 6...
SDM 668 442 R ...	■	■	□	4.42	27	6	3.98	2.21	1.11	0.74	68	2.25	0.03	SDA 6...
SDM 644 492 R ...	■	■	□	4.92	10	6	4.43	2.46	1.23	0.82	44	2.5	0.03	SDA 6...
SDM 656 492 R ...	■	■	□	4.92	20	6	4.43	2.46	1.23	0.82	56	2.5	0.03	SDA 6...
SDM 668 492 R ...	■	■	□	4.92	30	6	4.43	2.46	1.23	0.82	68	2.5	0.03	SDA 6...
SDM 644 542 R ...	■	■	□	5.42	11	6	4.88	2.71	1.36	0.9	44	2.75	0.03	SDA 6...
SDM 656 542 R ...	■	■	□	5.42	22	6	4.88	2.71	1.36	0.9	56	2.75	0.03	SDA 6...
SDM 668 542 R ...	■	■	□	5.42	33	6	4.88	2.71	1.36	0.9	68	2.75	0.03	SDA 6...
SDM 644 592 R ...	■	■	□	5.92	12	6	5.33	2.96	1.48	0.99	44	3	0.03	SDA 6...
SDM 656 592 R ...	■	■	□	5.92	24	6	5.33	2.96	1.48	0.99	56	3	0.03	SDA 6...
SDM 668 592 R ...	■	■	□	5.92	36	6	5.33	2.96	1.48	0.99	68	3	0.03	SDA 6...
SDM 850 692 R ...	■	■	□	6.92	14	8	6.23	3.46	1.73	1.15	50	3.5	0.04	SDA 8...
SDM 866 692 R ...	■	■	□	6.92	28	8	6.23	3.46	1.73	1.15	66	3.5	0.04	SDA 8...
SDM 882 692 R ...	■	■	□	6.92	42	8	6.23	3.46	1.73	1.15	82	3.5	0.04	SDA 8...
SDM 850 792 R ...	■	■	□	7.92	16	8	7.13	3.96	1.98	1.32	50	4	0.04	SDA 8...
SDM 866 792 R ...	■	■	□	7.92	32	8	7.13	3.96	1.98	1.32	66	4	0.04	SDA 8...
SDM 882 792 R ...	■	■	□	7.92	48	8	7.13	3.96	1.98	1.32	82	4	0.04	SDA 8...

* Left execution and other coatings on demand

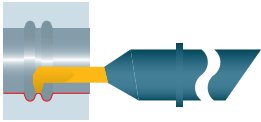

Turning

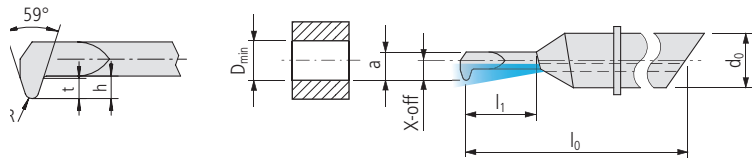

SDO ...

Order designation	Carbide □ 20			Dimensions								Holder	
	UHM 20	UHM 20 HX	UHM 20 TX+	D _{min}	l ₁	d ₀	a	X-off	h	t	l ₀	R	□ 360...
R *	○	○	○										
	○	○	○										
	○	○	○										
	○	○	○										
	○	○	○										

PREMIUM-LINE

SDO 435 092 R ...	■	■	□	0.92	3	4	0.83	0.46	0.31	0.23	35	0.05				SDA 4...
SDO 440 092 R ...	■	■	□	0.92	3	4	0.83	0.46	0.31	0.23	40	0.05				SDA 4...
SDO 448 092 R ...	■	■	□	0.92	5	4	0.83	0.46	0.31	0.23	48	0.05				SDA 4...
SDO 435 142 R ...	■	■	□	1.42	4.5	4	1.28	0.71	0.47	0.36	35	0.075				SDA 4...
SDO 440 142 R ...	■	■	□	1.42	4.5	4	1.28	0.71	0.47	0.36	40	0.075				SDA 4...
SDO 448 142 R ...	■	■	□	1.42	7.5	4	1.28	0.71	0.47	0.36	48	0.075				SDA 4...
SDO 435 192 R ...	■	■	□	1.92	6	4	1.73	0.96	0.64	0.48	35	0.1				SDA 4...
SDO 440 192 R ...	■	■	□	1.92	6	4	1.73	0.96	0.64	0.48	40	0.1				SDA 4...
SDO 448 192 R ...	■	■	□	1.92	10	4	1.73	0.96	0.64	0.48	48	0.1				SDA 4...
SDO 435 242 R ...	■	■	□	2.42	7.5	4	2.18	1.21	0.81	0.61	35	0.125				SDA 4...
SDO 440 242 R ...	■	■	□	2.42	7.5	4	2.18	1.21	0.81	0.61	40	0.125				SDA 4...
SDO 448 242 R ...	■	■	□	2.42	12.5	4	2.18	1.21	0.81	0.61	48	0.125				SDA 4...
SDO 440 292 R ...	■	■	□	2.92	9	4	2.63	1.46	0.97	0.73	40	0.15				SDA 4...
SDO 448 292 R ...	■	■	□	2.92	15	4	2.63	1.46	0.97	0.73	48	0.15				SDA 4...
SDO 440 342 R ...	■	■	□	3.42	10.5	4	3.08	1.71	1.14	0.86	40	0.175				SDA 4...
SDO 448 342 R ...	■	■	□	3.42	17.5	4	3.08	1.71	1.14	0.86	48	0.175				SDA 4...
SDO 440 392 R ...	■	■	□	3.92	12	4	3.53	1.96	1.31	0.98	40	0.2				SDA 4...
SDO 448 392 R ...	■	■	□	3.92	20	4	3.53	1.96	1.31	0.98	48	0.2				SDA 4...
SDO 644 442 R ...	■	■	□	4.42	9	6	3.98	2.21	1.47	1.11	44	0.225				SDA 6...
SDO 656 442 R ...	■	■	□	4.42	18	6	3.98	2.21	1.47	1.11	56	0.225				SDA 6...
SDO 668 442 R ...	■	■	□	4.42	27	6	3.98	2.21	1.47	1.11	68	0.225				SDA 6...
SDO 644 492 R ...	■	■	□	4.92	10	6	4.43	2.46	1.64	1.23	44	0.25				SDA 6...
SDO 656 492 R ...	■	■	□	4.92	20	6	4.43	2.46	1.64	1.23	56	0.25				SDA 6...
SDO 668 492 R ...	■	■	□	4.92	30	6	4.43	2.46	1.64	1.23	68	0.25				SDA 6...
SDO 644 542 R ...	■	■	□	5.42	11	6	4.88	2.71	1.8	1.36	44	0.275				SDA 6...
SDO 656 542 R ...	■	■	□	5.42	22	6	4.88	2.71	1.8	1.36	56	0.275				SDA 6...
SDO 668 542 R ...	■	■	□	5.42	33	6	4.88	2.71	1.8	1.36	68	0.275				SDA 6...
SDO 644 592 R ...	■	■	□	5.92	12	6	5.33	2.96	1.97	1.48	44	0.3				SDA 6...
SDO 656 592 R ...	■	■	□	5.92	24	6	5.33	2.96	1.97	1.48	56	0.3				SDA 6...
SDO 668 592 R ...	■	■	□	5.92	36	6	5.33	2.96	1.97	1.48	68	0.3				SDA 6...
SDO 850 692 R ...	■	■	□	6.92	14	8	6.23	3.46	2.3	1.73	50	0.35				SDA 8...
SDO 866 692 R ...	■	■	□	6.92	28	8	6.23	3.46	2.3	1.73	66	0.35				SDA 8...
SDO 882 692 R ...	■	■	□	6.92	42	8	6.23	3.46	2.3	1.73	82	0.35				SDA 8...
SDO 850 792 R ...	■	■	□	7.92	16	8	7.13	3.96	2.64	1.98	50	0.4				SDA 8...
SDO 866 792 R ...	■	■	□	7.92	32	8	7.13	3.96	2.64	1.98	66	0.4				SDA 8...
SDO 882 792 R ...	■	■	□	7.92	48	8	7.13	3.96	2.64	1.98	82	0.4				SDA 8...

* Left execution and other coatings on demand

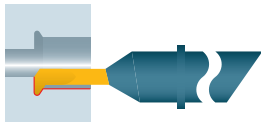

Turning

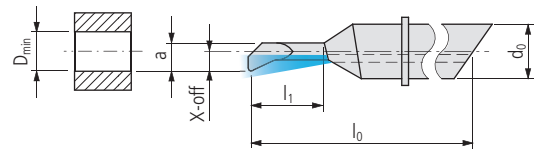
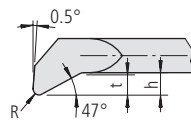

SDQ ...

Order designation	Carbide			Dimensions												Holder	
	UHM 20	UHM 20 HX	UHM 20 TX+	D _{min}	l ₁	d ₀	a	X-off	h	t	l ₀	R				360...	
R *	●	●	●														

PREMIUM-LINE

SDQ 435 092 R ...	■	■	□	0.92	3	4	0.83	0.46	0.31	0.23	35	0.05					SDA 4...
SDQ 440 092 R ...	■	■	□	0.92	3	4	0.83	0.46	0.31	0.23	40	0.05					SDA 4...
SDQ 448 092 R ...	■	■	□	0.92	5	4	0.83	0.46	0.31	0.23	48	0.05					SDA 4...
SDQ 435 142 R ...	■	■	□	1.42	4.5	4	1.28	0.71	0.47	0.36	35	0.075					SDA 4...
SDQ 440 142 R ...	■	■	□	1.42	4.5	4	1.28	0.71	0.47	0.36	40	0.075					SDA 4...
SDQ 448 142 R ...	■	■	□	1.42	7.5	4	1.28	0.71	0.47	0.36	48	0.075					SDA 4...
SDQ 435 192 R ...	■	■	□	1.92	6	4	1.73	0.96	0.64	0.47	35	0.1					SDA 4...
SDQ 440 192 R ...	■	■	□	1.92	6	4	1.73	0.96	0.64	0.47	40	0.1					SDA 4...
SDQ 448 192 R ...	■	■	□	1.92	10	4	1.73	0.96	0.64	0.47	48	0.1					SDA 4...
SDQ 435 242 R ...	■	■	□	2.42	7.5	4	2.18	1.21	0.81	0.61	35	0.125					SDA 4...
SDQ 440 242 R ...	■	■	□	2.42	7.5	4	2.18	1.21	0.81	0.61	40	0.125					SDA 4...
SDQ 448 242 R ...	■	■	□	2.42	12.5	4	2.18	1.21	0.81	0.61	48	0.125					SDA 4...
SDQ 440 292 R ...	■	■	□	2.92	9	4	2.63	1.46	0.97	0.73	40	0.15					SDA 4...
SDQ 448 292 R ...	■	■	□	2.92	15	4	2.63	1.46	0.97	0.73	48	0.15					SDA 4...
SDQ 440 342 R ...	■	■	□	3.42	10.5	4	3.08	1.71	1.14	0.86	40	0.175					SDA 4...
SDQ 448 342 R ...	■	■	□	3.42	17.5	4	3.08	1.71	1.14	0.86	48	0.175					SDA 4...
SDQ 440 392 R ...	■	■	□	3.92	12	4	3.53	1.96	1.31	0.98	40	0.2					SDA 4...
SDQ 448 392 R ...	■	■	□	3.92	20	4	3.53	1.96	1.31	0.98	48	0.2					SDA 4...
SDQ 644 442 R ...	■	■	□	4.42	9	6	3.98	2.21	1.47	1.11	44	0.225					SDA 6...
SDQ 656 442 R ...	■	■	□	4.42	18	6	3.98	2.21	1.47	1.11	56	0.225					SDA 6...
SDQ 668 442 R ...	■	■	□	4.42	27	6	3.98	2.21	1.47	1.11	68	0.225					SDA 6...
SDQ 644 492 R ...	■	■	□	4.92	10	6	4.43	2.46	1.64	1.23	44	0.25					SDA 6...
SDQ 656 492 R ...	■	■	□	4.92	20	6	4.43	2.46	1.64	1.23	56	0.25					SDA 6...
SDQ 668 492 R ...	■	■	□	4.92	30	6	4.43	2.46	1.64	1.23	68	0.25					SDA 6...
SDQ 644 542 R ...	■	■	□	5.42	11	6	4.88	2.71	1.8	1.36	44	0.275					SDA 6...
SDQ 656 542 R ...	■	■	□	5.42	22	6	4.88	2.71	1.8	1.36	56	0.275					SDA 6...
SDQ 668 542 R ...	■	■	□	5.42	33	6	4.88	2.71	1.8	1.36	68	0.275					SDA 6...
SDQ 644 592 R ...	■	■	□	5.92	12	6	5.33	2.96	1.97	1.48	44	0.3					SDA 6...
SDQ 656 592 R ...	■	■	□	5.92	24	6	5.33	2.96	1.97	1.48	56	0.3					SDA 6...
SDQ 668 592 R ...	■	■	□	5.92	36	6	5.33	2.96	1.97	1.48	68	0.3					SDA 6...
SDQ 850 692 R ...	■	■	□	6.92	14	8	6.23	3.46	2.3	1.73	50	0.35					SDA 8...
SDQ 866 692 R ...	■	■	□	6.92	28	8	6.23	3.46	2.3	1.73	66	0.35					SDA 8...
SDQ 882 692 R ...	■	■	□	6.92	42	8	6.23	3.46	2.3	1.73	82	0.35					SDA 8...
SDQ 850 792 R ...	■	■	□	7.92	16	8	7.13	3.96	2.64	1.98	50	0.4					SDA 8...
SDQ 866 792 R ...	■	■	□	7.92	32	8	7.13	3.96	2.64	1.98	66	0.4					SDA 8...
SDQ 882 792 R ...	■	■	□	7.92	48	8	7.13	3.96	2.64	1.98	82	0.4					SDA 8...

* Left execution and other coatings on demand

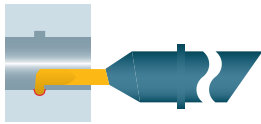

Radius-grooving

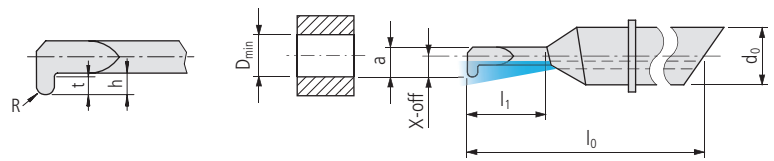

SDR ...

Order designation	Carbide			□ 20	Dimensions												Holder
	○	●	●		D _{min}	l ₁	d ₀	a	X-off	h	t	l ₀	R				□ 360...
R *	○	●	●														
	○	●	●														
	○	●	●														
	●	○	-														
	-	-	○														
				○													
					UHM 20												
					UHM 20 HX												
					UHM 20 TX+												

PREMIUM-LINE

SDR 435 092 R ...	■	■	□	0.92	3	4	0.83	0.46	0.3	0.2	35	0.1					SDA 4...
SDR 440 092 R ...	■	■	□	0.92	5	4	0.83	0.46	0.3	0.2	40	0.1					SDA 4...
SDR 435 142 R ...	■	■	□	1.42	4.5	4	1.28	0.71	0.38	0.25	35	0.125					SDA 4...
SDR 440 142 R ...	■	■	□	1.42	7.5	4	1.28	0.71	0.38	0.25	40	0.125					SDA 4...
SDR 435 192 R ...	■	■	□	1.92	6	4	1.73	0.96	0.45	0.3	35	0.15					SDA 4...
SDR 440 192 R ...	■	■	□	1.92	10	4	1.73	0.96	0.45	0.3	40	0.15					SDA 4...
SDR 435 242 R ...	■	■	□	2.42	7.5	4	2.18	1.21	0.53	0.35	35	0.175					SDA 4...
SDR 440 242 R ...	■	■	□	2.42	12.5	4	2.18	1.21	0.53	0.35	40	0.175					SDA 4...
SDR 440 292 R ...	■	■	□	2.92	9	4	2.63	1.46	0.6	0.4	40	0.2					SDA 4...
SDR 448 292 R ...	■	■	□	2.92	15	4	2.63	1.46	0.6	0.4	48	0.2					SDA 4...
SDR 440 342 R ...	■	■	□	3.42	10.5	4	3.08	1.71	0.68	0.45	40	0.225					SDA 4...
SDR 448 342 R ...	■	■	□	3.42	17.5	4	3.08	1.71	0.68	0.45	48	0.225					SDA 4...
SDR 440 392 R ...	■	■	□	3.92	12	4	3.53	1.96	0.75	0.5	40	0.25					SDA 4...
SDR 448 392 R ...	■	■	□	3.92	20	4	3.53	1.96	0.75	0.5	48	0.25					SDA 4...
SDR 644 442 R ...	■	■	□	4.42	9	6	3.98	2.21	0.98	0.65	44	0.275					SDA 6...
SDR 656 442 R ...	■	■	□	4.42	18	6	3.98	2.21	0.98	0.65	56	0.275					SDA 6...
SDR 668 442 R ...	■	■	□	4.42	27	6	3.98	2.21	0.98	0.65	68	0.275					SDA 6...
SDR 644 492 R ...	■	■	□	4.92	10	6	4.43	2.46	1.05	0.7	44	0.3					SDA 6...
SDR 656 492 R ...	■	■	□	4.92	20	6	4.43	2.46	1.05	0.7	56	0.3					SDA 6...
SDR 668 492 R ...	■	■	□	4.92	30	6	4.43	2.46	1.05	0.7	68	0.3					SDA 6...
SDR 644 542 R ...	■	■	□	5.42	11	6	4.88	2.71	1.13	0.75	44	0.325					SDA 6...
SDR 656 542 R ...	■	■	□	5.42	22	6	4.88	2.71	1.13	0.75	56	0.325					SDA 6...
SDR 668 542 R ...	■	■	□	5.42	33	6	4.88	2.71	1.13	0.75	68	0.325					SDA 6...
SDR 644 592 R ...	■	■	□	5.92	12	6	5.33	2.96	1.2	0.8	44	0.35					SDA 6...
SDR 656 592 R ...	■	■	□	5.92	24	6	5.33	2.96	1.2	0.8	56	0.35					SDA 6...
SDR 668 592 R ...	■	■	□	5.92	36	6	5.33	2.96	1.2	0.8	68	0.35					SDA 6...

* Left execution and other coatings on demand

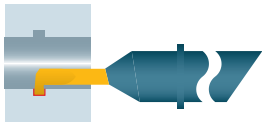

Grooving



SDS ...

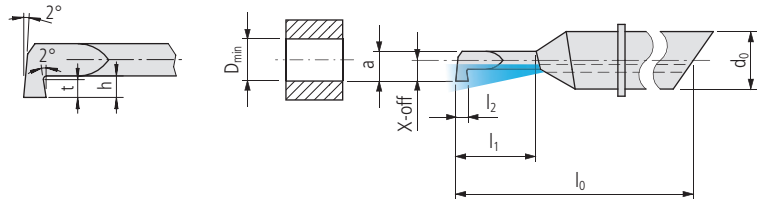

Order designation	Carbide			Dimensions										Holder					
	UHM 20	UHM 20 HX	UHM 20 TX+	D _{min}	l ₁	d ₀	a	X-off	h	t	l ₀	l ₂						360...	
R	○	●	●																
	○	●	●																
	○	●	●																
	○	●	●																
	○	●	●																
	○	●	●																
	○	●	●																
	○	●	●																
	○	●	●																
	○	●	●																
	○	●	●																

PREMIUM-LINE

SDS 435 092 R ...	■	■	■	0.92	3	4	0.83	0.46	0.31	0.23	35	0.2							SDA 4...
SDS 440 092 R ...	■	■	■	0.92	3	4	0.83	0.46	0.31	0.23	40	0.2							SDA 4...
SDS 448 092 R ...	■	■	■	0.92	5	4	0.83	0.46	0.31	0.23	48	0.2							SDA 4...
SDS 435 142 R ...	■	■	■	1.42	4.5	4	1.28	0.71	0.47	0.36	35	0.25							SDA 4...
SDS 440 142 R ...	■	■	■	1.42	4.5	4	1.28	0.71	0.47	0.36	40	0.25							SDA 4...
SDS 448 142 R ...	■	■	■	1.42	7.5	4	1.28	0.71	0.47	0.36	48	0.25							SDA 4...
SDS 435 192 R ...	■	■	■	1.92	6	4	1.73	0.96	0.64	0.48	35	0.3							SDA 4...
SDS 440 192 R ...	■	■	■	1.92	6	4	1.73	0.96	0.64	0.48	40	0.3							SDA 4...
SDS 448 192 R ...	■	■	■	1.92	10	4	1.73	0.96	0.64	0.48	48	0.3							SDA 4...
SDS 435 242 R ...	■	■	■	2.42	7.5	4	2.18	1.21	0.81	0.61	35	0.35							SDA 4...
SDS 440 242 R ...	■	■	■	2.42	7.5	4	2.18	1.21	0.81	0.61	40	0.35							SDA 4...
SDS 448 242 R ...	■	■	■	2.42	12.5	4	2.18	1.21	0.81	0.61	48	0.35							SDA 4...
SDS 440 292 R ...	■	■	■	2.92	9	4	2.63	1.46	0.97	0.73	40	0.4							SDA 4...
SDS 448 292 R ...	■	■	■	2.92	15	4	2.63	1.46	0.97	0.73	48	0.4							SDA 4...
SDS 440 342 R ...	■	■	■	3.42	10.5	4	3.08	1.71	1.14	0.86	40	0.45							SDA 4...
SDS 448 342 R ...	■	■	■	3.42	17.5	4	3.08	1.71	1.14	0.86	48	0.45							SDA 4...
SDS 440 392 R ...	■	■	■	3.92	12	4	3.53	1.96	1.31	0.98	40	0.5							SDA 4...
SDS 448 392 R ...	■	■	■	3.92	20	4	3.53	1.96	1.31	0.98	48	0.5							SDA 4...
SDS 644 442 R ...	■	■	■	4.42	9	6	3.98	2.21	1.47	1.11	44	1							SDA 6...
SDS 656 442 R ...	■	■	■	4.42	18	6	3.98	2.21	1.47	1.11	56	1							SDA 6...
SDS 668 442 R ...	■	■	■	4.42	27	6	3.98	2.21	1.47	1.11	68	1							SDA 6...
SDS 644 492 R ...	■	■	■	4.92	10	6	4.43	2.46	1.64	1.23	44	1.5							SDA 6...
SDS 656 492 R ...	■	■	■	4.92	20	6	4.43	2.46	1.64	1.23	56	1.5							SDA 6...
SDS 668 492 R ...	■	■	■	4.92	30	6	4.43	2.46	1.64	1.23	68	1.5							SDA 6...
SDS 644 542 R ...	■	■	■	5.42	11	6	4.88	2.71	1.8	1.36	44	1							SDA 6...
SDS 656 542 R ...	■	■	■	5.42	22	6	4.88	2.71	1.8	1.36	56	1							SDA 6...
SDS 668 542 R ...	■	■	■	5.42	33	6	4.88	2.71	1.8	1.36	68	1							SDA 6...
SDS 644 592 R ...	■	■	■	5.92	12	6	5.33	2.96	1.97	1.48	44	1.5							SDA 6...
SDS 656 592 R ...	■	■	■	5.92	24	6	5.33	2.96	1.97	1.48	56	1.5							SDA 6...
SDS 668 592 R ...	■	■	■	5.92	36	6	5.33	2.96	1.97	1.48	68	1.5							SDA 6...
SDS 850 692 R ...	■	■	■	6.92	14	8	6.23	3.46	2.3	1.73	50	1.5							SDA 8...
SDS 866 692 R ...	■	■	■	6.92	28	8	6.23	3.46	2.3	1.73	66	1.5							SDA 8...
SDS 882 692 R ...	■	■	■	6.92	42	8	6.23	3.46	2.3	1.73	82	1.5							SDA 8...
SDS 850 792 R ...	■	■	■	7.92	16	8	7.13	3.96	2.64	1.98	50	2							SDA 8...
SDS 866 792 R ...	■	■	■	7.92	32	8	7.13	3.96	2.64	1.98	66	2							SDA 8...
SDS 882 792 R ...	■	■	■	7.92	48	8	7.13	3.96	2.64	1.98	82	2							SDA 8...

* Left execution and other coatings on demand

352
UTILIS
multidec[®]
swiss type tools

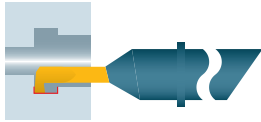

Grooving and turning

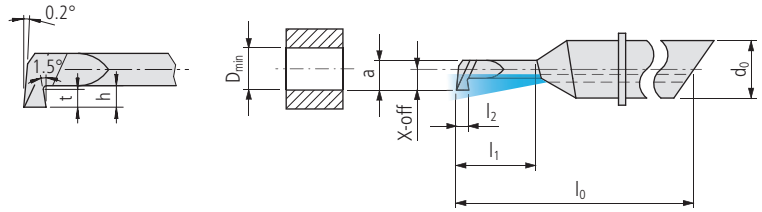

SDT ...

Order designation	Carbide □ 20			Dimensions											Holder			
	UHM 20	UHM 20 HX	UHM 20 TX+	D _{min}	l ₁	d ₀	a	X-off	h	t	l ₀	l ₂					□ 360...	
R *	○	●	●															
	○	●	●															
	○	●	●															
	●	○	-															
	-	-	○															

PREMIUM-LINE

SDT 440 392 R ...	■	■	□	3.92	12	4	3.53	1.96	1.31	1	40	1						SDA 4...
SDT 448 392 R ...	■	■	□	3.92	20	4	3.53	1.96	1.31	1	48	1						SDA 4...
SDT 644 592 R ...	■	■	□	5.92	12	6	5.33	2.96	1.97	1.5	44	1.25						SDA 6...
SDT 656 592 R ...	■	■	□	5.92	24	6	5.33	2.96	1.97	1.5	56	1.25						SDA 6...
SDT 668 592 R ...	■	■	□	5.92	36	6	5.33	2.96	1.97	1.5	68	1.25						SDA 6...
SDT 850 792 R ...	■	■	□	7.92	16	8	7.13	3.96	2.64	2	50	1.5						SDA 8...
SDT 866 792 R ...	■	■	□	7.92	32	8	7.13	3.96	2.64	2	66	1.5						SDA 8...
SDT 882 792 R ...	■	■	□	7.92	48	8	7.13	3.96	2.64	2	82	1.5						SDA 8...

* Left execution and other coatings on demand

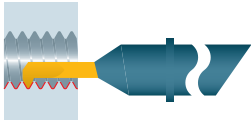

Threading (partial profile 60°)

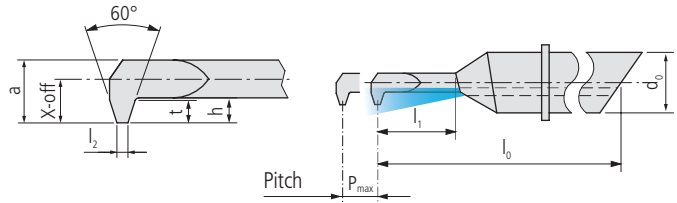

SDU ...

Order designation	Carbide □ 20			Standard	Dimensions								Holder □ 360...
	UHM 20	UHM 20 HX	UHM 20 TX+		P _{max}	l ₁	d ₀	a	X-off	h	t	l ₀	
R *	○	○	○	ISO DIN13									
	○	○	○										
	○	○	○										

PREMIUM-LINE

SDU 435 160 R ...	■	■	□	M2	0.4	3	4	1.1	0.8	0.5	0.35	35	0.02	SDA 4...
SDU 440 160 R ...	■	■	□	M2	0.4	4.8	4	1.1	0.8	0.5	0.35	40	0.02	SDA 4...
SDU 435 200 R ...	■	■	□	M3	0.5	4.5	4	1.3	1	0.6	0.45	35	0.03	SDA 4...
SDU 440 200 R ...	■	■	□	M3	0.5	6	4	1.3	1	0.6	0.45	40	0.03	SDA 4...
SDU 435 300 R ...	■	■	□	M4	0.7	6	4	2	1.5	0.9	0.6	35	0.04	SDA 4...
SDU 440 300 R ...	■	■	□	M4	0.7	9	4	2	1.5	0.9	0.6	40	0.04	SDA 4...
SDU 435 400 R ...	■	■	□	M5	0.8	7.5	4	2.7	2	1.2	0.8	35	0.05	SDA 4...
SDU 440 400 R ...	■	■	□	M5	0.8	12	4	2.7	2	1.2	0.8	40	0.05	SDA 4...
SDU 656 500 R ...	■	■	□	M6/7	1	15	6	3.8	2.05	1.2	0.9	56	0.06	SDA 6...
SDU 656 600 R ...	■	■	□	M6/7	1	18	6	4.6	2.45	1.2	0.9	56	0.07	SDA 6...
SDU 656 700 R ...	■	■	□	M8/9	1.25	21	6	5.6	2.95	1.4	1.1	56	0.08	SDA 6...

* Left execution and other coatings on demand

Recommendations for thread cutting □ 170

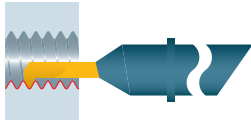

Threading (full profile metric)



SDV ...

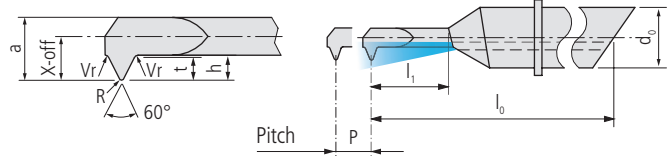

Order designation	Carbide			Standard	Dimensions										Holder		
	UHM 20	UHM 20 HX	UHM 20 TX+		P	l ₁	d ₀	a	X-off	h	t	l ₀	R	Vr			
R *	<input type="checkbox"/>	<input type="checkbox"/>	<input type="checkbox"/>	ISO DIN13													360...

PREMIUM-LINE

Accuracy class of UTILIS

SDV 435 100 R ...	■	■	□	M1	0.25	3	4	0.56	0.5	0.25	0.15	35	0.02	0.04		SDA 4...
SDV 440 100 R ...	■	■	□	M1	0.25	5	4	0.56	0.5	0.25	0.15	40	0.02	0.04		SDA 4...
SDV 435 120 R ...	■	■	□	M1.2	0.25	3.6	4	0.75	0.6	0.25	0.15	35	0.02	0.04		SDA 4...
SDV 440 120 R ...	■	■	□	M1.2	0.25	6	4	0.75	0.6	0.25	0.15	40	0.02	0.04		SDA 4...
SDV 435 140 R ...	■	■	□	M1.4	0.3	4.2	4	0.88	0.7	0.29	0.18	35	0.02	0.05		SDA 4...
SDV 440 140 R ...	■	■	□	M1.4	0.3	7	4	0.88	0.7	0.29	0.18	40	0.02	0.05		SDA 4...
SDV 435 160 R ...	■	■	□	M1.6	0.35	4.8	4	1.01	0.8	0.32	0.21	35	0.02	0.05		SDA 4...
SDV 440 160 R ...	■	■	□	M1.6	0.35	8	4	1.01	0.8	0.32	0.21	40	0.02	0.05		SDA 4...
SDV 435 180 R ...	■	■	□	M1.8	0.35	5.4	4	1.2	0.9	0.32	0.21	35	0.02	0.05		SDA 4...
SDV 440 180 R ...	■	■	□	M1.8	0.35	9	4	1.2	0.9	0.32	0.21	40	0.02	0.05		SDA 4...
SDV 435 200 R ...	■	■	□	M2	0.4	6	4	1.33	1	0.36	0.23	35	0.02	0.05		SDA 4...
SDV 440 200 R ...	■	■	□	M2	0.4	10	4	1.33	1	0.36	0.23	40	0.02	0.05		SDA 4...
SDV 435 220 R ...	■	■	□	M2.2	0.45	6.6	4	1.46	1.1	0.4	0.26	35	0.02	0.05		SDA 4...
SDV 440 220 R ...	■	■	□	M2.2	0.45	11	4	1.46	1.1	0.4	0.26	40	0.02	0.05		SDA 4...
SDV 435 250 R ...	■	■	□	M2.5	0.45	7.5	4	1.74	1.25	0.4	0.26	35	0.02	0.05		SDA 4...
SDV 440 250 R ...	■	■	□	M2.5	0.45	12.5	4	1.74	1.25	0.4	0.26	40	0.02	0.05		SDA 4...
SDV 440 300 R ...	■	■	□	M3	0.5	9	4	2.16	1.5	0.43	0.29	40	0.02	0.05		SDA 4...
SDV 448 300 R ...	■	■	□	M3	0.5	15	4	2.16	1.5	0.43	0.29	48	0.02	0.05		SDA 4...
SDV 440 350 R ...	■	■	□	M3.5	0.6	10.5	4	2.51	1.75	0.51	0.35	40	0.03	0.05		SDA 4...
SDV 448 350 R ...	■	■	□	M3.5	0.6	17.5	4	2.51	1.75	0.51	0.35	48	0.03	0.05		SDA 4...
SDV 440 400 R ...	■	■	□	M4	0.7	12	4	2.86	2	0.58	0.41	40	0.03	0.05		SDA 4...
SDV 448 400 R ...	■	■	□	M4	0.7	20	4	2.86	2	0.58	0.41	48	0.03	0.05		SDA 4...
SDV 644 500 R ...	■	■	□	M5	0.8	10	6	3.69	2.48	0.63	0.47	44	0.04	0.05		SDA 6...
SDV 656 500 R ...	■	■	□	M5	0.8	20	6	3.69	2.48	0.63	0.47	56	0.04	0.05		SDA 6...
SDV 668 500 R ...	■	■	□	M5	0.8	30	6	3.69	2.48	0.63	0.47	68	0.04	0.05		SDA 6...
SDV 644 600 R ...	■	■	□	M6/7	1	12	6	4.39	2.98	0.8	0.59	44	0.05	0.05		SDA 6...
SDV 656 600 R ...	■	■	□	M6/7	1	24	6	4.39	2.98	0.8	0.59	56	0.05	0.05		SDA 6...
SDV 668 600 R ...	■	■	□	M6/7	1	36	6	4.39	2.98	0.8	0.59	68	0.05	0.05		SDA 6...
SDV 644 800 R ...	■	■	□	M8	1.25	12	6	5.99	2.98	0.98	0.73	44	0.06	0.05		SDA 6...
SDV 656 800 R ...	■	■	□	M8	1.25	24	6	5.99	2.98	0.98	0.73	56	0.06	0.05		SDA 6...
SDV 668 800 R ...	■	■	□	M8	1.25	36	6	5.99	2.98	0.98	0.73	68	0.06	0.05		SDA 6...

* Left execution and other coatings on demand

Recommendations for thread cutting 170

Legend 8...



Chamfering

356

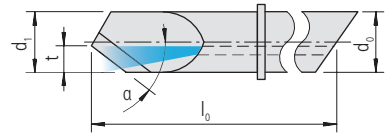

SDY ...

Order designation	Carbide □ 20			Dimensions										Holder			
		○	●	●	d ₀	d ₁	t	l ₀	α								
	○	●	●														
	○	●	●														
	●	○	-														
	-	-	○														
R *	UHM 20	UHM 20 HX	UHM 20 TX+														

PREMIUM-LINE

SDY 440 400-30 R ...	■	■	□	4	3.5	1.35	40	30°										SDA 4...
SDY 440 400-45 R ...	■	■	□	4	3.5	1.35	40	45°										SDA 4...
SDY 440 400-60 R ...	■	■	□	4	3.5	1.35	40	60°										SDA 4...
SDY 644 600-30 R ...	■	■	□	6	5.5	2.35	44	30°										SDA 6...
SDY 644 600-45 R ...	■	■	□	6	5.5	2.35	44	45°										SDA 6...
SDY 644 600-60 R ...	■	■	□	6	5.5	2.35	44	60°										SDA 6...

* Left execution and other coatings on demand

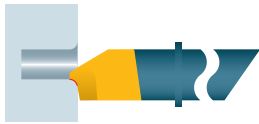

Radius

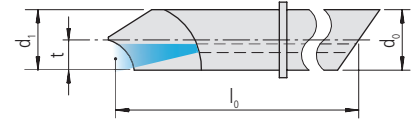
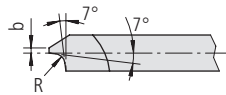

SDZ ...

Order designation	Carbide			Dimensions							Holder						
	<input type="checkbox"/> 20	<input type="checkbox"/> 20	<input type="checkbox"/> 20	d ₀	d ₁	b	t	l ₀	R								Holder
R *	<input type="checkbox"/>	<input type="checkbox"/>	<input type="checkbox"/>														<input type="checkbox"/> 360...
	<input type="checkbox"/>	<input type="checkbox"/>	<input type="checkbox"/>														
	<input type="checkbox"/>	<input type="checkbox"/>	<input type="checkbox"/>														
	<input type="checkbox"/>	<input type="checkbox"/>	<input type="checkbox"/>														
	<input type="checkbox"/>	<input type="checkbox"/>	<input type="checkbox"/>														
	<input type="checkbox"/>	<input type="checkbox"/>	<input type="checkbox"/>														
	<input type="checkbox"/>	<input type="checkbox"/>	<input type="checkbox"/>														
	<input type="checkbox"/>	<input type="checkbox"/>	<input type="checkbox"/>														

PREMIUM-LINE

SDZ 440 400-03 R ...	<input checked="" type="checkbox"/>	<input checked="" type="checkbox"/>	<input checked="" type="checkbox"/>	4	3.5	0.4	1.75	40	0.3									SDA 4...
SDZ 440 400-05 R ...	<input checked="" type="checkbox"/>	<input checked="" type="checkbox"/>	<input checked="" type="checkbox"/>	4	3.5	0.4	1.75	40	0.5									SDA 4...
SDZ 440 400-10 R ...	<input checked="" type="checkbox"/>	<input checked="" type="checkbox"/>	<input checked="" type="checkbox"/>	4	3.5	0.4	1.75	40	1									SDA 4...
SDZ 644 600-05 R ...	<input checked="" type="checkbox"/>	<input checked="" type="checkbox"/>	<input checked="" type="checkbox"/>	6	5.5	0.6	2.75	44	0.5									SDA 6...
SDZ 644 600-10 R ...	<input checked="" type="checkbox"/>	<input checked="" type="checkbox"/>	<input checked="" type="checkbox"/>	6	5.5	0.6	2.75	44	1.									SDA 6...
SDZ 644 600-15 R ...	<input checked="" type="checkbox"/>	<input checked="" type="checkbox"/>	<input checked="" type="checkbox"/>	6	5.5	0.6	2.75	44	1.5									SDA 6...

* Left execution and other coatings on demand

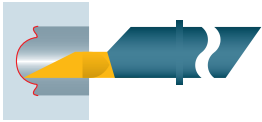

Copy turning (axial)



SXJ ...

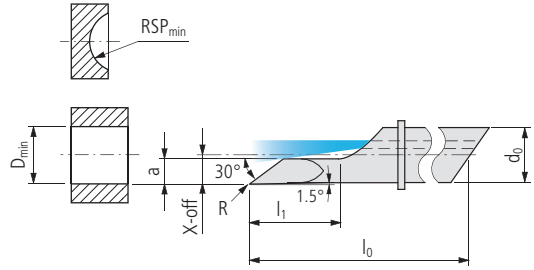

358
UTILIS
multidec[®]
swiss type tools

Order designation	Carbide □ 20			Dimensions										Holder				
	UHM 20	UHM 20 HX	UHM 20 TX+	D _{min}	l ₁	d ₀	a	X-off	RSP _{min}	R	l ₀							□ 360...
R *	○	○	○															

PREMIUM-LINE

SXJ 435 042 R ...	■	■	□	0.42	1.5	4	0.19	0.13	0.45	0.08	35							SDA 4...
SXJ 435 092 R ...	■	■	□	0.92	3	4	0.41	0.38	0.95	0.08	35							SDA 4...
SXJ 440 092 R ...	■	■	□	0.92	5	4	0.41	0.38	0.95	0.08	40							SDA 4...
SXJ 435 142 R ...	■	■	□	1.42	4.5	4	0.64	0.63	1.45	0.08	35							SDA 4...
SXJ 440 142 R ...	■	■	□	1.42	7.5	4	0.64	0.63	1.45	0.08	40							SDA 4...
SXJ 435 192 R ...	■	■	□	1.92	6	4	0.86	0.88	1.95	0.08	35							SDA 4...
SXJ 440 192 R ...	■	■	□	1.92	10	4	0.86	0.88	1.95	0.08	40							SDA 4...
SXJ 435 242 R ...	■	■	□	2.42	7.5	4	1.09	1.13	2.45	0.08	35							SDA 4...
SXJ 440 242 R ...	■	■	□	2.42	12.5	4	1.09	1.13	2.45	0.08	40							SDA 4...
SXJ 440 292 R ...	■	■	□	2.92	9	4	1.31	1.38	2.95	0.08	40							SDA 4...
SXJ 448 292 R ...	■	■	□	2.92	15	4	1.31	1.38	2.95	0.08	48							SDA 4...
SXJ 440 342 R ...	■	■	□	3.42	10.5	4	1.54	1.63	3.45	0.08	40							SDA 4...
SXJ 448 342 R ...	■	■	□	3.42	17.5	4	1.54	1.63	3.45	0.08	48							SDA 4...
SXJ 440 392 R ...	■	■	□	3.92	12	4	1.76	1.88	3.95	0.08	40							SDA 4...
SXJ 448 392 R ...	■	■	□	3.92	20	4	1.76	1.88	3.95	0.08	48							SDA 4...
SXJ 644 442 R ...	■	■	□	4.42	9	6	1.99	2.09	4.45	0.12	44							SDA 6...
SXJ 656 442 R ...	■	■	□	4.42	18	6	1.99	2.09	4.45	0.12	56							SDA 6...
SXJ 668 442 R ...	■	■	□	4.42	27	6	1.99	2.09	4.45	0.12	68							SDA 6...
SXJ 644 492 R ...	■	■	□	4.92	10	6	2.21	2.34	4.95	0.12	44							SDA 6...
SXJ 656 492 R ...	■	■	□	4.92	20	6	2.21	2.34	4.95	0.12	56							SDA 6...
SXJ 668 492 R ...	■	■	□	4.92	30	6	2.21	2.34	4.95	0.12	68							SDA 6...
SXJ 644 542 R ...	■	■	□	5.42	11	6	2.44	2.59	5.45	0.12	44							SDA 6...
SXJ 656 542 R ...	■	■	□	5.42	22	6	2.44	2.59	5.45	0.12	56							SDA 6...
SXJ 668 542 R ...	■	■	□	5.42	33	6	2.44	2.59	5.45	0.12	68							SDA 6...
SXJ 644 592 R ...	■	■	□	5.92	12	6	2.66	2.84	5.95	0.12	44							SDA 6...
SXJ 656 592 R ...	■	■	□	5.92	24	6	2.66	2.84	5.95	0.12	56							SDA 6...
SXJ 668 592 R ...	■	■	□	5.92	36	6	2.66	2.84	5.95	0.12	68							SDA 6...
SXJ 850 692 R ...	■	■	□	6.92	14	8	3.11	3.3	6.95	0.16	50							SDA 8...
SXJ 866 692 R ...	■	■	□	6.92	28	8	3.11	3.3	6.95	0.16	66							SDA 8...
SXJ 882 692 R ...	■	■	□	6.92	42	8	3.11	3.3	6.95	0.16	82							SDA 8...
SXJ 850 792 R ...	■	■	□	7.92	16	8	3.56	3.8	7.95	0.16	50							SDA 8...
SXJ 866 792 R ...	■	■	□	7.92	32	8	3.56	3.8	7.95	0.16	66							SDA 8...
SXJ 882 792 R ...	■	■	□	7.92	48	8	3.56	3.8	7.95	0.16	82							SDA 8...

* Left execution and other coatings on demand

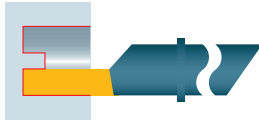

Grooving (axial)

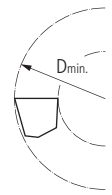

SXP ...

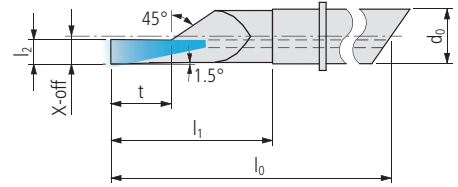

Order designation	Carbide			20	Dimensions										Holder			
	○	●	●		D _{min}	l ₁	d ₀	l ₂	X-off	t	l ₀							360...
R	○	●	●															
	○	●	●															
	○	●	●															
	○	●	●															
	○	●	●															
	○	●	●															
	○	●	●															
	○	●	●															
	○	●	●															
	○	●	●															
	○	●	●															
	○	●	●															
	○	●	●															
	○	●	●															
	○	●	●															
	○	●	●															
	○	●	●															
	○	●	●															
	○	●	●															
	○	●	●															
	○	●	●															
	○	●	●															
	○	●	●															
	○	●	●															
	○	●	●															
	○	●	●															
	○	●	●															
	○	●	●															

PREMIUM-LINE

SXP 435 142 R ...	■	■	□	1.42	4.5	4	0.35	0.71	0.8	35								SDA 4...
SXP 440 142 R ...	■	■	□	1.42	7.5	4	0.35	0.71	0.8	40								SDA 4...
SXP 435 192 R ...	■	■	□	1.92	6	4	0.35	0.96	0.8	35								SDA 4...
SXP 440 192 R ...	■	■	□	1.92	10	4	0.35	0.96	0.8	40								SDA 4...
SXP 435 242 R ...	■	■	□	2.42	7.5	4	0.35	1.21	0.8	35								SDA 4...
SXP 440 242 R ...	■	■	□	2.42	12.5	4	0.35	1.21	0.8	40								SDA 4...
SXP 440 292 R ...	■	■	□	2.92	9	4	0.35	1.46	0.8	40								SDA 4...
SXP 448 292 R ...	■	■	□	2.92	15	4	0.35	1.46	0.8	48								SDA 4...
SXP 440 342 R ...	■	■	□	3.42	10.5	4	0.35	1.71	0.8	40								SDA 4...
SXP 448 342 R ...	■	■	□	3.42	17.5	4	0.35	1.71	0.8	48								SDA 4...
SXP 440 392 R ...	■	■	□	3.92	12	4	0.35	1.96	0.8	40								SDA 4...
SXP 448 392 R ...	■	■	□	3.92	20	4	0.35	1.96	0.8	48								SDA 4...
SXP 644 442 R ...	■	■	□	4.42	9	6	0.5	2.21	1.2	44								SDA 6...
SXP 656 442 R ...	■	■	□	4.42	18	6	0.5	2.21	1.2	56								SDA 6...
SXP 668 442 R ...	■	■	□	4.42	27	6	0.5	2.21	1.2	68								SDA 6...
SXP 644 492 R ...	■	■	□	4.92	10	6	0.5	2.46	1.2	44								SDA 6...
SXP 656 492 R ...	■	■	□	4.92	20	6	0.5	2.46	1.2	56								SDA 6...
SXP 668 492 R ...	■	■	□	4.92	30	6	0.5	2.46	1.2	68								SDA 6...
SXP 644 542 R ...	■	■	□	5.42	11	6	0.5	2.71	1.2	44								SDA 6...
SXP 656 542 R ...	■	■	□	5.42	22	6	0.5	2.71	1.2	56								SDA 6...
SXP 668 542 R ...	■	■	□	5.42	33	6	0.5	2.71	1.2	68								SDA 6...
SXP 644 592 R ...	■	■	□	5.92	12	6	0.5	2.96	1.2	44								SDA 6...
SXP 656 592 R ...	■	■	□	5.92	24	6	0.5	2.96	1.2	56								SDA 6...
SXP 668 592 R ...	■	■	□	5.92	36	6	0.5	2.96	1.2	68								SDA 6...
SXP 850 692 R ...	■	■	□	6.92	14	8	0.75	3.46	1.6	50								SDA 8...
SXP 866 692 R ...	■	■	□	6.92	28	8	0.75	3.46	1.6	66								SDA 8...
SXP 882 692 R ...	■	■	□	6.92	42	8	0.75	3.46	1.6	82								SDA 8...
SXP 850 792 R ...	■	■	□	7.92	16	8	0.75	3.96	1.6	50								SDA 8...
SXP 866 792 R ...	■	■	□	7.92	32	8	0.75	3.96	1.6	66								SDA 8...
SXP 882 792 R ...	■	■	□	7.92	48	8	0.75	3.96	1.6	82								SDA 8...

* Left execution and other coatings on demand

Pay attention to the "working situations" for the correct selection of the combinations of tools and inserts 26...

Attention
The groove must not be made underneath the D_{min}-position.

Legend 8...

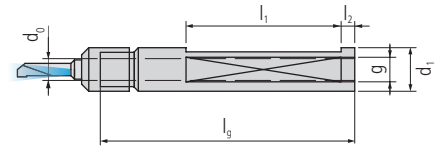

SDA ...

Order designation	Dimensions							Inserts
	d ₀	d ₁	l _g	l ₁	l ₂	g	□ 338...	

PREMIUM-LINE

SDA 4 060 07	■	4	7	60	—	—	M5					SD.4... / SX.4...
SDA 4 060 08	■	4	8	60	27	5	M5					SD.4... / SX.4...
SDA 4 100 08	■	4	8	100	59	5	R ¹ / ₈ "					SD.4... / SX.4...
SDA 4 060 10	■	4	10	60	27	5	M5					SD.4... / SX.4...
SDA 4 100 10	■	4	10	100	59	5	R ¹ / ₈ "					SD.4... / SX.4...
SDA 4 060 12	■	4	12	60	27	5	R ¹ / ₈ "					SD.4... / SX.4...
SDA 4 120 12	■	4	12	120	75	5	R ¹ / ₈ "					SD.4... / SX.4...
SDA 4 060 12.7	■	4	12.7	60	27	5	R ¹ / ₈ "					SD.4... / SX.4...
SDA 4 120 12.7	■	4	12.7	120	75	5	R ¹ / ₈ "					SD.4... / SX.4...
SDA 4 060 14	■	4	14	60	27	5	R ¹ / ₈ "					SD.4... / SX.4...
SDA 4 120 14	■	4	14	120	75	5	R ¹ / ₈ "					SD.4... / SX.4...
SDA 4 060 16	■	4	16	60	27	5	R ¹ / ₈ "					SD.4... / SX.4...
SDA 4 120 16	■	4	16	120	75	5	R ¹ / ₈ "					SD.4... / SX.4...
SDA 4 060 18	■	4	18	60	27	5	R ¹ / ₈ "					SD.4... / SX.4...
SDA 4 120 18	■	4	18	120	75	5	R ¹ / ₈ "					SD.4... / SX.4...
SDA 4 060 19.05	■	4	19.05	60	27	5	R ¹ / ₈ "					SD.4... / SX.4...
SDA 4 120 19.05	■	4	19.05	120	75	5	R ¹ / ₈ "					SD.4... / SX.4...
SDA 4 060 20	■	4	20	60	27	5	R ¹ / ₈ "					SD.4... / SX.4...
SDA 4 120 20	■	4	20	120	75	5	R ¹ / ₈ "					SD.4... / SX.4...
SDA 4 060 22	■	4	22	60	27	5	R ¹ / ₈ "					SD.4... / SX.4...
SDA 4 120 22	■	4	22	120	75	5	R ¹ / ₈ "					SD.4... / SX.4...
SDA 4 060 25	■	4	25	60	27	5	R ¹ / ₈ "					SD.4... / SX.4...
SDA 4 120 25	■	4	25	120	75	5	R ¹ / ₈ "					SD.4... / SX.4...
SDA 4 060 25.4	■	4	25.4	60	27	5	R ¹ / ₈ "					SD.4... / SX.4...
SDA 4 120 25.4	■	4	25.4	120	75	5	R ¹ / ₈ "					SD.4... / SX.4...
SDA 4 060 28	■	4	28	60	27	5	R ¹ / ₈ "					SD.4... / SX.4...
SDA 4 120 28	■	4	28	120	75	5	R ¹ / ₈ "					SD.4... / SX.4...
SDA 6 065 12	■	6	12	65	27	5	R ¹ / ₈ "					SD.6... / SX.6...
SDA 6 100 12	■	6	12	100	59	5	R ¹ / ₈ "					SD.6... / SX.6...
SDA 6 065 12.7	■	6	12.7	65	27	5	R ¹ / ₈ "					SD.6... / SX.6...
SDA 6 120 12.7	■	6	12.7	120	75	5	R ¹ / ₈ "					SD.6... / SX.6...
SDA 6 065 14	■	6	14	65	27	5	R ¹ / ₈ "					SD.6... / SX.6...
SDA 6 120 14	■	6	14	120	75	5	R ¹ / ₈ "					SD.6... / SX.6...
SDA 6 065 16	■	6	16	65	27	5	R ¹ / ₈ "					SD.6... / SX.6...
SDA 6 120 16	■	6	16	120	75	5	R ¹ / ₈ "					SD.6... / SX.6...
SDA 6 065 18	■	6	18	65	27	5	R ¹ / ₈ "					SD.6... / SX.6...
SDA 6 120 18	■	6	18	120	75	5	R ¹ / ₈ "					SD.6... / SX.6...
SDA 6 065 19.05	■	6	19.05	65	27	5	R ¹ / ₈ "					SD.6... / SX.6...
SDA 6 120 19.05	■	6	19.05	120	75	5	R ¹ / ₈ "					SD.6... / SX.6...
SDA 6 065 20	■	6	20	65	27	5	R ¹ / ₈ "					SD.6... / SX.6...
SDA 6 120 20	■	6	20	120	75	5	R ¹ / ₈ "					SD.6... / SX.6...
SDA 6 065 22	■	6	22	65	27	5	R ¹ / ₈ "					SD.6... / SX.6...

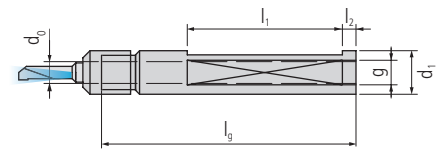

SDA ...

Order designation	Dimensions							Inserts	
	d ₀	d ₁	l _g	l ₁	l ₂	g	338...		
N									
PREMIUM-LINE									
SDA 6 120 22	■	6	22	120	75	5	R ^{1/8"}		SD.6... / SX.6...
SDA 6 065 25	■	6	25	65	27	5	R ^{1/8"}		SD.6... / SX.6...
SDA 6 120 25	■	6	25	120	75	5	R ^{1/8"}		SD.6... / SX.6...
SDA 6 065 25.4	■	6	25.4	65	27	5	R ^{1/8"}		SD.6... / SX.6...
SDA 6 120 25.4	■	6	25.4	120	75	5	R ^{1/8"}		SD.6... / SX.6...
SDA 6 065 28	■	6	28	65	27	5	R ^{1/8"}		SD.6... / SX.6...
SDA 6 120 28	■	6	28	120	75	5	R ^{1/8"}		SD.6... / SX.6...
SDA 8 070 14	■	8	14	70	27	5	R ^{1/8"}		SD.8... / SX.8...
SDA 8 100 14	■	8	14	100	59	5	R ^{1/8"}		SD.8... / SX.8...
SDA 8 070 16	■	8	16	70	27	5	R ^{1/8"}		SD.8... / SX.8...
SDA 8 120 16	■	8	16	120	75	5	R ^{1/8"}		SD.8... / SX.8...
SDA 8 120 18	■	8	18	120	75	5	R ^{1/8"}		SD.8... / SX.8...
SDA 8 070 19.05	■	8	19.05	70	27	5	R ^{1/8"}		SD.8... / SX.8...
SDA 8 120 19.05	■	8	19.05	120	75	5	R ^{1/8"}		SD.8... / SX.8...
SDA 8 070 20	■	8	20	70	27	5	R ^{1/8"}		SD.8... / SX.8...
SDA 8 120 20	■	8	20	120	75	5	R ^{1/8"}		SD.8... / SX.8...
SDA 8 070 22	■	8	22	70	27	5	R ^{1/8"}		SD.8... / SX.8...
SDA 8 120 22	■	8	22	120	75	5	R ^{1/8"}		SD.8... / SX.8...
SDA 8 070 25	■	8	25	70	27	5	R ^{1/8"}		SD.8... / SX.8...
SDA 8 120 25	■	8	25	120	75	5	R ^{1/8"}		SD.8... / SX.8...
SDA 8 070 25.4	■	8	25.4	70	27	5	R ^{1/8"}		SD.8... / SX.8...
SDA 8 120 25.4	■	8	25.4	120	75	5	R ^{1/8"}		SD.8... / SX.8...
SDA 8 070 28	■	8	28	70	27	5	R ^{1/8"}		SD.8... / SX.8...
SDA 8 120 28	■	8	28	120	75	5	R ^{1/8"}		SD.8... / SX.8...

Reduction sleeve 655

Legend 8...

362

UTILIS
multidec
swiss type tools

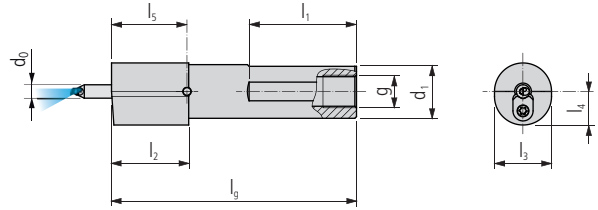

SDA ... SC

Order designation	Dimensions										Inserts □ 338...	
	d ₀	d ₁	l _g	l ₁	l ₂	l ₃	l ₄	l ₅	g			
N												
PREMIUM-LINE												
SDA 4 073 050 07 SC	■	4	7	73	32	23	9	10	22.5	M5		SD.4... / SX.4...
SDA 4 073 050 08 SC	■	4	8	73	32	23	9	10	22.5	M5		SD.4... / SX.4...
SDA 4 073 050 10 SC	■	4	10	73	32	23	11	10	22.5	M5		SD.4... / SX.4...
SDA 4 073 050 12 SC	■	4	12	73	32	23	13	10	22.5	G ¹ / ₈ "		SD.4... / SX.4...
SDA 4 073 050 12.7 SC	■	4	12.7	73	32	23	13	10	22.5	G ¹ / ₈ "		SD.4... / SX.4...
SDA 4 073 050 16 SC	■	4	16	73	32	23	17	10	22.5	G ¹ / ₈ "		SD.4... / SX.4...
SDA 4 073 050 19.05 SC	■	4	19.05	73	—	—	19.05	10	22.5	G ¹ / ₈ "		SD.4... / SX.4...
SDA 4 133 110 19.05 SC	■	4	19.05	133	—	—	19.05	10	22.5	G ¹ / ₈ "		SD.4... / SX.4...
SDA 4 073 000 20 SC	■	4	20	73	—	—	20	10	22.5	G ¹ / ₈ "		SD.4... / SX.4...
SDA 4 073 000 22 SC	■	4	22	73	—	—	22	11	22.5	G ¹ / ₈ "		SD.4... / SX.4...
SDA 4 133 000 25 SC	■	4	25	133	—	—	25	12.5	22.5	G ¹ / ₈ "		SD.4... / SX.4...
SDA 4 133 000 25.40 SC	■	4	25.4	133	—	—	25.4	12.7	22.5	G ¹ / ₈ "		SD.4... / SX.4...
SDA 4 073 000 28 SC	■	4	28	73	—	—	25	14	22.5	G ¹ / ₈ "		SD.4... / SX.4...
SDA 6 078 055 10 SC	■	6	10	78	32	23	13	11.2	26.2	M5		SD.6... / SX.6...
SDA 6 078 055 12 SC	■	6	12	78	32	23	13	11.2	26.2	G ¹ / ₈ "		SD.6... / SX.6...
SDA 6 078 055 12.7 SC	■	6	12.7	78	32	23	13	11.2	26.2	G ¹ / ₈ "		SD.6... / SX.6...
SDA 6 078 055 16 SC	■	6	16	78	32	23	17	11.2	26.2	G ¹ / ₈ "		SD.6... / SX.6...
SDA 6 078 055 19.05 SC	■	6	19.05	78	32	23	20	11.2	26.2	G ¹ / ₈ "		SD.6... / SX.6...
SDA 6 133 110 19.05 SC	■	6	19.05	133	64	23	20	11.2	26.2	G ¹ / ₈ "		SD.6... / SX.6...
SDA 6 078 055 20 SC	■	6	20	78	32	23	20	11.2	26.2	G ¹ / ₈ "		SD.6... / SX.6...
SDA 6 133 000 22 SC	■	6	22	133	—	—	22	11.5	26.2	G ¹ / ₈ "		SD.6... / SX.6...
SDA 6 078 000 28 SC	■	6	28	78	—	—	25	14	26.2	G ¹ / ₈ "		SD.6... / SX.6...
SDA 8 083 060 14 SC	■	8	14	83	32	23	17	12.3	27.9	G ¹ / ₈ "		SD.8... / SX.8...
SDA 8 083 060 16 SC	■	8	16	83	32	23	17	12.3	27.9	G ¹ / ₈ "		SD.8... / SX.8...
SDA 8 083 060 19.05 SC	■	8	19.05	83	32	23	20	12.3	27.9	G ¹ / ₈ "		SD.8... / SX.8...
SDA 8 083 060 20 SC	■	8	20	83	32	23	20	12.3	27.9	G ¹ / ₈ "		SD.8... / SX.8...
SDA 8 083 000 28 SC	■	8	28	83	—	—	25	14	27.9	G ¹ / ₈ "		SD.8... / SX.8...

Reduction sleeve □ 655

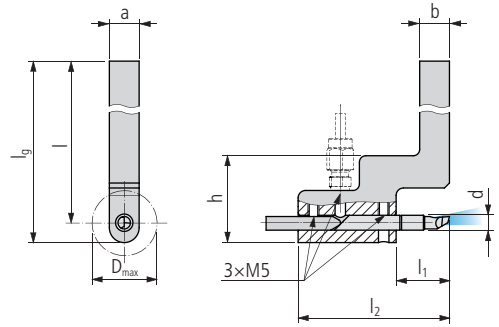

Legend □ 8...





AKR M...

Order designation	Dimensions											Inserts □ 338...	
	d	a	b	l	l _g	l ₁	l ₂	h	D _{max}				
R													
PREMIUM-LINE													
AKR M 0808x100 D4-3540	■	4	8	8	100	106.5	20	55	32.5	26			SD.4.../SX.4...
AKR M 0808x100 D4-48	■	4	8	8	100	106.5	30	65	32.5	26			SD.448.../SX.448...
AKR M 1010x100 D4-3540	■	4	10	10	100	106.5	20	55	32.5	26			SD.4.../SX.4...
AKR M 1010x100 D4-48	■	4	10	10	100	106.5	30	65	32.5	26			SD.448.../SX.448...
AKR M 1212x100 D4-3540	■	4	12	12	100	106.5	20	55	32.5	26			SD.4.../SX.4...
AKR M 1212x100 D4-48	■	4	12	12	100	106.5	30	65	32.5	26			SD.448.../SX.448...
AKR M 1/2"x100 D4-3540	■	4	12.7	12.7	100	106.85	20	55	32.85	26			SD.4.../SX.4...
AKR M 1/2"x100 D4-48	■	4	12.7	12.7	100	106.85	30	65	32.85	26			SD.448.../SX.448...
AKR M 1616x125 D4-3540	■	4	16	16	125	133	20	55	34	26			SD.4.../SX.4...
AKR M 1616x125 D4-48	■	4	16	16	125	133	30	65	34	26			SD.448.../SX.448...
AKR M 1010x100 D6-44	■	6	10	10	100	107.5	21.5	61	34.5	26			SD.644.../SX.644...
AKR M 1010x100 D6-56	■	6	10	10	100	107.5	33.5	73	34.5	26			SD.656.../SX.656...
AKR M 1010x100 D6-68	■	6	10	10	100	107.5	45.5	85	34.5	26			SD.668.../SX.668...
AKR M 1212x100 D6-44	■	6	12	12	100	108	21.5	61	35	26			SD.644.../SX.644...
AKR M 1212x100 D6-56	■	6	12	12	100	108	33.5	73	35	26			SD.656.../SX.656...
AKR M 1212x100 D6-68	■	6	12	12	100	108	45.5	85	35	26			SD.668.../SX.668...
AKR M 1/2"x100 D6-44	■	6	12.7	12.7	100	107.35	21.5	61	34.35	26			SD.644.../SX.644...
AKR M 1/2"x100 D6-56	■	6	12.7	12.7	100	107.35	33.5	73	34.35	26			SD.656.../SX.656...
AKR M 1/2"x100 D6-68	■	6	12.7	12.7	100	107.35	45.5	85	34.35	26			SD.668.../SX.668...
AKR M 1616x125 D6-44	■	6	16	16	125	133	21.5	61	35	26			SD.644.../SX.644...
AKR M 1616x125 D6-56	■	6	16	16	125	133	33.5	73	35	26			SD.656.../SX.656...
AKR M 1616x125 D6-68	■	6	16	16	125	133	45.5	85	35	26			SD.668.../SX.668...



For holders (SDA ...)

Illustration	Description	Dimensions	Order designation	Inserts	Holder
	Nut	M8×0.5	MSP SDA 4M	■	SDA 4...
		M12×0.6	MSP SDA 6M	■	SDA 6...
		M14×0.75	MSP SDA 8M	■	SDA 8...
	Aligning device		SDA 4X	■	SDA 4...
			SDA 6X	■	SDA 6...
			SDA 8X	■	SDA 8...
	Retaining ring		MSP SDA 4S	■	SD. 4...
			MSP SDA 6S	■	SD. 6...
			MSP SDA 8S	■	SD. 8...

For holders (SDA ...SC)

Illustration	Description	Dimensions	Order designation	Holder
	Grub screw	M4×15 L/R	MSP 40150 T08	■ SDA ...SC
	Thrust piece		MSP SDA DS	■ SDA ...SC
	Torx screwdriver	TX 08	MSP TX08 SDA SC	■ SDA ...SC

For holders (AKR M...)

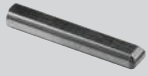
Illustration	Description	Dimensions	Order designation	Holder
	Clamping screw	M5×10	MSP 50100 IB2.5	■ AKR M...
	Allen key	SW 2.5	MSP IB2.5	■ AKR M...
	Stop-Pin	4×25	MSP 40250 AN D4	■ AKR M...D4
		6×30	MSP 60300 AN D6	■ AKR M...D6

364

UTILIS
multidec®
SWISS type tools

	Steel unalloyed			Steel low alloyed			Steel high alloyed		
Hardness value (HB)/(HRC)	125–300 HB			180–250 HB			200–350 HB		
Category	I			II			III		
Machining method	▼	▼▼	▼▼▼	▼	▼▼	▼▼▼	▼	▼▼	▼▼▼
Cutting speeds	v _c (m/min)								
Cutting material carbide									
UHM 20	–	–	20–120	–	–	20–100	–	–	20–90
UHM 20 HX	–	–	30–160	–	–	30–140	–	–	30–130
UHM 20 TX+	–	–	–	–	–	–	–	–	30–100

366

UTILIS
multidec[®]
swiss type tools

	Stainless steel			Stainless steel			Titanium		
Hardness value (HB)/(HRC)	180–220 HB			220–330 HB			–		
Category	V			VI			IV		
Machining method	▼	▼▼	▼▼▼	▼	▼▼	▼▼▼	▼	▼▼	▼▼▼
Cutting speeds	v _c (m/min)								
Cutting material carbide									
UHM 20	–	–	20–80	–	–	20–60	–	–	20–70
UHM 20 HX	–	–	30–120	–	–	30–100	–	–	30–100
UHM 20 TX+	–	–	30–100	–	–	30–80	–	–	30–80

	Aluminum			Brass			Hard materials		
Hardness value (HB)/(HRC)	60–130 HB			–			45–70 HRC		
Category	VII			VIII			X		
Machining method	▼	▼▼	▼▼▼	▼	▼▼	▼▼▼	▼	▼▼	▼▼▼
Cutting speeds	v _c (m/min)								
Cutting material carbide									
UHM 20	–	–	50–220	–	–	30–110	–	–	–
UHM 20 HX	–	–	60–350	–	–	50–180	–	–	–
UHM 20 TX+	–	–	–	–	–	–	–	–	15–40

Feed (f) and depths of cut (a_p) □ 367

SDG – SXG – SDH – SDI – SXI – SDY – SDZ

D (mm)	Steel unalloyed		Steel low alloyed		Steel high alloyed		Stainless steel		Titanium		Aluminum/Brass		Hard materials	
	f (mm)	a _p (mm)	f (mm)	a _p (mm)	f (mm)	a _p (mm)	f (mm)	a _p (mm)	f (mm)	a _p (mm)	f (mm)	a _p (mm)	f (mm)	a _p (mm)
≤1	0.01– 0.02	0.1– 0.2	0.01– 0.017	0.1– 0.17	0.007– 0.017	0.07– 0.17	0.007– 0.017	0.07– 0.17	0.006– 0.02	0.06– 0.2	0.01– 0.025	0.1– 0.25	0.006– 0.02	0.06– 0.2
2	0.012– 0.022	0.12– 0.22	0.012– 0.02	0.12– 0.2	0.008– 0.018	0.08– 0.18	0.008– 0.018	0.08– 0.18	0.008– 0.02	0.08– 0.2	0.015– 0.03	0.15– 0.3	0.008– 0.02	0.08– 0.2
3	0.015– 0.025	0.15– 0.25	0.014– 0.024	0.14– 0.24	0.009– 0.019	0.09– 0.19	0.009– 0.019	0.09– 0.19	0.01– 0.02	0.1– 0.2	0.015– 0.035	0.15– 0.35	0.01– 0.02	0.1– 0.2
4	0.015– 0.027	0.15– 0.27	0.015– 0.025	0.15– 0.25	0.01– 0.02	0.1– 0.2	0.01– 0.02	0.1– 0.2	0.01– 0.02	0.1– 0.2	0.015– 0.035	0.15– 0.35	0.01– 0.02	0.1– 0.2
6	0.015– 0.03	0.15– 0.3	0.015– 0.025	0.15– 0.25	0.01– 0.02	0.1– 0.2	0.01– 0.02	0.1– 0.2	0.01– 0.025	0.1– 0.25	0.015– 0.04	0.15– 0.4	0.01– 0.025	0.1– 0.25
8	0.015– 0.03	0.15– 0.3	0.015– 0.025	0.15– 0.25	0.01– 0.02	0.1– 0.2	0.01– 0.02	0.1– 0.2	0.01– 0.025	0.1– 0.25	0.015– 0.05	0.15– 0.5	0.01– 0.025	0.1– 0.25

SDK – SDM – SDO – SDQ – SDW – SDT – SXJ – SXP

D (mm)	Steel unalloyed		Steel low alloyed		Steel high alloyed		Stainless steel		Titanium		Aluminum/Brass		Hard materials	
	f (mm)	a _p (mm)	f (mm)	a _p (mm)	f (mm)	a _p (mm)	f (mm)	a _p (mm)	f (mm)	a _p (mm)	f (mm)	a _p (mm)	f (mm)	a _p (mm)
≤1	0.01– 0.02	0.1– 0.2	0.01– 0.017	0.1– 0.17	0.007– 0.015	0.07– 0.15	0.007– 0.015	0.07– 0.15	0.006– 0.012	0.06– 0.12	0.007– 0.012	0.07– 0.12	0.006– 0.012	0.06– 0.12
2	0.01– 0.022	0.1– 0.22	0.01– 0.02	0.1– 0.2	0.008– 0.017	0.08– 0.17	0.008– 0.017	0.08– 0.17	0.008– 0.015	0.08– 0.15	0.01– 0.015	0.1– 0.15	0.008– 0.015	0.08– 0.15
3	0.01– 0.025	0.1– 0.25	0.01– 0.022	0.1– 0.22	0.009– 0.02	0.09– 0.2	0.009– 0.02	0.09– 0.2	0.008– 0.017	0.08– 0.17	0.01– 0.02	0.1– 0.2	0.008– 0.017	0.08– 0.17
4	0.01– 0.025	0.1– 0.25	0.01– 0.025	0.1– 0.25	0.01– 0.022	0.1– 0.22	0.01– 0.022	0.1– 0.22	0.008– 0.02	0.08– 0.2	0.01– 0.025	0.1– 0.25	0.008– 0.02	0.08– 0.2
6	0.01– 0.025	0.1– 0.25	0.01– 0.025	0.1– 0.25	0.01– 0.025	0.1– 0.25	0.01– 0.025	0.1– 0.25	0.008– 0.02	0.08– 0.2	0.01– 0.03	0.1– 0.3	0.008– 0.02	0.08– 0.2
8	0.01– 0.025	0.1– 0.25	0.01– 0.025	0.1– 0.25	0.01– 0.025	0.1– 0.25	0.01– 0.025	0.1– 0.25	0.008– 0.02	0.08– 0.2	0.01– 0.035	0.1– 0.35	0.008– 0.02	0.08– 0.2

SDR – SDS

	Steel unalloyed	Steel low alloyed	Steel high alloyed	Stainless steel	Titanium	Aluminum/Brass	Hard materials
	f (mm)	f (mm)	f (mm)	f (mm)	f (mm)	f (mm)	f (mm)
	0.007–0.020	0.005–0.015	0.005–0.015	0.005–0.015	0.005–0.015	0.007–0.020	0.005–0.015

SDU – SDV (Threading)

Recommendations for thread cutting 170

Polygonal punching is a chip-removing procedure for manufacturing of inside profiles in holes which are usually not continuous. During this procedure, the tool is pushed into a hole in several so-called strokes, and the outline of the broaching tool is introduced into the workpiece.



We can supply square, hexagonal and TORX broaching tools made from carbide from our standard product range. We can also manufacture customised shapes and intermediate sizes on request.



Benefits:

- Short machining times
- Complex geometries with sharp edges are possible
- Full profile tools reduce the number of strokes
- Reliable process with long tool life

Overview – multidec®-BROACH

Technical information		11
Broaching tool		370
Process data		373
Special tools – multidec4you®		600
Accessories		651

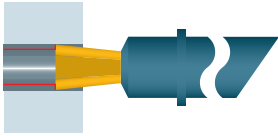

Polygonal punching square

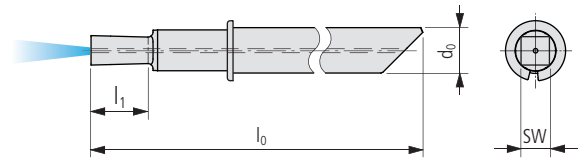

370

SD-BRS ...

Order designation	Carbide □ 20		Dimensions								Holder □ 360...
	○	●	SW	l ₁	d ₀	l ₀					
	○	●									
	○	●									
	○	●									
	●	-									
	-	○									
	UHM 20	UHM 20 TX+									

PREMIUM-LINE

SD-BRS 435 100 ...	■	□	1	2	4	35					SDA 4...
SD-BRS 435 150 ...	■	□	1.5	2	4	35					SDA 4...
SD-BRS 435 200 ...	■	□	2	3	4	35					SDA 4...
SD-BRS 644 300 ...	■	□	3	4	6	44					SDA 6...
SD-BRS 644 400 ...	■	□	4	6	6	44					SDA 6...
SD-BRS 850 500 ...	■	□	5	7	8	50					SDA 8...

UTILIS
multidec[®]
swiss type tools

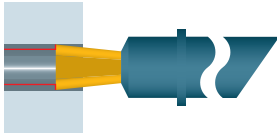

Polygonal punching hexagonal

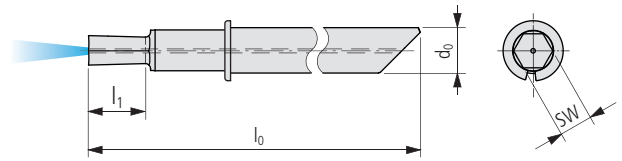

SD-BRH ...

Order designation	Carbide □ 20		Dimensions								Holder
	○	●	SW	l ₁	d ₀	l ₀					□ 360...
	○	●									
	○	●									
	○	●									
	●	-									
	-	○									
	UHM 20	UHM 20TX+									

PREMIUM-LINE

SD-BRH 435 100 ...	■	□	1	1.5	4	35					SDA 4...
SD-BRH 435 150 ...	■	□	1.5	2	4	35					SDA 4...
SD-BRH 435 200 ...	■	□	2	2.5	4	35					SDA 4...
SD-BRH 435 250 ...	■	□	2.5	4	4	35					SDA 4...
SD-BRH 435 300 ...	■	□	3	3.5	4	35					SDA 4...
SD-BRH 644 350 ...	■	□	3.5	6	6	35					SDA 6...
SD-BRH 644 400 ...	■	□	4	6	6	44					SDA 6...
SD-BRH 850 500 ...	■	□	5	7	8	50					SDA 8...
SD-BRH 850 600 ...	■	□	6	8	8	50					SDA 8...

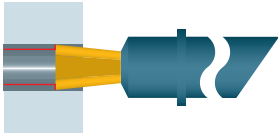

Polygonalpunching TORX

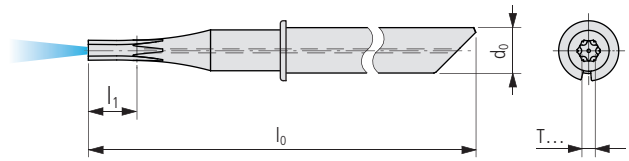

372

SD-BRT ...

Order designation	Carbide	□ 20	Standard	Dimensions							Holder
	○	●									□ 360...
	○	●									
	○	●									
	●	-									
	-	○									
	UHM 20	UHM 20 TX+	ISO 10664	l_1	d_0	l_0					

PREMIUM-LINE

SD-BRT 440 002 ...	■	□	T2	1.5	4	40					SDA 4...
SD-BRT 440 003 ...	■	□	T3	1.5	4	40					SDA 4...
SD-BRT 440 005 ...	■	□	T5	2	4	40					SDA 4...
SD-BRT 440 006 ...	■	□	T6	2.5	4	40					SDA 4...
SD-BRT 440 008 ...	■	□	T8	3.5	4	40					SDA 4...
SD-BRT 440 010 ...	■	□	T10	4.5	4	40					SDA 4...
SD-BRT 440 015 ...	■	□	T15	5	4	40					SDA 4...
SD-BRT 440 020 ...	■	□	T20	6	6	44					SDA 6...
SD-BRT 644 025 ...	■	□	T25	6	6	44					SDA 6...
SD-BRT 644 030 ...	■	□	T30	8	6	44					SDA 6...
SD-BRT 850 040 ...	■	□	T40	9	8	50					SDA 8...

UTILIS multidec® swiss type tools

Procedure recommendation for broaching of polygonal profiles

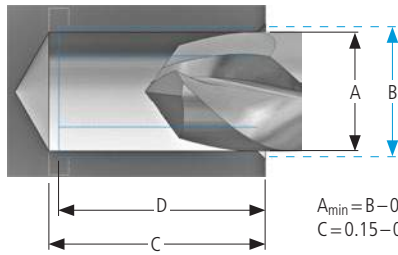

1. Create a tap hole (A) $\varnothing 0.02 - 0.05 \text{ mm} <$ than the width across flats (B), with a chamfer size of $0.02 - 0.05 >$ than the width across flats. Chamfer angle $90 - 120^\circ$.
2. Drilling depth of tap hole (C) $0.15 - 0.2 \text{ mm}$ deeper than the multi-edged profile (D).

$$A_{\min} = B - 0.02 \text{ mm}; A_{\max} = B - 0.05 \text{ mm}$$

$$C = 0.15 - 0.2 \text{ mm} > D$$

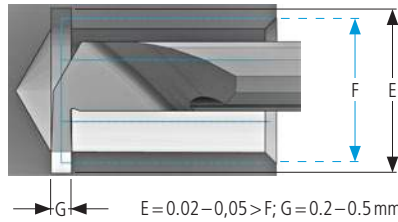
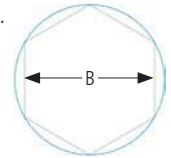

3. To avoid chip adhesion in the blind hole, radial undercut (E) $\varnothing 0.02 - 0.05 >$ than the radius of the broaching tool (F). Recess width (G) $0.2 - 0.5 \text{ mm}$.

$$E = 0.02 - 0.05 > F; G = 0.2 - 0.5 \text{ mm}$$

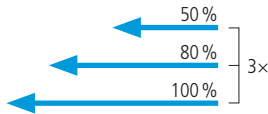
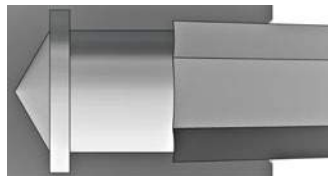

4. Feed: $25 - 30 \text{ mm/min}$ for titanium and stainless steel, up to 150 mm/min for materials with less strength (brass and low alloyed steels).
5. Cut distribution: 50 %, 80 % and 100 % of cutting depth in three strokes (remove chips after each stroke).

Drilling preparation

Broaching tool		Width across flats / size	Interior profile \varnothing	External profile \varnothing	pre-drill	ID turning
Square	SD-BRS 435 100	1.035 +0.01			DRS 338 095	SDG 435 092
	SD-BRS 435 150	1.535 +0.01			DRS 338 145	SDG 435 142
	SD-BRS 435 200	2.035 +0.01			DRS 338 175	SDG 435 142
	SD-BRS 644 300	3.07 +0.01			DRS 442 300	SDG 440 292
	SD-BRS 644 400	4.085 +0.01			DRS 650 400	SDG 440 392
	SD-BRS 850 500	5.085 +0.01			DRS 650 500	SDG 644 492
Hexagonal	SD-BRH 435 100	1.035 +0.01			DRS 338 095	SDG 435 092
	SD-BRH 435 150	1.535 +0.01			DRS 338 145	SDG 435 142
	SD-BRH 435 200	2.035 +0.01			DRS 338 175	SDG 435 142
	SD-BRH 435 250	2.55 +0.01			DRS 338 250	SDG 435 242
	SD-BRH 435 300	3.07 +0.01			DRS 442 300	SDG 440 292
	SD-BRH 644 350	3.57 +0.01			DRS 442 350	SDG 440 342
	SD-BRH 644 400	4.085 +0.01			DRS 650 400	SDG 440 392
	SD-BRH 850 500	5.085 +0.01			DRS 650 500	SDG 644 492
TORX	SD-BRT 440 002	T2	0.697	0.995	DRS 338 050	SDG 435 042
	SD-BRT 440 003	T3	0.824	1.198	DRS 338 075	SDG 435 072
	SD-BRT 440 005	T5	1.038	1.482	DRS 338 100	SDG 435 092
	SD-BRT 440 006	T6	1.233	1.762	DRS 338 110	SDG 435 092
	SD-BRT 440 008	T8	1.695	2.402	DRS 338 160	SDG 435 142
	SD-BRT 440 010	T10	2.004	2.828	DRS 338 175	SDG 435 142
	SD-BRT 440 015	T15	2.377	3.362	DRS 338 205	SDG 435 192
	SD-BRT 440 020	T20	2.789	3.947	DRS 338 250	SDG 435 242
	SD-BRT 644 025	T25	3.194	4.543	DRS 442 300	SDG 440 292
	SD-BRT 644 030	T30	3.982	5.635	DRS 442 350	SDG 440 342
SD-BRT 850 040	T40	4.789	6.79	DRS 650 450	SDG 644 442	

multidec®-DRILL contains of a wide range of high-precision solid carbide drills and centre drills. This includes the range from Ø 0.5 to 6 mm and centre drills with tip angles of 90°, 120° or 140°. multidec®-DRILL is characterised by its high stability and precision, and makes a decisive contribution to achieving high quality because of its excellent positioning capability and self-centering characteristic, and makes the work easier. The design also provides good chip removal and the tool life is increased significantly because of the HX and TX+ coatings.

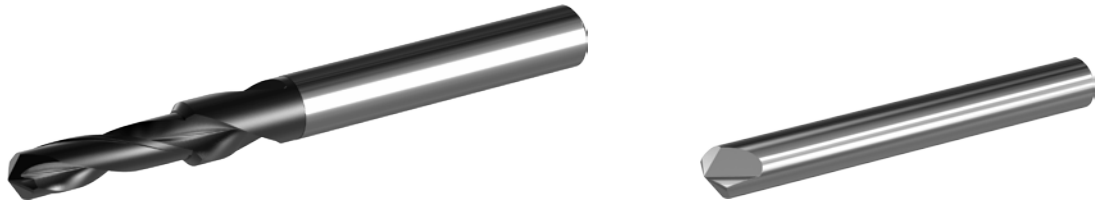

374

Benefits:

- High degree of accuracy and stability
- Self-centering
- Excellent positioning capability
- Good chip removal
- Complete range of solid carbide twist drills from Ø 0.5–6 mm
- Centre drills with tip angle of 90°, 120° or 140°
- HX and TX+ coatings for longer tool life
- Diameter coordinated to metric thread sizes
- Intermediate sizes possible on request

Overview – multidec®-DRILL

Technical information 11

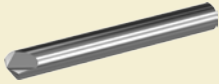
Center drills  376

Drills  377

Cutting specification / Feeds

	Spindel-Längen- Auswahl Spindel-Längen- Auswahl	Spindel-Längen- Auswahl Spindel-Längen- Auswahl	Spindel-Längen- Auswahl Spindel-Längen- Auswahl	Spindel-Längen- Auswahl Spindel-Längen- Auswahl
Spindel-Längen- Auswahl	125-200	180-250	200-250	-
Kategorie	I	II	III	IV
Spindel-Längen- Auswahl	***	***	***	***
Spindel-Längen- Auswahl	***	***	***	***
Spindel-Längen- Auswahl	***	***	***	***
Spindel-Längen- Auswahl	***	***	***	***
Spindel-Längen- Auswahl	***	***	***	***
Spindel-Längen- Auswahl	***	***	***	***
Spindel-Längen- Auswahl	***	***	***	***
Spindel-Längen- Auswahl	***	***	***	***

 379

Special tools – multidec4you® 600



Center drilling

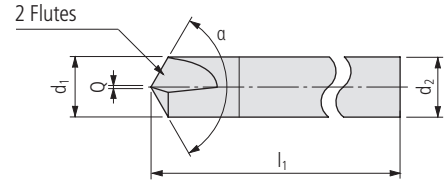
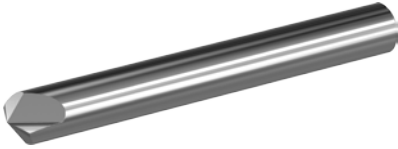

376

DRP ...

Order designation	Carbide □ 20			Dimensions																	
	UHM 20	UHM 20 HX	UHM 20 TX+	d ₁	d ₂	l ₁	Q	α													
R	○	●	●																		
	○	●	●																		
	○	●	●																		
	●	○	-																		
	-	-	○																		

UTILIS multidec® swiss type tools

PREMIUM-LINE

DRP 338 090 R ...	■	■	□	3	3	38	0.04	90°													
DRP 338 120 R ...	■	■	□	3	3	38	0.04	120°													
DRP 338 140 R ...	■	■	□	3	3	38	0.04	140°													
DRP 442 090 R ...	■	■	□	4	4	42	0.05	90°													
DRP 442 120 R ...	■	■	□	4	4	42	0.05	120°													
DRP 442 140 R ...	■	■	□	4	4	42	0.05	140°													
DRP 650 090 R ...	■	■	□	6	6	50	0.06	90°													
DRP 650 120 R ...	■	■	□	6	6	50	0.06	120°													
DRP 650 140 R ...	■	■	□	6	6	50	0.06	140°													

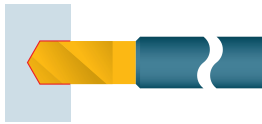

Drilling

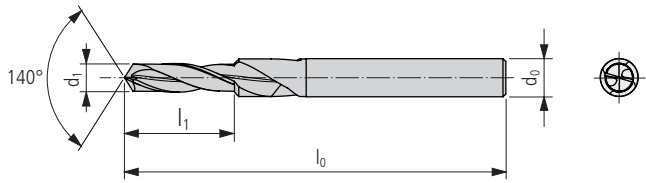

DRS ...

Order designation	Carbide □ 20			Dimensions				Core hole drill for			
	UHM 20	UHM 20 HX	UHM 20 TX+	d ₁	l ₁	d ₀	l ₀				

PREMIUM-LINE

DRS 338 050 ...	■	■	□	0.5	1.5	3	38					-
DRS 338 065 ...	■	■	□	0.65	2	3	38					T2
DRS 338 075 ...	■	■	□	0.75	2.3	3	38					M1 T3
DRS 338 085 ...	■	■	□	0.85	2.6	3	38					M1.1
DRS 338 095 ...	■	■	□	0.95	2.9	3	38					M1.2
DRS 338 100 ...	■	■	□	1	3	3	38					SW1 T5
DRS 338 110 ...	■	■	□	1.1	3.3	3	38					M1.4
DRS 338 120 ...	■	■	□	1.2	3.6	3	38					T6
DRS 338 125 ...	■	■	□	1.25	3.8	3	38					M1.6 0-80 UNF
DRS 338 145 ...	■	■	□	1.45	4.4	3	38					M1.8
DRS 338 150 ...	■	■	□	1.5	4.5	3	38					1-64 UNC 1-72 UNF SW1.5
DRS 338 160 ...	■	■	□	1.6	4.8	3	38					M2.0
DRS 338 165 ...	■	■	□	1.65	5	3	38					T8
DRS 338 175 ...	■	■	□	1.75	5.3	3	38					M2.2 2-56 UNC
DRS 338 190 ...	■	■	□	1.9	5.7	3	38					M2.3 2-64 UNF
DRS 338 195 ...	■	■	□	1.95	5.9	3	38					T10
DRS 338 200 ...	■	■	□	2	6	3	38					SW2
DRS 338 205 ...	■	■	□	2.05	6.2	3	38					M2.5 3-48 UNC
DRS 338 215 ...	■	■	□	2.15	6.5	3	38					3-56 UNF
DRS 338 230 ...	■	■	□	2.3	6.9	3	38					4-40 UNC T15
DRS 338 240 ...	■	■	□	2.4	7.2	3	38					4-48 UNF
DRS 338 250 ...	■	■	□	2.5	7.5	3	38					M3 SW2.5
DRS 338 260 ...	■	■	□	2.6	7.8	3	38					5-40 UNC
DRS 338 270 ...	■	■	□	2.7	8.1	3	38					5-44 UNF
DRS 338 275 ...	■	■	□	2.75	8.3	3	38					6-32 UNC T20
DRS 338 280 ...	■	■	□	2.8	8.4	3	38					-
DRS 442 290 ...	■	■	□	2.9	8.7	4	42					M3.5 6-40 UNF
DRS 442 300 ...	■	■	□	3	9	4	42					SW3
DRS 442 315 ...	■	■	□	3.15	9.5	4	42					T25
DRS 442 330 ...	■	■	□	3.3	9.9	4	42					M4
DRS 442 340 ...	■	■	□	3.4	10.2	4	42					8-32 UNC
DRS 442 350 ...	■	■	□	3.5	10.5	4	42					8-36 UNF SW3.5
DRS 442 370 ...	■	■	□	3.7	11.1	4	42					M4.5
DRS 650 390 ...	■	■	□	3.9	11.7	6	50					T30
DRS 650 400 ...	■	■	□	4	12	6	50					SW4
DRS 650 410 ...	■	■	□	4.1	12.3	6	50					10-32 UNF
DRS 650 425 ...	■	■	□	4.25	12.8	6	50					M5
DRS 650 450 ...	■	■	□	4.5	13.5	6	50					-
DRS 650 470 ...	■	■	□	4.7	14.1	6	50					T40
DRS 650 500 ...	■	■	□	5	15	6	50					M6 SW5
DRS 650 600 ...	■	■	□	6	18	6	50					M7 SW6



Drilling

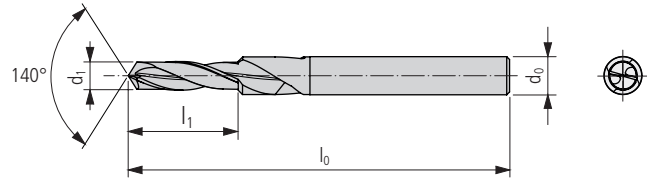

DRL ...

UTILIS
multidec[®]
swiss type tools

378

Order designation	Carbide □ 20			Dimensions							Core hole drill for
	UHM 20	UHM 20 HX	UHM 20 TX+	d ₁	l ₁	d ₀	l ₀				

PREMIUM-LINE

DRL 338 050 ...	■	■	□	0.5	3	3	38						-
DRL 338 065 ...	■	■	□	0.65	3.9	3	38						T2
DRL 338 075 ...	■	■	□	0.75	4.5	3	38						M1 T3
DRL 338 085 ...	■	■	□	0.85	5.1	3	38						M1.1
DRL 338 095 ...	■	■	□	0.95	5.7	3	38						M1.2
DRL 338 100 ...	■	■	□	1	6	3	38						SW1 T5
DRL 338 110 ...	■	■	□	1.1	6.6	3	38						M1.4
DRL 338 120 ...	■	■	□	1.2	7.2	3	38						T6
DRL 338 125 ...	■	■	□	1.25	7.5	3	38						M1.6 0-80 UNF
DRL 338 145 ...	■	■	□	1.45	8.7	3	38						M1.8
DRL 338 150 ...	■	■	□	1.5	9	3	38						1-64 UNC 1-72 UNF SW1.5
DRL 338 160 ...	■	■	□	1.6	9.6	3	38						M2
DRL 338 165 ...	■	■	□	1.65	9.9	3	38						T8
DRL 338 175 ...	■	■	□	1.75	10.5	3	38						M2.2 2-056 UNC
DRL 338 190 ...	■	■	□	1.9	11.4	3	38						M2.3 2-64 UNF
DRL 338 195 ...	■	■	□	1.95	11.7	3	38						T10
DRL 338 200 ...	■	■	□	2	12	3	38						SW2
DRL 338 205 ...	■	■	□	2.05	12.3	3	38						M2.5 3-48 UNC
DRL 338 215 ...	■	■	□	2.15	12.9	3	38						3-56 UNF
DRL 338 230 ...	■	■	□	2.3	13.8	3	38						4-40 UNC T15
DRL 338 240 ...	■	■	□	2.4	14.4	3	38						4-48 UNF
DRL 338 250 ...	■	■	□	2.5	15	3	38						M3 SW2.5
DRL 338 260 ...	■	■	□	2.6	15.6	3	38						5-40 UNC
DRL 338 270 ...	■	■	□	2.7	16.2	3	38						5-44 UNF
DRL 338 275 ...	■	■	□	2.75	16.5	3	38						6-32 UNC T20
DRL 338 280 ...	■	■	□	2.8	16.8	3	38						-
DRL 442 290 ...	■	■	□	2.9	17.4	4	42						M3.5 6-40 UNF
DRL 442 300 ...	■	■	□	3	18	4	42						SW3
DRL 442 315 ...	■	■	□	3.15	18.9	4	42						T25
DRL 442 330 ...	■	■	□	3.3	19.8	4	42						M4
DRL 442 340 ...	■	■	□	3.4	20.4	4	42						8-32 UNC
DRL 442 350 ...	■	■	□	3.5	21	4	42						8-36 UNF SW3.5
DRL 442 370 ...	■	■	□	3.7	22.2	4	42						M4.5
DRL 650 390 ...	■	■	□	3.9	23.4	6	50						T30
DRL 650 400 ...	■	■	□	4	24	6	50						SW4
DRL 650 410 ...	■	■	□	4.1	24.6	6	50						10-32 UNF
DRL 650 425 ...	■	■	□	4.25	25.5	6	50						M5
DRL 650 450 ...	■	■	□	4.5	27	6	50						-
DRL 650 470 ...	■	■	□	4.7	28.2	6	50						T40
DRL 650 500 ...	■	■	□	5	30	6	50						M6 SW5
DRL 660 600 ...	■	■	□	6	36	6	60						M7 SW6

Cutting specification

multidec®-DRILL

	Steel unalloyed			Steel low alloyed			Steel high alloyed		
Hardness value (HB)/(HRC)	125–300 HB			180–250 HB			200–350 HB		
Category	I			II			III		
Machining method	▼	▼▼	▼▼▼	▼	▼▼	▼▼▼	▼	▼▼	▼▼▼
Cutting speeds	v _c (m/min)								
Cutting material carbide									
UHM 20	–	–	35–50	–	–	35–50	–	–	20–45
UHM 20 HX	–	–	60–110	–	–	50–90	–	–	50–80
UHM 20 TX+	–	–	–	–	–	–	–	–	40–70

	Stainless steel			Stainless steel			Titanium		
Hardness value (HB)/(HRC)	180–220 HB			220–330 HB			–		
Category	V			VI			IV		
Machining method	▼	▼▼	▼▼▼	▼	▼▼	▼▼▼	▼	▼▼	▼▼▼
Cutting speeds	v _c (m/min)								
Cutting material carbide									
UHM 20	–	–	20–30	–	–	20–30	–	–	10–40
UHM 20 HX	–	–	60–70	–	–	60–70	–	–	20–40
UHM 20 TX+	–	–	40–70	–	–	40–60	–	–	20–40

	Aluminum			Brass			Hard materials		
Hardness value (HB)/(HRC)	60–130 HB			–			45–70 HRC		
Category	VII			VIII			X		
Machining method	▼	▼▼	▼▼▼	▼	▼▼	▼▼▼	▼	▼▼	▼▼▼
Cutting speeds	v _c (m/min)								
Cutting material carbide									
UHM 20	–	–	60–100	–	–	30–80	–	–	–
UHM 20 HX	–	–	50–135	–	–	50–100	–	–	–
UHM 20 TX+	–	–	–	–	–	–	–	–	15–40

Feeds

multidec®-DRILL

DRP – DRS – DRL

	Steel unalloyed	Steel low alloyed	Steel high alloyed	Stainless steel	Titanium	Aluminum / Brass	Hard materials
D (mm)	f (mm/U)	f (mm/U)	f (mm/U)	f (mm/U)	f (mm/U)	f (mm/U)	f (mm/U)
≤1	0.03-0.07	0.03-0.07	0.03-0.07	0.03-0.07	0.03-0.07	0.03-0.08	0.03-0.07
2	0.03-0.08	0.03-0.08	0.03-0.08	0.03-0.08	0.03-0.08	0.04-0.09	0.03-0.08
3	0.04-0.10	0.04-0.10	0.04-0.10	0.04-0.10	0.04-0.10	0.05-0.11	0.04-0.10
4	0.05-0.11	0.05-0.11	0.05-0.11	0.05-0.11	0.05-0.11	0.06-0.12	0.05-0.11
5	0.06-0.12	0.06-0.12	0.06-0.12	0.06-0.12	0.06-0.12	0.07-0.14	0.06-0.12
6	0.07-0.14	0.07-0.14	0.07-0.14	0.07-0.14	0.07-0.14	0.09-0.16	0.07-0.14

In thread milling, the thread is produced by helical interpolation. The cutting process enables threads with one or two teeth to be obtained with a nominal diameter of 1 mm or more.



Advantages:

- The thread depth is equal to the drill depth
- Lower torque than with tapping and roll form tapping
- Short milling chips avoid chip problems
- High Speed Cutting (HSC) possible
- Reliable process with longer life time

The use of a tool with just one row of teeth is needed in the following situations:

- If there is not enough room in the bottom of the blind hole.
- If the cutting pressure with a tool with two rows of teeth is too great.
- If the tool is also used for deviating pitches.



Overview – multidec®-THREADMILL

Technical information

11

Thread milling tools



WHS ...

382

WHL ...

383

WHA ...

384

WHB ...

385

WHC ...

386

WHD ...

388

Cutting specification

	WHS WHL WHA WHB WHC WHD	WHL WHL WHL WHL WHL WHL	WHL WHL WHL WHL WHL WHL	WHL WHL WHL WHL WHL WHL	WHL WHL WHL WHL WHL WHL
WHL WHL WHL WHL WHL WHL	125-200	150-225	200-300	—	—
WHL WHL WHL WHL WHL WHL	I	II	III	IV	V
WHL WHL WHL WHL WHL WHL	▼ ▼ ▼ ▼ ▼ ▼ ▼ ▼	▼ ▼ ▼ ▼ ▼ ▼ ▼ ▼	▼ ▼ ▼ ▼ ▼ ▼ ▼ ▼	▼ ▼ ▼ ▼ ▼ ▼ ▼ ▼	▼ ▼ ▼ ▼ ▼ ▼ ▼ ▼

390

Application recommendation

392

Special tools – multidec4you®

600

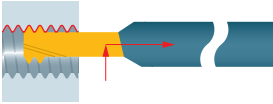

3 flutes, 2 teeth (full profile metric)

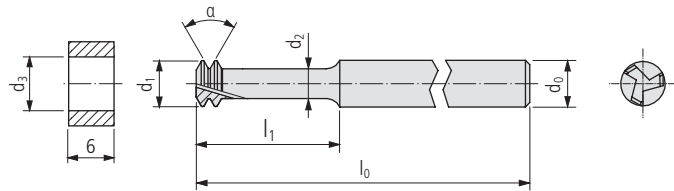
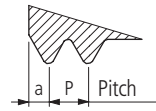

WHS ... (Short version)

382

UTILIS
multidec
swiss type tools

Order designation	Carbide □ 20			Standard	Dimensions								Core hole	
	UHM 20	UHM 20 HX	UHM 20 TX+		P	l ₁	d ₁	d ₂	a	d ₀	l ₀	α	d ₃	

PREMIUM-LINE

WHS 338 010 025 ...	■	■	□	M1	0.25	2.3	0.64	0.24	0.155	3	38	60°	0.75	0/+0.03
WHS 338 012 025 ...	■	■	□	M1.2	0.25	2.8	0.84	0.44	0.155	3	38	60°	0.95	0/+0.03
WHS 338 014 030 ...	■	■	□	M1.4	0.3	3.2	0.98	0.53	0.18	3	38	60°	1.1	0/+0.04
WHS 338 016 035 ...	■	■	□	M1.6	0.35	3.7	1.12	0.61	0.205	3	38	60°	1.25	0/+0.04
WHS 338 018 035 ...	■	■	□	M1.8	0.35	4.1	1.32	0.81	0.205	3	38	60°	1.45	0/+0.04
WHS 338 020 040 ...	■	■	□	M2	0.4	4.6	1.46	0.9	0.23	3	38	60°	1.6	0/+0.05
WHS 338 022 045 ...	■	■	□	M2.2	0.45	5.1	1.6	0.98	0.255	3	38	60°	1.75	0/+0.05
WHS 338 023 040 ...	■	■	□	M2.3	0.4	5.2	1.76	1.2	0.23	3	38	60°	1.9	0/+0.05
WHS 338 025 045 ...	■	■	□	M2.5	0.45	5.8	1.9	1.28	0.255	3	38	60°	2.05	0/+0.05
WHS 338 030 050 ...	■	■	□	M3	0.5	6.9	2.34	1.67	0.28	3	38	60°	2.5	0/+0.05
WHS 338 035 060 ...	■	■	□	M3.5	0.6	8.1	2.71	1.93	0.33	3	38	60°	2.9	0/+0.06
WHS 442 040 070 ...	■	■	□	M4	0.7	9.2	3.09	2.2	0.38	4	42	60°	3.3	0/+0.06
WHS 442 045 075 ...	■	■	□	M4.5	0.75	10.4	3.53	2.56	0.405	4	42	60°	3.75	0/+0.07
WHS 442 050 080 ...	■	■	□	M5	0.8	11.5	3.97	2.95	0.43	4	42	60°	4.2	0/+0.07

Application recommendation □ 392

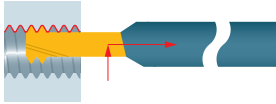

3 flutes, 2 teeth (full profile metric)



WHL ... (Long version)

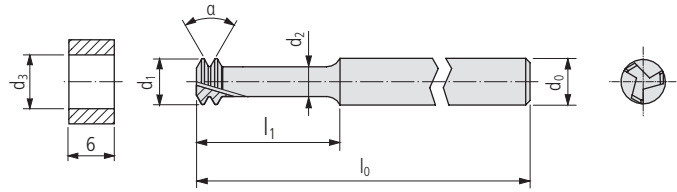
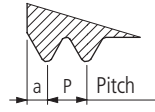

Order designation	Carbide □ 20			Standard	Dimensions								Core hole	
	UHM 20	UHM 20 HX	UHM 20 TX+		P	l ₁	d ₁	d ₂	a	d ₀	l ₀	a	d ₃	

PREMIUM-LINE

WHL 338 010 025 ...	■	■	□	M1	0.25	4.6	0.64	0.24	0.155	3	38	60°	0.75	0/+0.03
WHL 338 012 025 ...	■	■	□	M1.2	0.25	5.5	0.84	0.44	0.155	3	38	60°	0.95	0/+0.03
WHL 338 014 030 ...	■	■	□	M1.4	0.3	6.4	0.98	0.53	0.18	3	38	60°	1.1	0/+0.04
WHL 338 016 035 ...	■	■	□	M1.6	0.35	7.4	1.12	0.61	0.205	3	38	60°	1.25	0/+0.04
WHL 338 018 035 ...	■	■	□	M1.8	0.35	8.3	1.32	0.81	0.205	3	38	60°	1.45	0/+0.04
WHL 338 020 040 ...	■	■	□	M2	0.4	9.2	1.46	0.9	0.23	3	38	60°	1.6	0/+0.05
WHL 338 022 045 ...	■	■	□	M2.2	0.45	10.1	1.6	0.98	0.255	3	38	60°	1.75	0/+0.05
WHL 338 023 040 ...	■	■	□	M2.3	0.4	10.4	1.76	1.2	0.23	3	38	60°	1.9	0/+0.05
WHL 338 025 045 ...	■	■	□	M2.5	0.45	11.5	1.9	1.28	0.255	3	38	60°	2.05	0/+0.05
WHL 338 030 050 ...	■	■	□	M3	0.5	13.8	2.34	1.67	0.28	3	38	60°	2.5	0/+0.05
WHL 338 035 060 ...	■	■	□	M3.5	0.6	16.1	2.71	1.93	0.33	3	38	60°	2.9	0/+0.06
WHL 442 040 070 ...	■	■	□	M4	0.7	18.4	3.09	2.2	0.38	4	42	60°	3.3	0/+0.06
WHL 442 045 075 ...	■	■	□	M4.5	0.75	20.7	3.53	2.56	0.405	4	42	60°	3.75	0/+0.07
WHL 442 050 080 ...	■	■	□	M5	0.8	23	3.97	2.95	0.43	4	42	60°	4.2	0/+0.07

Application recommendation □ 392

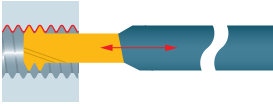

3 flutes, 2 teeth (full profile metric)
Strengthen type

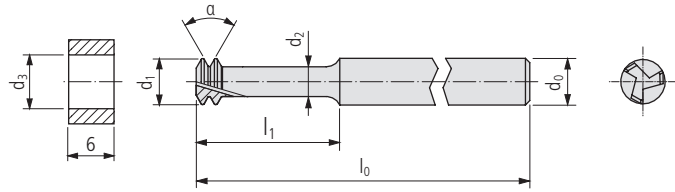
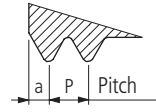

WHA ... (Short version)

384

UTILIS
multidec
swiss type tools

Order designation	Carbide □ 20			Standard	Dimensions								Core hole	
	UHM 20	UHM 20 HX	UHM 20 TX+		P	l ₁	d ₁	d ₂	a	d ₀	l ₀	α	d ₃	

PREMIUM-LINE

WHA 338 010 025 ...	■	■	□	M1.0	0.25	2.3	0.83	0.41	0.155	3	38	60°	0.75	0/+0.03
WHA 338 012 025 ...	■	■	□	M1.2	0.25	2.8	1.03	0.61	0.155	3	38	60°	0.95	0/+0.03
WHA 338 014 030 ...	■	■	□	M1.4	0.3	3.2	1.21	0.74	0.18	3	38	60°	1.1	0/+0.04
WHA 338 016 035 ...	■	■	□	M1.6	0.35	3.7	1.39	0.88	0.205	3	38	60°	1.25	0/+0.04
WHA 338 018 035 ...	■	■	□	M1.8	0.35	4.1	1.59	1.08	0.205	3	38	60°	1.45	0/+0.04
WHA 338 020 040 ...	■	■	□	M2.0	0.4	4.6	1.76	1.19	0.23	3	38	60°	1.6	0/+0.05
WHA 338 022 045 ...	■	■	□	M2.2	0.45	5.1	1.94	1.31	0.255	3	38	60°	1.75	0/+0.05
WHA 338 023 040 ...	■	■	□	M2.3	0.4	5.2	2.06	1.49	0.23	3	38	60°	1.9	0/+0.05

Application recommendation □ 392

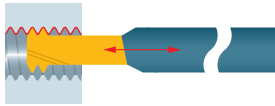

3 flutes, 2 teeth (full profile metric)
Strengthen type

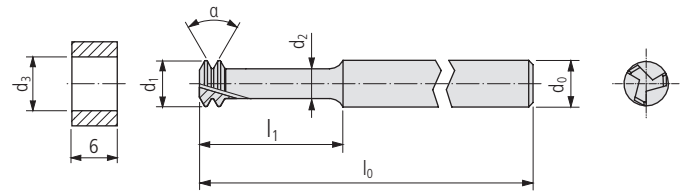
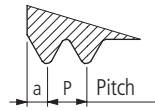

WHB ... (Long version)

Order designation	Carbide □ 20			Standard	Dimensions								Core hole	
	UHM 20	UHM 20 HX	UHM 20 TX+		P	l ₁	d ₁	d ₂	a	d ₀	l ₀	a	d ₃	

PREMIUM-LINE

WHB 338 010 025 ...	■	■	□	M1.0	0.25	4.6	0.83	0.41	0.155	3	38	60°	0.75	0/+0.03
WHB 338 012 025 ...	■	■	□	M1.2	0.25	5.6	1.03	0.61	0.155	3	38	60°	0.95	0/+0.03
WHB 338 014 030 ...	■	■	□	M1.4	0.3	6.4	1.21	0.74	0.18	3	38	60°	1.1	0/+0.04
WHB 338 016 035 ...	■	■	□	M1.6	0.35	7.4	1.39	0.88	0.205	3	38	60°	1.25	0/+0.04
WHB 338 018 035 ...	■	■	□	M1.8	0.35	8.2	1.59	1.08	0.205	3	38	60°	1.45	0/+0.04
WHB 338 020 040 ...	■	■	□	M2.0	0.4	9.2	1.76	1.19	0.23	3	38	60°	1.6	0/+0.05
WHB 338 022 045 ...	■	■	□	M2.2	0.45	10.2	1.94	1.31	0.255	3	38	60°	1.75	0/+0.05
WHB 338 023 040 ...	■	■	□	M2.3	0.4	10.4	2.06	1.49	0.23	3	38	60°	1.9	0/+0.05

Application recommendation □ 392

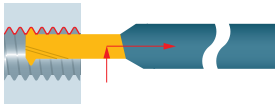

3 flutes, 1 tooth (full profile metric)

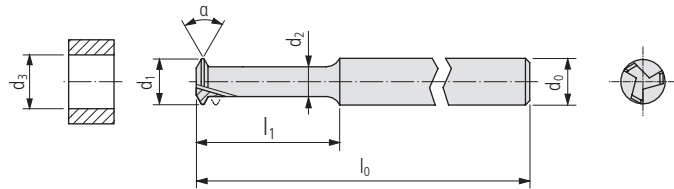
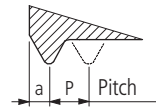

WHC ... (Short version)

Order designation	Carbide □ 20			Standard	Dimensions								Core hole	
	UHM 20	UHM 20 HX	UHM 20 TX+		P	l ₁	d ₁	d ₂	a	d ₀	l ₀	α	d ₃	

PREMIUM-LINE

WHC 338 010 025 ...	■	■	□	M1.0	0.25	2.5	0.68	0.3	0.155	3	38	60°	0.75	0/+0.03
WHC 338 012 025 ...	■	■	□	M1.2	0.25	2.7	0.88	0.5	0.155	3	38	60°	0.95	0/+0.03
WHC 338 014 025 ...	■	■	□	M1.4	0.25	2.9	1.08	0.7	0.155	3	38	60°	1.15	0/+0.03
WHC 338 016 025 ...	■	■	□	M1.6	0.25	3.1	1.28	0.9	0.155	3	38	60°	1.35	0/+0.03
WHC 338 018 025 ...	■	■	□	M1.8	0.25	3.3	1.48	1.1	0.155	3	38	60°	1.55	0/+0.03
WHC 338 020 025 ...	■	■	□	M2.0	0.25	3.5	1.68	1.3	0.155	3	38	60°	1.75	0/+0.03
WHC 338 014 030 ...	■	■	□	M1.4	0.3	3.2	1.02	0.58	0.18	3	38	60°	1.1	0/+0.04
WHC 338 016 030 ...	■	■	□	M1.6	0.3	3.4	1.22	0.78	0.18	3	38	60°	1.3	0/+0.04
WHC 338 018 030 ...	■	■	□	M1.8	0.3	3.6	1.42	0.98	0.18	3	38	60°	1.5	0/+0.04
WHC 338 020 030 ...	■	■	□	M2.0	0.3	3.8	1.62	1.18	0.18	3	38	60°	1.7	0/+0.04
WHC 338 022 030 ...	■	■	□	M2.2	0.3	4	1.82	1.38	0.18	3	38	60°	1.9	0/+0.04
WHC 338 016 035 ...	■	■	□	M1.6	0.35	3.7	1.16	0.65	0.205	3	38	60°	1.25	0/+0.04
WHC 338 018 035 ...	■	■	□	M1.8	0.35	3.9	1.36	0.85	0.205	3	38	60°	1.45	0/+0.04
WHC 338 020 035 ...	■	■	□	M2.0	0.35	4.1	1.56	1.05	0.205	3	38	60°	1.65	0/+0.04
WHC 338 022 035 ...	■	■	□	M2.2	0.35	4.3	1.76	1.25	0.205	3	38	60°	1.85	0/+0.04
WHC 338 025 035 ...	■	■	□	M2.5	0.35	4.6	2.06	1.55	0.205	3	38	60°	2.15	0/+0.04
WHC 338 030 035 ...	■	■	□	M3.0	0.35	5.1	2.56	2.05	0.205	3	38	60°	2.65	0/+0.04
WHC 338 035 035 ...	■	■	□	M3.5	0.35	5.6	3.06	2.55	0.205	3	38	60°	3.15	0/+0.04
WHC 338 020 040 ...	■	■	□	M2.0	0.4	4.4	1.50	0.92	0.23	3	38	60°	1.6	0/+0.05
WHC 338 022 040 ...	■	■	□	M2.2	0.4	4.6	1.70	1.12	0.23	3	38	60°	1.8	0/+0.05
WHC 338 025 040 ...	■	■	□	M2.5	0.4	4.9	2.00	1.42	0.23	3	38	60°	2.1	0/+0.05
WHC 338 030 040 ...	■	■	□	M3	0.4	5.4	2.50	1.92	0.23	3	38	60°	2.6	0/+0.05
WHC 338 035 040 ...	■	■	□	M3.5	0.4	5.9	2.98	2.4	0.23	3	38	60°	3.1	0/+0.05
WHC 338 022 045 ...	■	■	□	M2.2	0.45	4.9	1.64	1	0.255	3	38	60°	1.75	0/+0.05
WHC 338 025 045 ...	■	■	□	M2.5	0.45	5.2	1.94	1.3	0.255	3	38	60°	2.05	0/+0.05
WHC 338 030 045 ...	■	■	□	M3	0.45	5.7	2.44	1.8	0.255	3	38	60°	2.55	0/+0.05
WHC 338 035 045 ...	■	■	□	M3.5	0.45	6.2	2.94	2.3	0.255	3	38	60°	3.05	0/+0.05
WHC 442 040 045 ...	■	■	□	M4	0.45	6.7	3.44	2.8	0.255	3	38	60°	3.55	0/+0.05
WHC 338 030 050 ...	■	■	□	M3	0.5	6	2.38	1.68	0.28	3	38	60°	2.5	0/+0.05
WHC 338 035 050 ...	■	■	□	M3.5	0.5	6.5	2.88	2.18	0.28	3	38	60°	3	0/+0.05
WHC 442 040 050 ...	■	■	□	M4	0.5	7	3.38	2.68	0.28	4	42	60°	3.5	0/+0.05
WHC 442 045 050 ...	■	■	□	M4.5	0.5	7.5	3.88	3.18	0.28	4	42	60°	4	0/+0.05
WHC 442 035 060 ...	■	■	□	M3.5	0.6	7.1	2.75	1.95	0.33	4	42	60°	2.9	0/+0.06
WHC 442 040 060 ...	■	■	□	M4	0.6	7.6	3.25	2.45	0.33	4	42	60°	3.4	0/+0.06
WHC 442 045 060 ...	■	■	□	M4.5	0.6	8.1	3.75	2.95	0.33	4	42	60°	3.9	0/+0.06
WHC 442 040 070 ...	■	■	□	M4	0.7	8.2	3.13	2.19	0.38	4	42	60°	3.3	0/+0.06
WHC 442 045 070 ...	■	■	□	M4.5	0.7	8.7	3.63	2.71	0.38	4	42	60°	3.8	0/+0.06
WHC 442 045 075 ...	■	■	□	M4.5	0.75	9	3.57	2.57	0.405	4	42	60°	3.75	0/+0.07
WHC 442 050 075 ...	■	■	□	M5	0.75	9.5	3.98	2.98	0.405	4	42	60°	4.25	0/+0.07
WHC 442 050 080 ...	■	■	□	M5	0.8	9.8	3.98	2.92	0.43	4	42	60°	4.2	0/+0.07

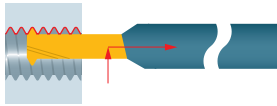

3 flutes, 1 tooth (full profile UNC/UNF)

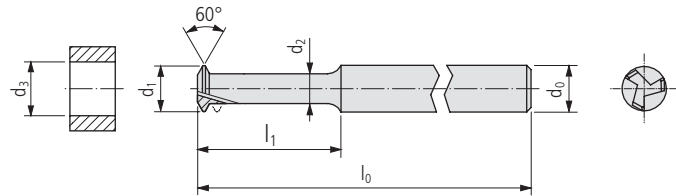
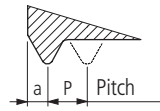

WHC ... UNC ... (INCH) (Short version)

Order designation	Carbide □ 20			Standard	Dimensions							Core hole	
	UHM 20	UHM 20 HX	UHM 20 TX+		P	P	l ₁	d ₁	d ₂	a	d ₀	l ₀	d ₃

PREMIUM-LINE

WHC 338-01-64 UNC ...	■	■	□	1-64	64	0.397	4.2	1.36	0.81	0.228	3	38	1.5	0/+0.04
WHC 338-02-56 UNC ...	■	■	□	2-56	56	0.454	4.9	1.62	1	0.257	3	38	1.78	0/+0.05
WHC 338-03-48 UNC ...	■	■	□	3-48	48	0.529	5.7	1.86	1.15	0.294	3	38	2.05	0/+0.05
WHC 442-04-40 UNC ...	■	■	□	4-40	40	0.635	6.7	2.06	1.22	0.347	4	42	2.27	0/+0.06
WHC 442-05-40 UNC ...	■	■	□	5-40	40	0.635	7	2.39	1.55	0.347	4	42	2.59	0/+0.06
WHC 442-06-32 UNC ...	■	■	□	6-32	32	0.794	8.3	2.52	1.49	0.427	4	42	2.77	0/+0.07
WHC 442-08-32 UNC ...	■	■	□	8-32	32	0.794	8.9	3.18	2.16	0.427	4	42	3.42	0/+0.07

WHC ... UNF ... (INCH) (Short version)

Order designation	Carbide □ 20			Standard	Dimensions							Core hole	
	UHM 20	UHM 20 HX	UHM 20 TX+		P	P	l ₁	d ₁	d ₂	a	d ₀	l ₀	d ₃

PREMIUM-LINE

WHC 338-00-80 UNF ...	■	■	□	0-80	80	0.317	3.4	1.12	0.67	0.188	3	38	1.25	0/+0.04
WHC 338-01-72 UNF ...	■	■	□	1-72	72	0.353	4	1.41	0.91	0.206	3	38	1.55	0/+0.04
WHC 338-02-64 UNF ...	■	■	□	2-64	64	0.396	4.1	1.69	1.14	0.228	3	38	1.9	0/+0.04
WHC 338-03-56 UNF ...	■	■	□	3-56	56	0.453	5.2	1.95	1.32	0.257	3	38	2.15	0/+0.05
WHC 338-04-48 UNF ...	■	■	□	4-48	48	0.529	6	2.19	1.46	0.294	3	38	2.4	0/+0.05
WHC 338-05-44 UNF ...	■	■	□	5-44	44	0.577	6.6	2.46	1.68	0.318	3	38	2.7	0/+0.05
WHC 442-06-40 UNF ...	■	■	□	6-40	40	0.635	7.3	2.72	1.87	0.347	4	42	2.95	0/+0.06
WHC 442-08-36 UNF ...	■	■	□	8-36	36	0.705	8.4	3.29	2.37	0.382	4	42	3.5	0/+0.06
WHC 442-10-32 UNF ...	■	■	□	10-32	32	0.794	9.6	3.84	2.82	0.427	4	42	4.1	0/+0.07

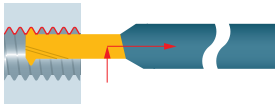

3 flutes, 1 tooth (full profile metric)

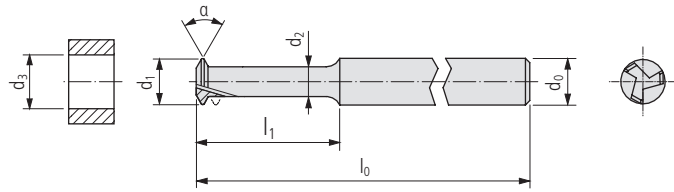
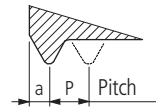

WHD ... (Long version)

Order designation	Carbide □ 20			Standard	Dimensions								Core hole	
	UHM 20	UHM 20 HX	UHM 20 TX+		P	l ₁	d ₁	d ₂	a	d ₀	l ₀	a	d ₃	

PREMIUM-LINE

WHD 338 010 025 ...	■	■	□	M1.0	0.25	3.5	0.68	0.3	0.155	3	38	60°	0.75	0/+0.03
WHD 338 012 025 ...	■	■	□	M1.2	0.25	3.9	0.88	0.5	0.155	3	38	60°	0.95	0/+0.03
WHD 338 014 025 ...	■	■	□	M1.4	0.25	4.3	1.08	0.7	0.155	3	38	60°	1.15	0/+0.03
WHD 338 016 025 ...	■	■	□	M1.6	0.25	4.7	1.28	0.9	0.155	3	38	60°	1.35	0/+0.03
WHD 338 018 025 ...	■	■	□	M1.8	0.25	5.1	1.48	1.1	0.155	3	38	60°	1.55	0/+0.03
WHD 338 020 025 ...	■	■	□	M2.0	0.25	5.5	1.68	1.3	0.155	3	38	60°	1.75	0/+0.03
WHD 338 014 030 ...	■	■	□	M1.4	0.3	4.6	1.02	0.58	0.18	3	38	60°	1.1	0/+0.04
WHD 338 016 030 ...	■	■	□	M1.6	0.3	5	1.22	0.78	0.18	3	38	60°	1.3	0/+0.04
WHD 338 018 030 ...	■	■	□	M1.8	0.3	5.4	1.42	0.98	0.18	3	38	60°	1.5	0/+0.04
WHD 338 020 030 ...	■	■	□	M2.0	0.3	5.8	1.62	1.18	0.18	3	38	60°	1.7	0/+0.04
WHD 338 022 030 ...	■	■	□	M2.2	0.3	6.2	1.82	1.38	0.18	3	38	60°	1.9	0/+0.04
WHD 338 016 035 ...	■	■	□	M1.6	0.35	5.3	1.16	0.65	0.205	3	38	60°	1.25	0/+0.04
WHD 338 018 035 ...	■	■	□	M1.8	0.35	5.7	1.36	0.85	0.205	3	38	60°	1.45	0/+0.04
WHD 338 020 035 ...	■	■	□	M2.0	0.35	6.1	1.56	1.05	0.205	3	38	60°	1.65	0/+0.04
WHD 338 022 035 ...	■	■	□	M2.2	0.35	6.5	1.76	1.25	0.205	3	38	60°	1.85	0/+0.04
WHD 338 025 035 ...	■	■	□	M2.5	0.35	7.1	2.06	1.55	0.205	3	38	60°	2.15	0/+0.04
WHD 338 030 035 ...	■	■	□	M3.0	0.35	8.1	2.56	2.05	0.205	3	38	60°	2.65	0/+0.04
WHD 338 035 035 ...	■	■	□	M3.5	0.35	9.1	3.06	2.55	0.205	3	38	60°	3.15	0/+0.04
WHD 338 020 040 ...	■	■	□	M2.0	0.4	6.4	1.50	0.93	0.23	3	38	60°	1.6	0/+0.05
WHD 338 022 040 ...	■	■	□	M2.2	0.4	6.8	1.70	1.13	0.23	3	38	60°	1.8	0/+0.05
WHD 338 025 040 ...	■	■	□	M2.5	0.4	7.4	2.00	1.43	0.23	3	38	60°	2.1	0/+0.05
WHD 338 030 040 ...	■	■	□	M3	0.4	8.4	2.50	1.93	0.23	3	38	60°	2.6	0/+0.05
WHD 338 035 040 ...	■	■	□	M3.5	0.4	9.4	2.98	2.41	0.23	3	38	60°	3.1	0/+0.05
WHD 338 022 045 ...	■	■	□	M2.2	0.45	7.1	1.64	1.01	0.255	3	38	60°	1.75	0/+0.05
WHD 338 025 045 ...	■	■	□	M2.5	0.45	7.7	1.94	1.31	0.255	3	38	60°	2.05	0/+0.05
WHD 338 030 045 ...	■	■	□	M3	0.45	8.7	2.44	1.81	0.255	3	38	60°	2.55	0/+0.05
WHD 338 035 045 ...	■	■	□	M3.5	0.45	9.7	2.94	2.31	0.255	3	38	60°	3.05	0/+0.05
WHD 442 040 045 ...	■	■	□	M4	0.45	10.7	3.44	2.81	0.255	3	38	60°	3.55	0/+0.05
WHD 338 030 050 ...	■	■	□	M3	0.5	9	2.38	1.69	0.28	3	38	60°	2.5	0/+0.05
WHD 338 035 050 ...	■	■	□	M3.5	0.5	10	2.88	2.19	0.28	3	38	60°	3	0/+0.05
WHD 442 040 050 ...	■	■	□	M4	0.5	11	3.38	2.69	0.28	4	42	60°	3.5	0/+0.05
WHD 442 045 050 ...	■	■	□	M4.5	0.5	12	3.88	3.19	0.28	4	42	60°	4	0/+0.05
WHD 442 035 060 ...	■	■	□	M3.5	0.6	10.6	2.75	1.95	0.33	4	42	60°	2.9	0/+0.06
WHD 442 040 060 ...	■	■	□	M4	0.6	11.6	3.25	2.45	0.33	4	42	60°	3.4	0/+0.06
WHD 442 045 060 ...	■	■	□	M4.5	0.6	12.6	3.75	2.95	0.33	4	42	60°	3.9	0/+0.06
WHD 442 040 070 ...	■	■	□	M4	0.7	12.2	3.13	2.21	0.38	4	42	60°	3.3	0/+0.06
WHD 442 045 070 ...	■	■	□	M4.5	0.7	13.2	3.63	2.71	0.38	4	42	60°	3.8	0/+0.06
WHD 442 045 075 ...	■	■	□	M4.5	0.75	13.5	3.57	2.59	0.405	4	42	60°	3.75	0/+0.07
WHD 442 050 075 ...	■	■	□	M5	0.75	14.5	3.98	3.00	0.405	4	42	60°	4.25	0/+0.07
WHD 442 050 080 ...	■	■	□	M5	0.8	14.8	3.98	2.94	0.43	4	42	60°	4.2	0/+0.07

388
UTILIS
multidec
swiss type tools

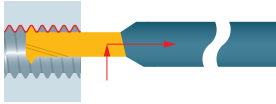

3 flutes, 1 tooth (full profile UNC/UNF)

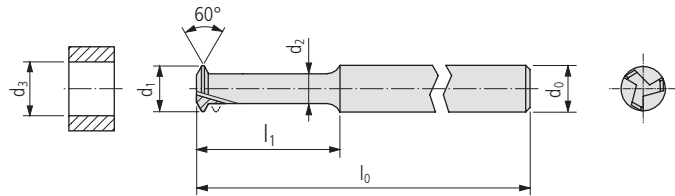
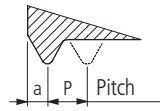

WHD ... UNC ... (INCH) (Long version)

Order designation	Carbide □ 20			Standard	Dimensions							Core hole	
	UHM 20	UHM 20 HX	UHM 20 TX+		P	P	l ₁	d ₁	d ₂	a	d ₀	l ₀	d ₃

PREMIUM-LINE

WHD 338-01-64 UNC ...	■	■	□	1-64	64	0.397	6.1	1.36	0.81	0.228	3	38	1.5	0/+0.04
WHD 338-02-56 UNC ...	■	■	□	2-56	56	0.454	7.1	1.62	1	0.257	3	38	1.78	0/+0.05
WHD 338-03-48 UNC ...	■	■	□	3-48	48	0.529	8.2	1.86	1.15	0.294	3	38	2.05	0/+0.05
WHD 442-04-40 UNC ...	■	■	□	4-40	40	0.635	9.5	2.06	1.22	0.347	4	42	2.27	0/+0.06
WHD 442-05-40 UNC ...	■	■	□	5-40	40	0.635	10.2	2.39	1.55	0.347	4	42	2.59	0/+0.06
WHD 442-06-32 UNC ...	■	■	□	6-32	32	0.794	11.8	2.52	1.49	0.427	4	42	2.77	0/+0.07
WHD 442-08-32 UNC ...	■	■	□	8-32	32	0.794	13.1	3.18	2.16	0.427	4	42	3.42	0/+0.07

WHD ... UNF ... (INCH) (Long version)

Order designation	Carbide □ 20			Standard	Dimensions							Core hole	
	UHM 20	UHM 20 HX	UHM 20 TX+		P	P	l ₁	d ₁	d ₂	a	d ₀	l ₀	d ₃

PREMIUM-LINE

WHD 338-00-80 UNF ...	■	■	□	0-80	80	0.317	5	1.12	0.67	0.188	3	38	1.25	0/+0.04
WHD 338-01-72 UNF ...	■	■	□	1-72	72	0.353	5.8	1.41	0.91	0.206	3	38	1.55	0/+0.04
WHD 338-02-64 UNF ...	■	■	□	2-64	64	0.396	6.8	1.69	1.14	0.228	3	38	1.9	0/+0.04
WHD 338-03-56 UNF ...	■	■	□	3-56	56	0.453	7.8	1.95	1.32	0.257	3	38	2.15	0/+0.05
WHD 338-04-48 UNF ...	■	■	□	4-48	48	0.529	8.9	2.19	1.46	0.294	3	38	2.4	0/+0.05
WHD 338-05-44 UNF ...	■	■	□	5-44	44	0.577	9.8	2.46	1.68	0.318	3	38	2.7	0/+0.05
WHD 442-06-40 UNF ...	■	■	□	6-40	40	0.635	10.8	2.72	1.87	0.347	4	42	2.95	0/+0.06
WHD 442-08-36 UNF ...	■	■	□	8-36	36	0.705	12.6	3.29	2.37	0.382	4	42	3.5	0/+0.06
WHD 442-10-32 UNF ...	■	■	□	10-32	32	0.794	14.4	3.84	2.82	0.427	4	42	4.1	0/+0.07

	Steel unalloyed			Steel low alloyed			Steel high alloyed		
Hardness value (HB)/(HRC)	125–300 HB			180–250 HB			200–350 HB		
Category	I			II			III		
Machining method	▼	▼▼	▼▼▼	▼	▼▼	▼▼▼	▼	▼▼	▼▼▼
Cutting speeds	v _c (m/min)								
Cutting material carbide									
UHM 20	–	–	20–120	–	–	20–100	–	–	20–90
UHM 20 HX	–	–	30–160	–	–	30–140	–	–	30–130
UHM 20 TX+	–	–	–	–	–	–	–	–	30–100

	Stainless steel			Stainless steel			Titanium		
Hardness value (HB)/(HRC)	180–220 HB			220–330 HB			–		
Category	V			VI			IV		
Machining method	▼	▼▼	▼▼▼	▼	▼▼	▼▼▼	▼	▼▼	▼▼▼
Cutting speeds	v _c (m/min)								
Cutting material carbide									
UHM 20	–	–	20–80	–	–	20–60	–	–	20–70
UHM 20 HX	–	–	30–120	–	–	30–100	–	–	30–100
UHM 20 TX+	–	–	30–100	–	–	30–80	–	–	30–80

	Aluminum			Brass			Hard materials		
Hardness value (HB)/(HRC)	60–130 HB			–			45–70 HRC		
Category	VII			VIII			X		
Machining method	▼	▼▼	▼▼▼	▼	▼▼	▼▼▼	▼	▼▼	▼▼▼
Cutting speeds	v _c (m/min)								
Cutting material carbide									
UHM 20	–	–	50–220	–	–	30–110	–	–	–
UHM 20 HX	–	–	60–350	–	–	50–180	–	–	–
UHM 20 TX+	–	–	–	–	–	–	–	–	15–40

390
UTILIS multidec®
 swiss type tools

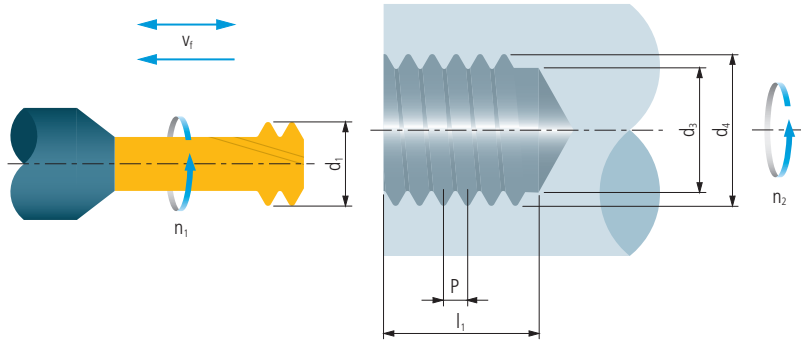

$$v_f = z \cdot f_z \cdot n_1$$

$$n_1 = \frac{v_c \cdot 1000}{\pi \cdot d_1}$$

$$n_2 = \frac{v_f}{\pi \cdot d_1}$$

Explanation

- v_f Feed (mm/min)
- d_1 Tool diameter (mm)
- n_1 Tool revolutions (rev/min)
- d_4 Work piece diameter (mm)
- n_2 Revolutions (rev/min)
- v_c Cutting speed (m/min)
- P Pitch (mm)
- l_1 Length of one milling pass (mm)
- z Number of teeth
- d_3 Drilling diameter (mm)
- f_z Feed per tooth (mm)

Determine the drilling diameter

For the preparation of drilling before thread whirling, it is necessary to know at first the tolerance of the desired thread. To avoid overload of the tool the diameter must not exceed the max. diameter as mentioned in the following table.

Example: M 1.4, pitch 0.3, tolerance desired of the thread 6H on high level (1.11)

Diameter of the hole to be drilled min = 1.11 – (2 × 0.04) 1.03 mm minimum

Engraving is a chip-removing procedure for which ornaments, text and decorations are cut into the material. The removal of the material creates a surface structure which visually stands out against the background. Engravings manufactured in this way have the advantage of greater durability than other procedures.

The product range includes standardised, finished-ground carbide graters which provide extremely good performance in all materials and also pre-ground semifinished products for grinding yourself.



Benefits:

- Standardised tools with point angle of 30° for engraving from 0.2 to 2 mm
- Pre-ground blanks, with lapped chip surface, available for individually grindable tools
- Sharp cutting edges
- Reliable process with long tool life

Overview – multidec®-GRAVER

Technical information 11

Engraving graver

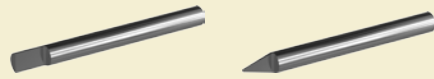

FGA ... 396

FGB ... 396

FGQ ... 397

FGR ... 397

Special tools – multidec4you® 600

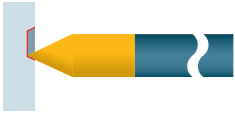

Blank

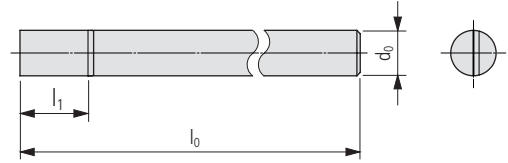
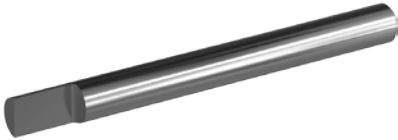

FGA ...

Order designation	Carbide □ 20		Dimensions							
	○	●	l ₁	l ₀	d ₀					
	○	●								
	○	●								
	○	●								
	●	-								
	-	○								
	UHM 20	UHM 20 TX+								
PREMIUM-LINE										
FGA 020 032 ...	■		3	32	2					
FGA 025 032 ...	■		4	32	2.5					
FGA 030 036 ...	■		5	36	3					
FGA 040 042 ...	■		6	42	4					
FGA 050 050 ...	■		8	50	5					
FGA 060 060 ...	■		10	60	6					
FGA 080 060 ...	■		12	60	8					
FGA 100 060 ...	■		15	60	10					

FGB ...

Order designation	Carbide □ 20		Dimensions							
	○	●	l ₁	l ₀	d ₀					
	○	●								
	○	●								
	○	●								
	●	-								
	-	○								
	UHM 20	UHM 20 TX+								
PREMIUM-LINE										
FGB 020 042 ...	■		4	42	2					
FGB 025 042 ...	■		5	42	2.5					
FGB 030 050 ...	■		6	50	3					
FGB 040 060 ...	■		8	60	4					
FGB 050 075 ...	■		10	75	5					
FGB 060 100 ...	■		12	100	6					
FGB 080 100 ...	■		16	100	8					
FGB 100 100 ...	■		20	100	10					

UTILIS
multidec[®]
 swiss type tools

396

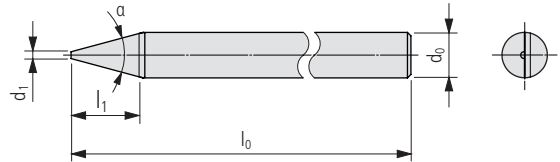
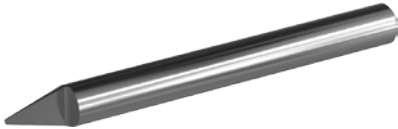
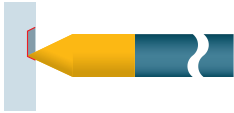

FGQ ...

Order designation	Carbide □ 20		Dimensions							
	UHM 20	UHM 20 TX+	d ₁	α	l ₁	l ₀	d ₀			

PREMIUM-LINE

FGQ 020 032 ...	■	□	0.2	30°	3	32	2				
FGQ 025 032 ...	■	□	0.4	30°	4	32	2.5				
FGQ 030 036 ...	■	□	0.5	30°	5	36	3				
FGQ 040 042 ...	■	□	0.6	30°	6	42	4				
FGQ 050 050 ...	■	□	0.8	30°	8	50	5				
FGQ 060 060 ...	■	□	1	30°	10	60	6				
FGQ 080 060 ...	■	□	1.5	30°	12	60	8				
FGQ 100 060 ...	■	□	2	30°	15	60	10				

FGR ...

Order designation	Carbide □ 20		Dimensions							
	UHM 20	UHM 20 TX+	d ₁	α	l ₁	l ₀	d ₀			

PREMIUM-LINE

FGR 020 042 ...	■	□	0.2	30°	4	42	2				
FGR 025 042 ...	■	□	0.4	30°	5	42	2.5				
FGR 030 050 ...	■	□	0.5	30°	6	50	3				
FGR 040 060 ...	■	□	0.6	30°	8	60	4				
FGR 050 075 ...	■	□	0.8	30°	10	75	5				
FGR 060 100 ...	■	□	1	30°	12	100	6				
FGR 080 100 ...	■	□	1.5	30°	16	100	8				
FGR 100 100 ...	■	□	2	30°	20	100	10				

multidec®-WHIRLING is a multiple cutter thread whirling tool system designed to significantly improve productivity – essential in today's mass production. Unlike single point threading which requires multiple passes, thread whirling produces a finished thread free from burr in a single pass. The use of up to 12 cutting inserts greatly reduces machining time. For optimized use, UTILIS supplies variants for specific machines with different cutting diameters and lengths.







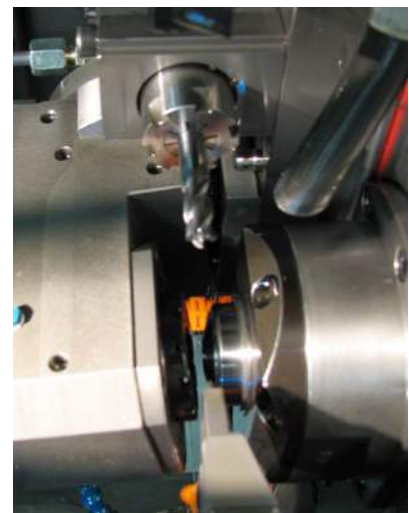

The inserts used in multidec®-WHIRLING are based on those in multidec®-CUT. This groove/lathe tool system is ideal for Swiss type turning machines with a maximum bar passage diameter of 10 mm. The inserts have two cutting edges that are screwed onto the holders with a repeat accuracy of <math>< 0.01\text{ mm}</math>.

Specialities and advantage:

- Up to 12 inserts increase productivity and reduce vibration considerably
- Little concentricity tolerance and high exchange accuracy of inserts $< \pm 0.005\text{ mm}$ guarantee threads of high-quality
- Quick and simple change of the Whirling tool reduces set up time
- Threads without cutting ridge decrease re-machining of parts
- Using UTILIS standard blanks allows short delivery time and best possible coating for demanded application
- Whirling tools with different flight circles and multi start threads available



Overview – multidec®-WHIRLING

Technical information		11																				
Mounting		400																				
Designation system		401																				
Driven toolholder		403																				
Whirling tool		406																				
Inserts		444																				
Whirling box, digital inclinometer and centring device		452																				
Replacement and spare parts		455																				
Usage recommendations and measurement of length difference		456																				
Cutting specification	<table border="1" data-bbox="829 1299 1149 1400"> <thead> <tr> <th></th> <th>Spindel Haupt- und Nebenbohrer</th> <th>Spindelbohrer Haupt- und Nebenbohrer</th> <th>Spindelbohrer Hauptbohrer Hauptbohrer</th> <th>Spindelbohrer Hauptbohrer Hauptbohrer</th> </tr> </thead> <tbody> <tr> <td>Spindelbohrer Haupt- und Nebenbohrer</td> <td>125-200</td> <td>150-250</td> <td>200-250</td> <td>-</td> </tr> <tr> <td>Kategorie Kategorie Kategorie</td> <td>I</td> <td>II</td> <td>III</td> <td>IV</td> </tr> <tr> <td>Spindelbohrer Hauptbohrer Hauptbohrer</td> <td>✓</td> <td>✓</td> <td>✓</td> <td>✓</td> </tr> </tbody> </table>		Spindel Haupt- und Nebenbohrer	Spindelbohrer Haupt- und Nebenbohrer	Spindelbohrer Hauptbohrer Hauptbohrer	Spindelbohrer Hauptbohrer Hauptbohrer	Spindelbohrer Haupt- und Nebenbohrer	125-200	150-250	200-250	-	Kategorie Kategorie Kategorie	I	II	III	IV	Spindelbohrer Hauptbohrer Hauptbohrer	✓	✓	✓	✓	459
	Spindel Haupt- und Nebenbohrer	Spindelbohrer Haupt- und Nebenbohrer	Spindelbohrer Hauptbohrer Hauptbohrer	Spindelbohrer Hauptbohrer Hauptbohrer																		
Spindelbohrer Haupt- und Nebenbohrer	125-200	150-250	200-250	-																		
Kategorie Kategorie Kategorie	I	II	III	IV																		
Spindelbohrer Hauptbohrer Hauptbohrer	✓	✓	✓	✓																		
Order guideline for execution of special thread profiles		462																				
Guidance and troubleshooting		463																				
Special tools – multidec4you®		600																				
Accessories		651																				

MWT... (Type A)



xModular-System

Flexible, two-part system, which reduces set-up time with the fast change whirling ring (the adapter remains in the whirling device); guaranteed concentricity of $\pm 0.005\text{mm}$.

MWT... (Type B)



Mono-system

Highly compact single component system. This enables high concentricity of $\pm 0.005\text{mm}$ to be achieved.

MWT... (Type C)



QuickChange-System

Unlike the xModular-System the whirling ring is removed or inserted by rotation. Here too, the guaranteed concentricity of $\pm 0.005\text{mm}$ is maintained.

MWA...
Adapter

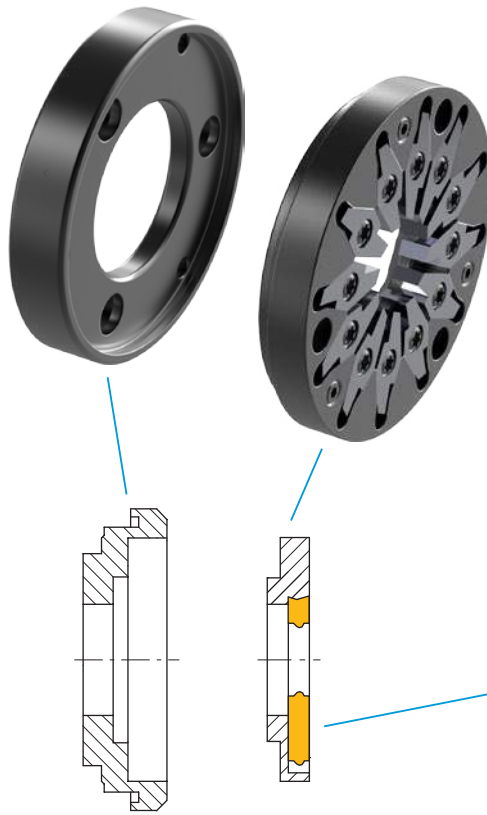

MWR...
Whirling ring

MWI...
Inserts

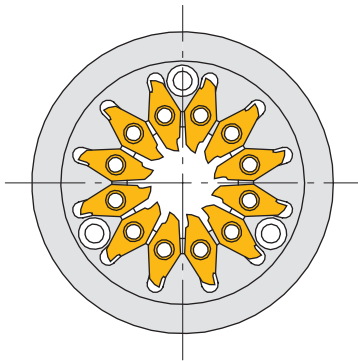

MWT... (HSK...)



MWT... (PSC...)



MWT... (ER...)

The designation of every part includes all important information according to the following system:

Whirling head

MWT12 164 4244 165 12

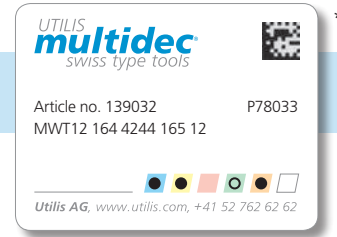
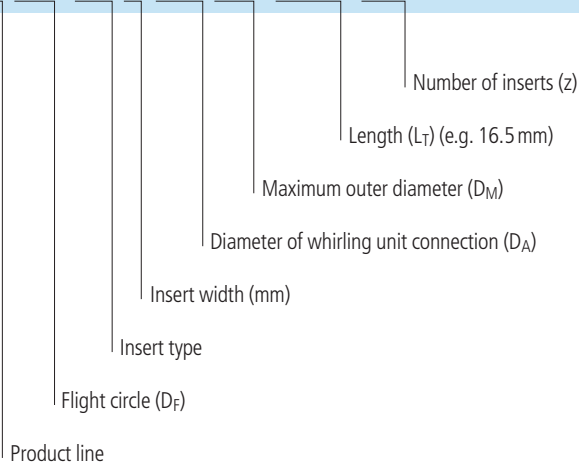

Adapter

MWA 402645 050

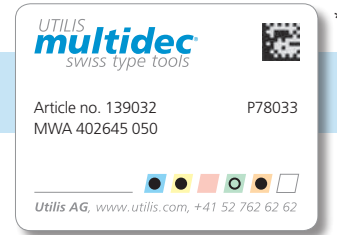
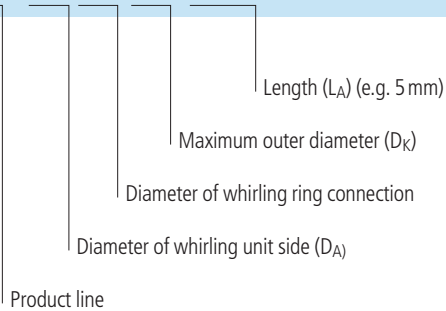

Whirling ring

MWR12 164 2646 080 12

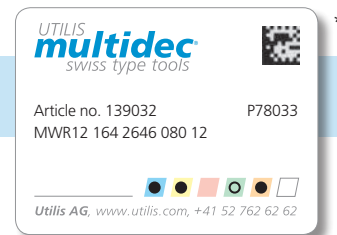
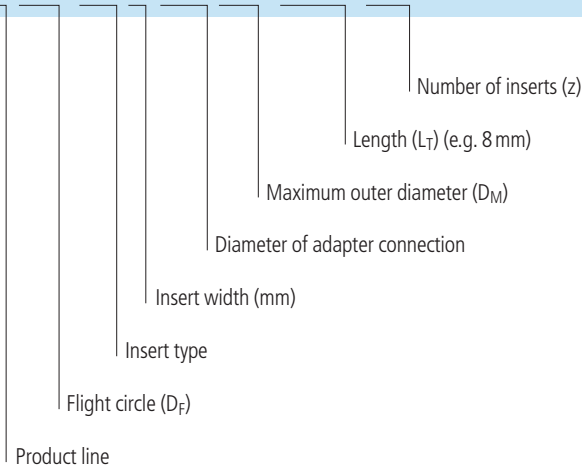

Inserts

MWI12 164 HA3.5 VP UHM10 HX

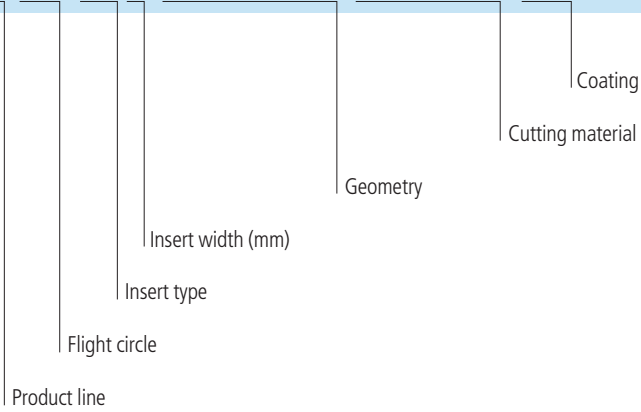

UTILIS **multidec**
swiss type tools



Article no. 139032 P78033
MWI12 164 HA3.5 VP UHM30 HX



Utilis AG, www.utilis.com, +41 52 762 62 62

Special inserts

MWI12 0001 VP UHM10 HX

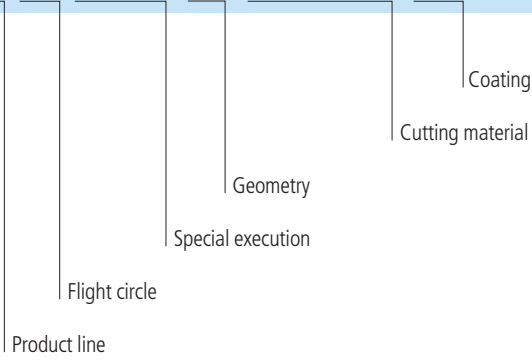

UTILIS **multidec**
swiss type tools



Article no. 139032 P78033
MWI12 0001 VP UHM30 HX



Utilis AG, www.utilis.com, +41 52 762 62 62

402

UTILIS **multidec**
swiss type tools

* Packaging Information 8

Legend 8...

Machine		Driven toolholder			
Manufacturer	Type	Manufacturer	Type		
			A	B	C
			406 ... 432 ... 436 ...		
BENZINGER	TNI	WTO			
CITIZEN	A 20	CITIZEN			
		PCM			
	A 2 20	CITIZEN			
	A 3 20	CITIZEN			
	A 32	CITIZEN			
	A 2 32	CITIZEN			
	C 12	JARVIS			
		JARVIS			
		MADAULA			
	C 16	PCM			
		W & F			
	C 20	PCM			
		CITIZEN			
	C 32	PCM			
		MADAULA			
	K 12	PCM			
		MADAULA			
	K 16	PCM			
		PCM			
	L 12 VII	PCM			
	L 12	PCM			
		MADAULA			
	L 16	PCM			
		WTO			
	L 20	CITIZEN			
	L 2 20	CITIZEN			
		CITIZEN			
		JARVIS			
	L 7 20	MADAULA			
		PCM			
		WTO			
		W & F			
		JARVIS			
	L 25	MADAULA			
		PCM			
		CITIZEN			
	L 32	JARVIS			
		MADAULA			
		PCM			
	M 12	JARVIS			
		MADAULA			
		PCM			
		JARVIS			
	M 16	MADAULA			
		PCM			
	PCM				
M 4 16	CITIZEN				
M 3 20	CITIZEN				
M 4 20	CITIZEN				
	JARVIS				
M 20	MADAULA				
	MT				
	PCM				
M 3 32	CITIZEN				
M 4 32	CITIZEN				
	JARVIS				
	MADAULA				
M 32	MT				
	PCM				
DAESUNG NOMURA	NN 20	WTO			

Machine		Driven toolholder			
Manufacturer	Type	Manufacturer	Type		
			A	B	C
			406 ... 432 ... 436 ...		
DMG MORI	NLX 2500	WTO			
	SPEED 12 7	PCM			
	SPEED 20 8	DMG			
	SPEED 20 11	DMG			
		PCM			
	SPRINT 20 8	DMG			
		MT			
	SPRINT 42 10	DMG			
	BMT 55	WTO			
	PUMA ST 20 G/GS	WTO			
DOOSAN	PUMA ST 20	WTO			
	PUMA ST 26 G/GS	WTO			
	PUMA ST 26	WTO			
	PUMA ST 32 G/GS	WTO			
	PUMA ST 32	WTO			
	PUMA ST 35 G/GS	WTO			
	PUMA ST 35	WTO			
	PUMA TT 1500	WTO			
	PUMA TT 1800 MS	WTO			
	PUMA TT 1800 SY	WTO			
	PUMA TT MS	WTO			
	PUMA TT SY	WTO			
	PUMA TT	WTO			
	BMT 45	WTO			
	BMT 55	WTO			
EMCO	Hyperturn 65	WTO			
	Maxturn 65	WTO			
GANESH	SL 20	WTO			
GOODWAY	SW 20	WTO			
	SW 32	WTO			
	SW 42	WTO			
HANWHA	STL 32	MADAULA			
		WTO			
	STL 35	MADAULA			
		WTO			
	STL 38	MADAULA			
		WTO			
	STL 45	WTO			
	XD 12	MADAULA			
		WTO			
	XD 16	MADAULA			
		WTO			
	XD 20	MADAULA			
		WTO			
		W & F			
	XD 26	MADAULA			
	WTO				
XD 32	ALPSTOOL				
	WTO				
XD 35	WTO				
XD 38	WTO				
XDI 20	WTO				
XE 20	WTO				
XE 26	WTO				
HASEGAWA	JS 1 W	HASEGAWA			
JINN FA	JSL 20	JINN FA			
LEISTRITZ	LWN 90	LEISTRITZ			
MAIER	BASIC ML 20	MAIER			

Machine		Driven toolholder			
Manufacturer	Type	Manufacturer	Type		
			A	B	C
			□ 406 ...	□ 432 ...	□ 436 ...
MANURHIN	KMK 426	WTO		■	
	KMK 432	WTO		■	
	KMK 526	WTO		■	
	KMK 532	WTO		■	
	KMK 626	WTO		■	
	KMK 632	WTO		■	
MAZAK	QTN 200 MS	WTO		■	
	QTN 200 MSY	WTO		■	
	QTN 200 M	WTO		■	
	QTN 200 MY	WTO		■	
	QTN 200	WTO		■	
	QTN 250 MS	WTO		■	
	QTN 250 MSY	WTO		■	
	QTN 250 M	WTO		■	
	QTN 250 MY	WTO		■	
	QTN 250	WTO		■	
	SQ 200 M	WTO		■	
	SQ 200	WTO		■	
	SQ 250 M	WTO		■	
	SQ 250	WTO		■	
	SQT 200 MS	WTO		■	
	SQT 200 MSY	WTO		■	
	SQT 200 M	WTO		■	
	SQT 200 MY	WTO		■	
	SQT 200	WTO		■	
	SQT 250 MS	WTO		■	
SQT 250 MSY	WTO		■		
SQT 250 M	WTO		■		
SQT 250 MY	WTO		■		
SQT 250	WTO		■		
MONNIER+ZAHNER	M 600	MONNIER+ZAHNER	■		
	M 621	MONNIER+ZAHNER	■		
NEXTURN	SA 20	PCM	■		
		WTO		■	
	SA 26	WTO		■	
		PCM	■		
SA 32	WTO		■		
	PCM	■			
NOMURA	NN 16	PCM	■		
		MT	■		
		PCM	■		
	NN 20 UB 8	WTO		■	
NN 32 YB 2	MT	■			

Machine		Driven toolholder			
Manufacturer	Type	Manufacturer	Type		
			A	B	C
			□ 406 ...	□ 432 ...	□ 436 ...
STAR	ECAS 12	AERPIZ		■	
		MADAULA	■		
		STAR	■		
		WTO		■	
	ECAS 20	MADAULA	■		
		PCM		■	
		STAR	■		
		SU-matic	■		
	ECAS 32	WTO	■	■	
		STAR	■		
	SB 12	WTO	■		
		STAR	■		
	SB 16	WTO		■	
		STAR	■		
	SB 20	PCH	■		
		STAR	■		
		WTO		■	
	SR 10	MADAULA	■		
		PCM			■
		STAR	■		
		SU-matic	■		
	SR 16	MADAULA	■		
		STAR	■		
		SU-matic	■		
	SR 20	WTO		■	
		alpha ant	■		
		MADAULA	■		
		PCM	■		
	SR 32	STAR	■		
		SU-matic	■		
		WTO		■	
		MADAULA	■		
SR 38	STAR	■			
	WTO	■			
ST 20	STAR	■			
	WTO	■	■		
ST 38	WTO	■	■		
	STAR	■			
SV 12	MADAULA	■			
	STAR	■			
	WTO	■	■		
SV 20	MADAULA	■			
	PCM	■			
	STAR	■			
SV 32	WTO	■	■		
	MADAULA	■			
SV 38	STAR	■			
	WTO	■	■		
SW 12 R II	PCM			■	
	STAR	■			
SW 12	WTO		■		
	STAR	■			
	WTO		■		
TAKISAWA	TCY 160	WTO		■	
	TCY 200	WTO		■	

Machine		Driven toolholder				
Manufacturer	Type	Manufacturer	Type			
			A	B	C	
			406 ...	432 ...	436 ...	
TORNOS	CT 20	W & F		■		
	DECO 7	TORNOS	■			
	DECO 10	PCM	■			
		TORNOS	■			
	DECO 13	W & F	■			
		MADAULA	■			
		PCM	■			
	DECO 16	TORNOS	■		■	
		W & F	■			
	DECO 20	W & F	■			
		ALBERTI UMBERTO	■			
		MADAULA	■			
		PCM	■			
		PIBOMULTI	■			
	DECO 26	TORNOS	■			
		W & F	■			
		MADAULA	■			
		PCM	■			
		PIBOMULTI	■			
	EvoDECO 10	TORNOS	■			
		W & F	■			
	EvoDECO 16	TORNOS	■			
		W & F	■			
	EvoDECO 20	TORNOS	■			■
	EvoDECO 32	TORNOS	■			■
		MADAULA	■			
	Gamma 20/6	TORNOS	■			
		W & F	■			
		W & F	■		■	
	MultiALPHA 6x32	TORNOS	■			
	MultiALPHA 8x20	TORNOS	■			
	MultiALPHA 8x28	TORNOS	■			
	MultiDECO 20/6	PIBOMULTI	■			
	MultiSIGMA 8x24	TORNOS	■			
MultiSIGMA 8x28	TORNOS	■				
MultiSWISS 6x14	TORNOS	■				
SIGMA 20	MADAULA	■				
	TORNOS	■				
SIGMA 32	TORNOS	■				
SWISS GT 13	TORNOS	■				
SWISS GT 26	TORNOS	■		■		
SWISS ST 26	TORNOS	■				
TRAUB	TNK 36	TRAUB			■	
	TNL 12	TRAUB			■	
	TNL 18	TRAUB			■	
	TNL 26	TRAUB	■		■	
	TNL 32	TRAUB			■	

Machine		Driven toolholder				
Manufacturer	Type	Manufacturer	Type			
			A	B	C	
			406 ...	432 ...	436 ...	
TSUGAMI	B 0265	WTO				
	B 0266	WTO			■	
	B 0325	TSUGAMI	■			
		WTO			■	
	B 0326	TSUGAMI	■			
		WTO			■	
	B 0385	TSUGAMI	■			
		WTO			■	
	BH 20	TSUGAMI	■			
	BH 207	TSUGAMI	■			
	BH 38	TSUGAMI	■			
	HS 207	MADAULA	■			
	NP 16	PCM	■	■		
		MADAULA	■			
	S 205	TSUGAMI	■			
		WTO			■	
	S 206	SONGGIA	■			
		MADAULA	■			
		TSUGAMI	■			
	WTO	WTO			■	
WTO				■		
SS 20	TSUGAMI	■				
SS 26	WTO			■		
	WTO			■		
SS 32	TSUGAMI	■				
	WTO			■		
UTILIS	UTILIS			■		

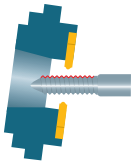

Type A

Attention
Only valid for inserts with 4 mm thickness (ΔL_T)



MWT...

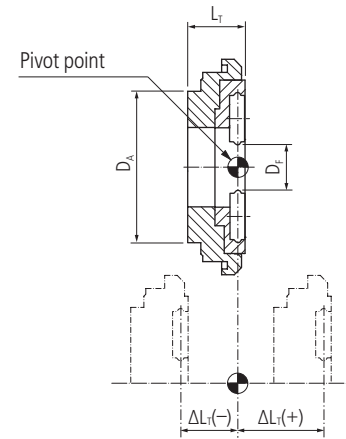

406

Driven toolholder		Whirling tool									
Manufacturer	Type	Order designation	Dimensions								
			D _F	D _A	D _K	D _M	z*	L _A	L _T	ΔL_T	±

PREMIUM-LINE

UTILIS
multidec
swiss type tools

AERPIZ	OM171-00	■	MWT06 164 4040 111 09	■	6	40	40	40	9	4	11.1	0
			MWT06 164 4040 116 09	■	6	40	40	40	9	4.5	11.6	0.4
			MWT12 164 4045 120 09	■	12	40	45	46	9	4	12	0
			MWT12 164 4045 153 09	■	12	40	45	46	9	7.3	15.3	3.3
			MWT12 164 4045 163 09	■	12	40	45	46	9	8.3	16.3	4.3
			MWT12 164 4045 170 09	■	12	40	45	46	9	9	17	5
			MWT12 164 4045 190 09	■	12	40	45	46	9	11	19	7
			MWT12 164 4045 205 09	■	12	40	45	46	9	12.5	20.5	8.5
			MWT12 164 4045 240 09	■	12	40	45	46	9	16	24	12
			MWT12 164 4045 120 12	■	12	40	45	46	12	4	12	0
			MWT12 164 4045 153 12	■	12	40	45	46	12	7.3	15.3	3.3
			MWT12 164 4045 170 12	■	12	40	45	46	12	9	17	5
			MWT12 164 4045 205 12	■	12	40	45	46	12	12.5	20.5	8.5
			MWT12 164 4045 240 12	■	12	40	45	46	12	16	24	12
			MWT15 164 4045 120 09	■	15	40	45	46	9	4	12	0
MWT15 164 4045 190 09	■	15	40	45	46	9	11	19	7			
ALBERTI UMBERTO	ATO.DE.20.0800	■	MWT12 164 4055 103 09	■	12	40	55	55	9	2.3	10.3	0
			MWT12 164 4055 115 09	■	12	40	55	55	9	3.5	11.5	1.2
			MWT12 164 4055 153 09	■	12	40	55	55	9	7.3	15.3	5
			MWT12 164 4055 103 12	■	12	40	55	55	12	2.3	10.3	0
			MWT12 164 4055 115 12	■	12	40	55	55	12	3.5	11.5	1.2
			MWT12 164 4055 153 12	■	12	40	55	55	12	7.3	15.3	5
ALPSTOOL	ZZA08-13000	■	MWT12 164 4546 145 09	■	12	45	45	46	9	6.5	14.5	1
			MWT06 164 4057 105 09	■	6	40	57	46	9	2.5	10.5	0
BECHLER	3281-Y691	■	MWT06 164 4057 155 09	■	6	40	57	46	9	7.5	15.5	5
			MWT06 164 4057 205 09	■	6	40	57	46	9	12.5	20.5	10
			MWT12 164 4057 105 09	■	12	40	57	46	9	2.5	10.5	0
			MWT12 164 4057 175 09	■	12	40	57	46	9	9.5	17.5	7
			MWT12 164 4057 205 09	■	12	40	57	46	9	12.5	20.5	10
			MWT12 164 4057 105 12	■	12	40	57	46	12	2.5	10.5	0
			MWT12 164 4057 175 12	■	12	40	57	46	12	9.5	17.5	7
			MWT12 164 4057 205 12	■	12	40	57	46	12	12.5	20.5	10
			MWT12 164 4057 235 12	■	12	40	57	46	12	12.5	23.5	10
			MWT12 166 4057 235 12	■	12	40	57	46	12	12.5	23.5	10
			MWT15 164 4057 105 09	■	15	40	57	46	9	2.5	10.5	0
			MWT15 164 4057 105 12	■	15	40	57	46	12	2.5	10.5	0
			MWT15 164 4057 175 12	■	15	40	57	46	12	9.5	17.5	7

* z: Number of teeth

Other versions on request

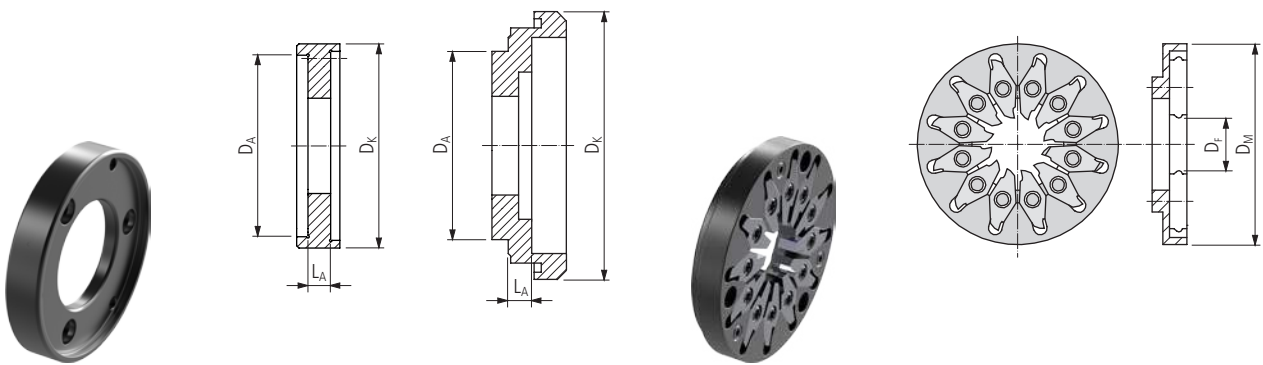

MWA...

MWR...

Adapter	Whirling ring
MWA 402540 040	MWR06 164 2540 091 09
MWA 402540 045	MWR12 164 2540 091 09
MWA 402540 073	MWR12 164 2540 091 12
MWA 402540 083	MWR06 164 2546 080 09
MWA 402540 090	MWR08 164 2546 080 09
MWA 402540 110	MWR12 164 2546 080 09
MWA 402540 125	MWR12 164 2546 080 12
MWA 402540 160	MWR15 164 2546 080 09
MWA 402655 023	MWR06 164 2646 080 09
MWA 402655 035	MWR12 164 2646 080 09
MWA 402655 073	MWR12 164 2646 080 12
MWA452645 065	MWR12 166 2646 090 12
MWA 402657 025	MWR15 164 2646 080 09
MWA 402657 075	
MWA 402657 095	
MWA 402657 125	
MWA 402657 155	

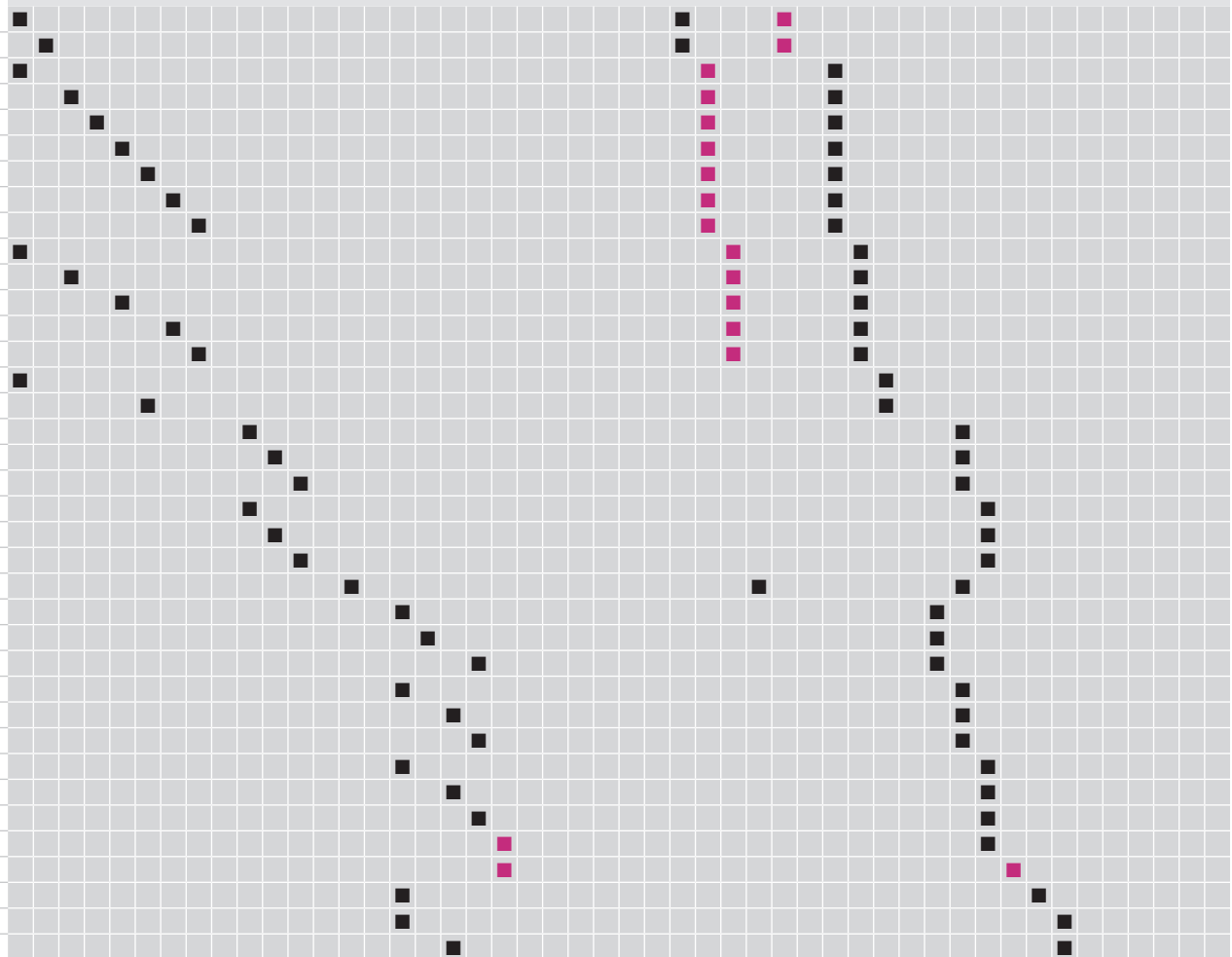

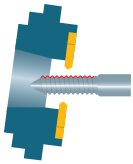

Type A

Attention
Only valid for inserts with 4 mm thickness (ΔL_T)



MWT...

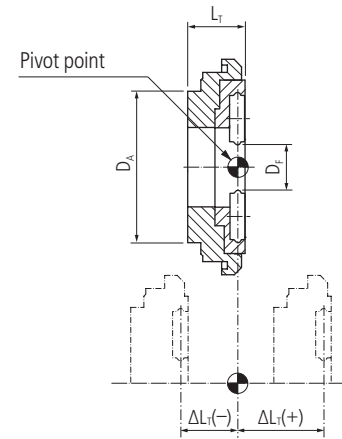

Driven toolholder		Whirling tool										
Manufacturer	Type	Order designation	Dimensions									ΔL_T ±
			D_F	D_A	D_K	D_M	z^*	L_A	L_T			

PREMIUM-LINE

UTILIS
multidec
swiss type tools

BeWell	SMSW - 120 BT	■	MWT08 164 4046 160 09	■	0	0	0	0	0	0	0	0
			MWT12 164 4046 115 09	■	12	40	46	46	9	3.5	11.5	0
			MWT12 164 4046 130 09	■	12	40	46	46	9	5	13	1.5
			MWT12 164 4046 240 09	■	12	40	46	46	9	16	24	12.5
			MWT12 164 4046 280 09	■	12	40	46	46	9	20	28	16.5
			MWT12 164 4046 115 12	■	12	40	46	46	12	3.5	11.5	0
			MWT12 164 4046 130 12	■	12	40	46	46	12	5	13	1.5
			MWT12 164 4046 190 12	■	12	40	46	46	12	11	19	7.5
			MWT12 164 4046 240 12	■	12	40	46	46	12	16	24	12.5
			MWT12 164 4046 280 12	■	12	40	46	46	12	20	28	16.5
			MWT15 164 4046 130 09	■	15	40	46	46	9	5	13	1.5
			MWT15 164 4046 240 09	■	15	40	46	46	9	16	24	12.5
MWT15 164 4046 240 12	■	15	40	46	46	12	16	24	12.5			
DMG	45x15	■	MWT12 164 4046 115 09	■	12	40	46	46	9	3.5	11.5	0
			MWT12 164 4046 115 12	■	12	40	46	46	12	3.5	11.5	0
HASEGAWA	JS-1W	■	MWT12 164 9494 250 09	■	12	94	94	94	9	22.5	25	0
JARVIS	LTR0128	■	MWT12 164 4053 121 09	■	12	40	53	46	9	4.3	12.1	0
	LTR0132	■	MWT12 164 4053 131 09	■	12	40	53	46	9	5.3	13.1	1
	LTR0139	■	MWT12 164 4053 121 12	■	12	40	53	46	12	4.3	12.1	0
	LTR0168	■	MWT12 164 4053 131 12	■	12	40	53	46	12	5.3	13.1	1
	LTR0183	■	MWT15 164 4053 121 09	■	15	40	53	46	9	4.3	12.1	0
JARVIS	CHS-1B6	■										
	LTR0131	■	MWT12 164 3746 121 09	■	12	37	46	46	9	4.1	12.1	0
JARVIS	LTR0169	■	MWT12 164 3746 221 09	■	12	37	46	46	9	14.1	22.1	10
	LTR0170	■	MWT12 164 3746 121 12	■	12	37	46	46	12	4.1	12.1	0
			MWT12 164 3746 221 12	■	12	37	46	46	12	14.1	22.1	10
	CHS-2B6	■	MWT12 166 3746 131 12	■	12	37	46	46	12	4.1	13.1	0
MWT12 166 3746 231 12			■	12	37	46	46	12	4.1	23.1	0	
JINN FA	STR 260100	■	MWT12 164 4244 155 09	■	12	42	42	44	9	7.5	15.5	0
			MWT12 164 4244 155 12	■	12	42	42	44	12	7.5	15.5	0
LEISTRITZ	WR796	■	MWT15 164 4294 250 09	■	15	42	94	94	9	22	25	0
	WR 926	■	MWT25 164 152170 200 12	■	25	152	170	58	12	10	20	-

* z: Number of teeth

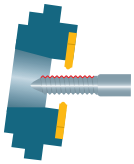

Type A

Attention

Only valid for inserts with 4 mm thickness (ΔL_T)



MWT...

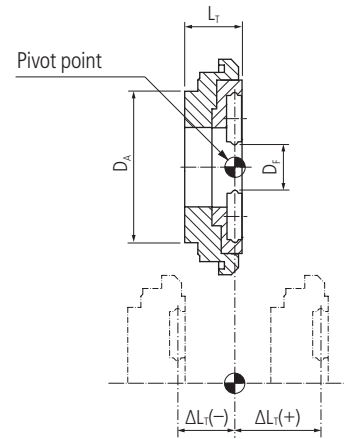

410

Driven toolholder		Whirling tool										
Manufacturer	Type	Order designation	Dimensions									ΔL_T ±
			D_F	D_A	D_K	D_M	z^*	L_A	L_T			

PREMIUM-LINE

UTILIS **multidec**®
swiss type tools

MADAULA	1110.00055 CZ.035.M12/M16 CZ.035.M12/M16T CZ.035.M12/M16T-15 CZ.035.M20/M32T CZ.035.M20/M32T P.035.00063	■	MWT08 164 4046 160 09	0	0	0	0	0	0	0	0	0
		■	MWT12 164 4046 115 09	12	40	46	46	9	3.5	11.5	0	
		■	MWT12 164 4046 130 09	12	40	46	46	9	5	13	1.5	
		■	MWT12 164 4046 240 09	12	40	46	46	9	16	24	12.5	
		■	MWT12 164 4046 280 09	12	40	46	46	9	20	28	16.5	
		■	MWT12 164 4046 115 12	12	40	46	46	12	3.5	11.5	0	
		■	MWT12 164 4046 130 12	12	40	46	46	12	5	13	1.5	
		■	MWT12 164 4046 190 12	12	40	46	46	12	11	19	7.5	
		■	MWT12 164 4046 240 12	12	40	46	46	12	16	24	12.5	
		■	MWT12 164 4046 280 12	12	40	46	46	12	20	28	16.5	
	1110.00065 9999.00444 CZ.035.L16/L20 CZ.035.L20N-15 CZ.035.L20X-15 CZ.035.L25/L35 DE.035.13/15 HW.035.XD2-15 P.035.00002 P.035.00004 P.035.00010 P.035.00014 P.035.00023 P.035.00062 P.035.00066 P.035.00067 P.035.00122 TS.035.S205-15	■	MWT15 164 4046 130 09	15	40	46	46	9	5	13	1.5	
		■	MWT15 164 4046 240 09	15	40	46	46	9	16	24	12.5	
		■	MWT15 164 4046 240 12	15	40	46	46	12	16	24	12.5	
		■	MWT12 164 4055 103 09	12	40	55	55	9	2.3	10.3	0	
		■	MWT12 164 4055 115 09	12	40	55	55	9	3.5	11.5	1.2	
		■	MWT12 164 4055 153 09	12	40	55	55	9	7.3	15.3	5	
		■	MWT12 164 4055 103 12	12	40	55	55	12	2.3	10.3	0	
		■	MWT12 164 4055 115 12	12	40	55	55	12	3.5	11.5	1.2	
		■	MWT12 164 4055 153 12	12	40	55	55	12	7.3	15.3	5	
		■										

* z: Number of teeth

Continuation

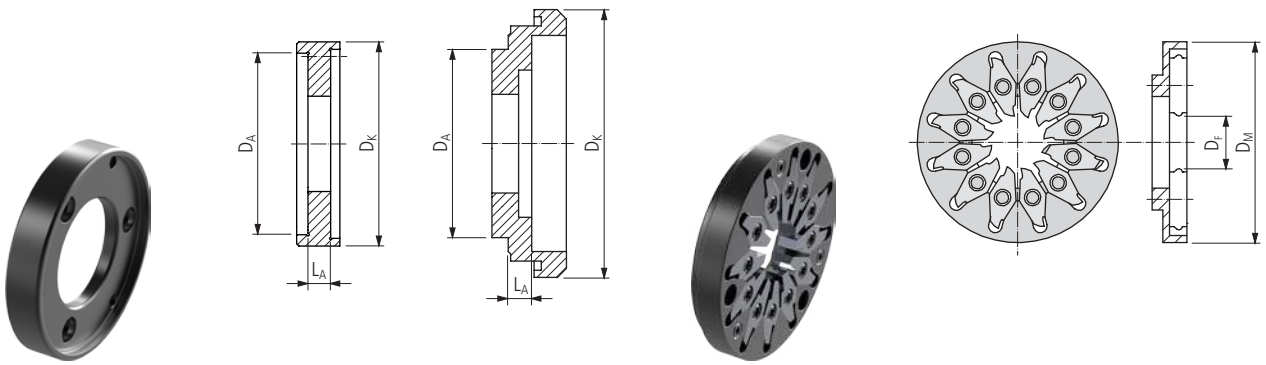

MWA...

MWR...

Adapter										Whirling ring										
MWA 404245 035	MWA 404245 050	MWA 404245 080	MWA 404245 110	MWA 404245 160	MWA 404245 200	MWA 402655 023	MWA 402655 035	MWA 402655 073		MWR12 164 2646 080 09	MWR12 164 2646 080 12	MWR08 164 4246 055 09	MWR12 164 4246 055 09	MWR12 164 4246 055 12	MWR15 164 4246 055 09	MWR15 164 4246 055 12				

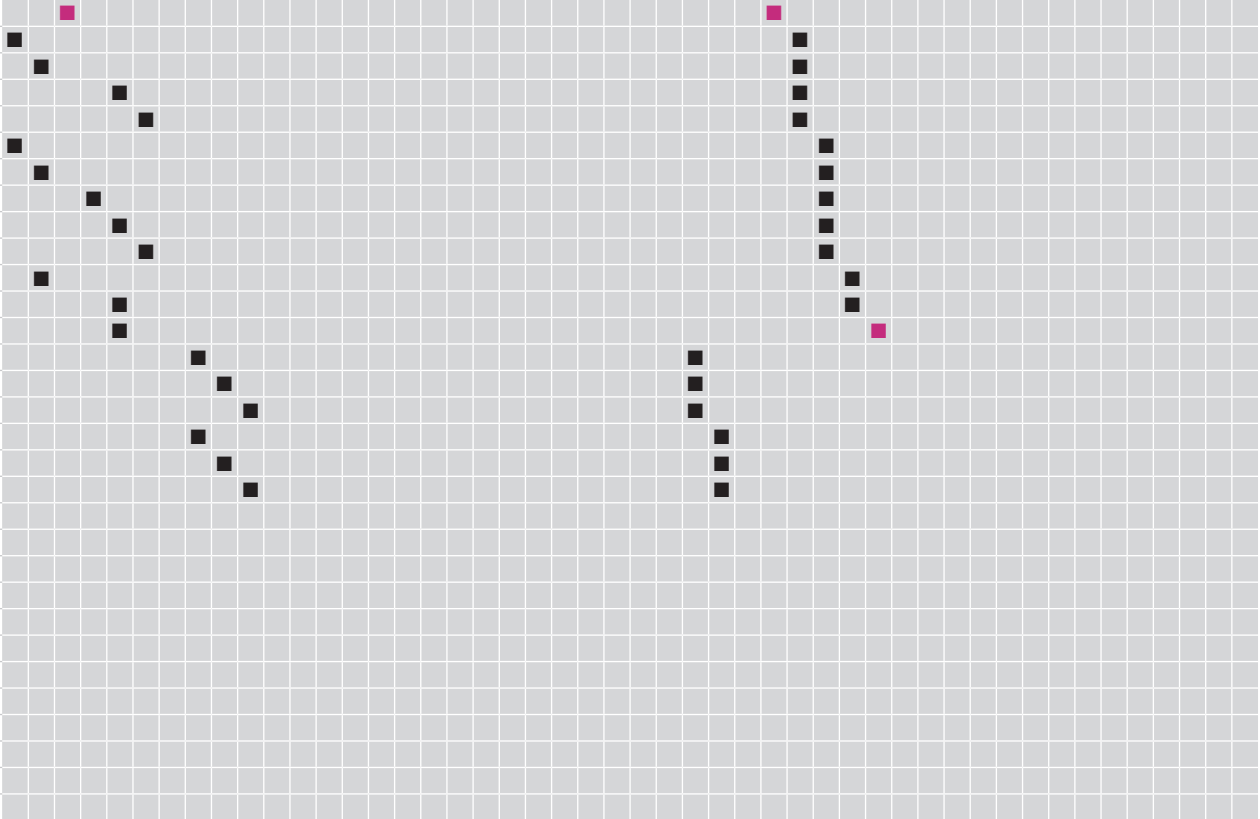

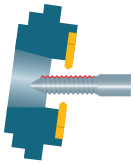

Type A

Attention
Only valid for inserts with 4 mm thickness (ΔL_T)



MWT...

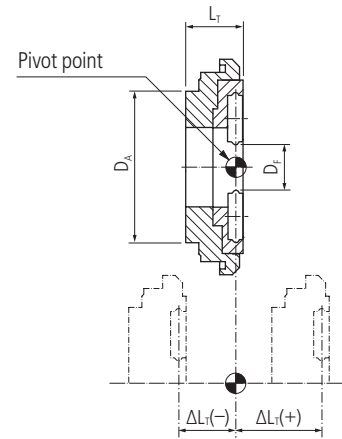

Driven toolholder		Whirling tool									
Manufacturer	Type	Order designation	Dimensions								
			D _F	D _A	D _K	D _M	z*	L _A	L _T	ΔL _T ±	

PREMIUM-LINE

UTILIS
multidec
swiss type tools

MADAULA	CZ.035.C16	■	MWT12 164 3546 169 03	■	12	35	46	46	3	8.9	16.9	0
			MWT12 164 3546 169 09	■	12	35	46	46	9	8.9	16.9	0
			MWT12 164 3546 219 09	■	12	35	46	46	9	13.9	21.9	5
			MWT12 164 3546 169 12	■	12	35	46	46	12	8.9	16.9	0
	DE.035.S20	■	MWT12 164 4548 145 09	■	12	45	48	48	9	6.5	14.5	0
	HW.035.STL	■	MWT12 164 4548 240 09	■	12	45	48	48	9	16	24	9.5
	HW.035.XD2	■	MWT12 164 4548 145 12	■	12	45	48	48	12	6.5	14.5	0
	P.035.00010	■	MWT12 164 4548 240 12	■	12	45	48	48	12	16	24	9.5
	P.035.00014	■	MWT15 164 4548 145 09	■	15	45	48	48	9	6.5	14.5	0
			MWT15 164 4548 145 12	■	15	45	48	48	12	6.5	14.5	0
	P.035.00022	■	MWT12 164 5067 120 09	■	12	50	67	46	9	4	12	0
			MWT12 164 5067 220 09	■	12	50	67	46	9	14	22	10
			MWT12 164 5067 120 12	■	12	50	67	46	12	4	12	0
			MWT12 164 5067 260 12	■	12	50	67	46	12	18	26	14
			MWT15 164 5067 260 09	■	15	50	67	46	9	18	26	14
	P.035.00040	■	MWT12 164 4057 175 09	■	12	40	57	46	9	9.5	17.5	7
	9997.00562	■	MWT12 164 4057 175 12	■	12	40	57	46	12	9.5	17.5	7
	P.035.00049	■	MWT15 164 4057 175 12	■	15	40	57	46	12	9.5	17.5	7
	ST.035.34	■	MWT06 164 4040 111 09	■	6	40	40	40	9	4	11.1	0
	1110.00037	■	MWT06 164 4040 116 09	■	6	40	40	40	9	4.5	11.6	0.4
			MWT12 164 4045 120 09	■	12	40	45	46	9	4	12	0
			MWT12 164 4045 153 09	■	12	40	45	46	9	7.3	15.3	3.3
			MWT12 164 4045 163 09	■	12	40	45	46	9	8.3	16.3	4.3
			MWT12 164 4045 170 09	■	12	40	45	46	9	9	17	5
			MWT12 164 4045 190 09	■	12	40	45	46	9	11	19	7
			MWT12 164 4045 205 09	■	12	40	45	46	9	12.5	20.5	8.5
			MWT12 164 4045 240 09	■	12	40	45	46	9	16	24	12
			MWT12 164 4045 120 12	■	12	40	45	46	12	4	12	0
			MWT12 164 4045 153 12	■	12	40	45	46	12	7.3	15.3	3.3
			MWT12 164 4045 170 12	■	12	40	45	46	12	9	17	5
			MWT12 164 4045 205 12	■	12	40	45	46	12	12.5	20.5	8.5
			MWT12 164 4045 240 12	■	12	40	45	46	12	16	24	12
MWT15 164 4045 120 09			■	15	40	45	46	9	4	12	0	
MWT15 164 4045 190 09			■	15	40	45	46	9	11	19	7	

* z: Number of teeth

Continuation

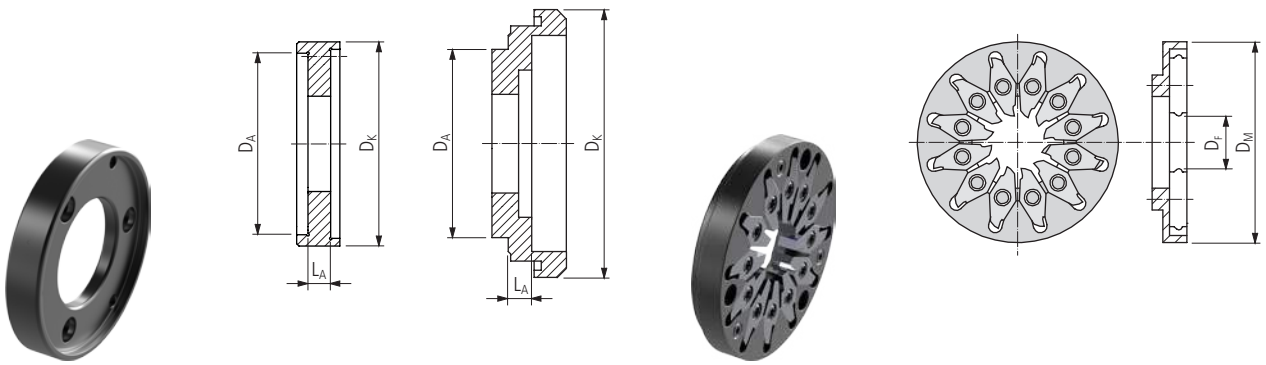

MWA...

MWR...

Adapter										Whirling ring																									
MWA 354246 089	MWA 354246 139	MWA 4226 065	MWA 4226 160	MWA 502667 040	MWA 502667 140	MWA 502667 180	MWA 403657 095	MWA 402540 040	MWA 402540 045	MWA 402540 073	MWA 402540 083	MWA 402540 090	MWA 402540 110	MWA 402540 125	MWA 402540 160	MWR06 164 2540 091 09	MWR12 164 2540 091 09	MWR12 164 2540 091 12	MWR06 164 2546 080 09	MWR12 164 2546 080 09	MWR12 164 2546 080 12	MWR15 164 2546 080 09	MWR12 164 2646 080 09	MWR12 164 2646 080 12	MWR15 164 2646 080 09	MWR12 164 2648 080 09	MWR12 164 2648 080 12	MWR15 164 2648 080 09	MWR15 164 2648 080 12	MWR12 164 3654 080 09	MWR12 164 3654 080 12	MWR15 164 3654 080 12	MWR12 164 4246 055 03	MWR12 164 4246 055 09	MWR12 164 4246 055 12

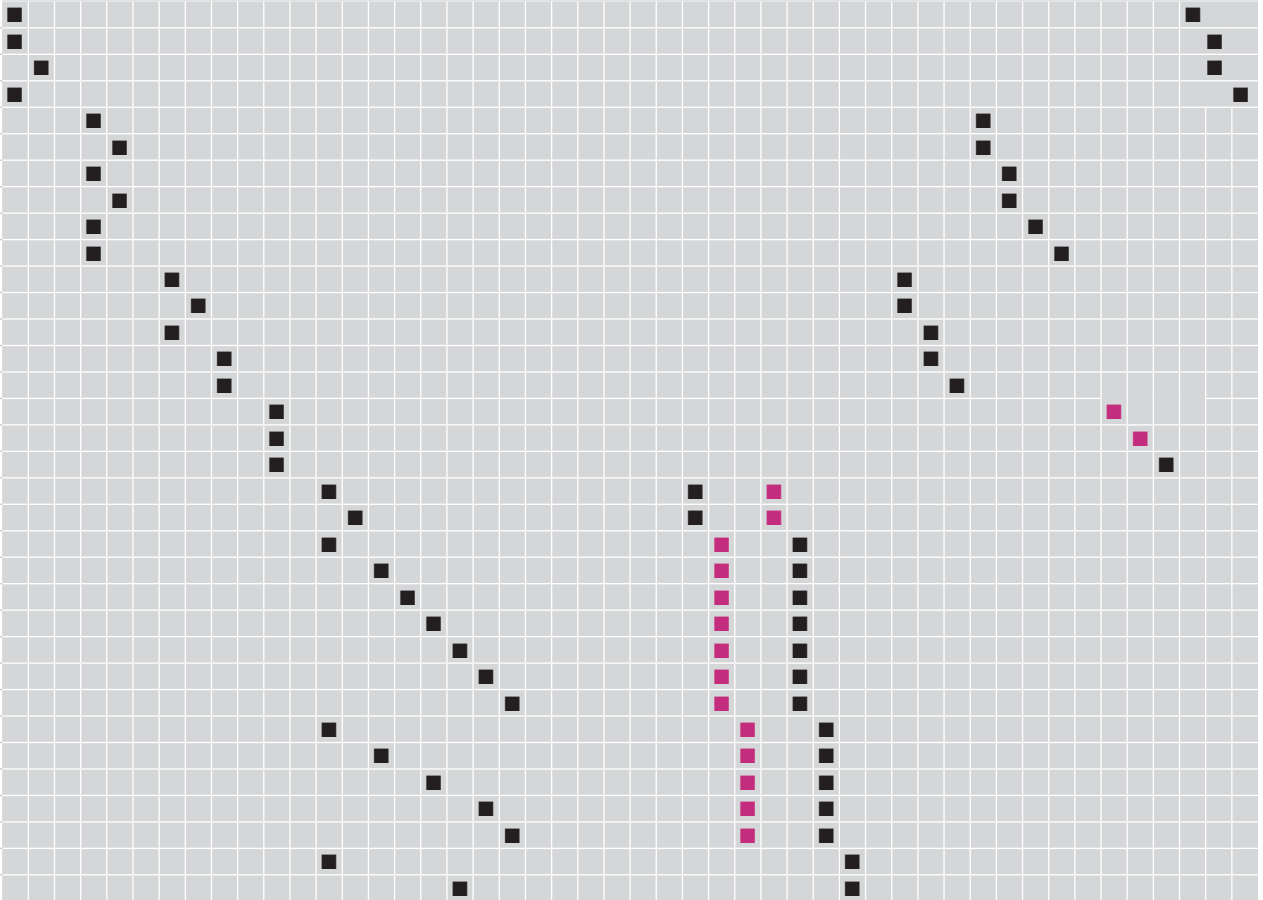

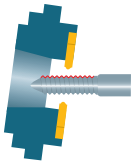

Type A

Attention
Only valid for inserts with 4 mm thickness (ΔL_T)



MWT...

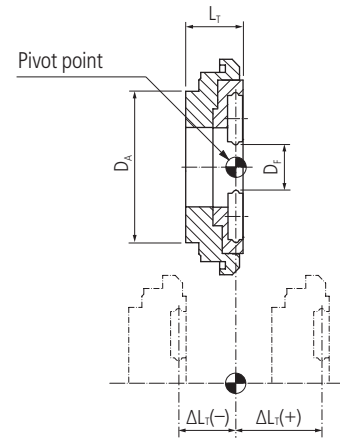

414

Driven toolholder		Whirling tool									
Manufacturer	Type	Order designation	Dimensions								
			D _F	D _A	D _K	D _M	z*	L _A	L _T	ΔL_T ±	

PREMIUM-LINE

MADAULA	P035.00064	■	MWT12 164 4050 135 12	■	12	40	50	46	12	5.5	13.5	0	
	1110.00054	■	MWT12 164 4050 191 12	■	12	40	50	46	12	11.1	19.1	5.6	
MAIER	2-020-W15-2000	■	MWT12 164 4046 240 09	■	12	40	46	46	9	16	24	12.5	
		■	MWT12 164 4046 240 12	■	12	40	46	46	12	16	24	12.5	
	2-020-W35-1001	■	MWT15 164 4046 240 09	■	15	40	46	46	9	16	24	12.5	
		■	MWT15 164 4046 240 12	■	15	40	46	46	12	16	24	12.5	
MONNIER+ZAHNER	N92-00.00	■	MWT06 164 85128 295 09	■	6	85	128	128	9	2.1	29.5	0	
		■	MWT12 164 85128 295 09	■	12	85	128	128	9	2.1	29.5	0	
		■	MWT12 164 85128 295 12	■	12	85	128	128	12	2.1	29.5	0	
		■	MWT15 164 85128 295 12	■	15	85	128	128	12	2.1	29.5	0	
MT	CTZ0040112	■	MWT08 164 4046 160 09	■	0	0	0	0	0	0	0	0	
	NMR0010112	■	MWT12 164 4046 115 09	■	12	40	46	46	9	3.5	11.5	0	
	NMR0070112	■	MWT12 164 4046 130 09	■	12	40	46	46	9	5	13	1.5	
	SPC19210000	■	■	MWT12 164 4046 240 09	■	12	40	46	46	9	16	24	12.5
			■	MWT12 164 4046 280 09	■	12	40	46	46	9	20	28	16.5
			■	MWT12 164 4046 115 12	■	12	40	46	46	12	3.5	11.5	0
			■	MWT12 164 4046 130 12	■	12	40	46	46	12	5	13	1.5
			■	MWT12 164 4046 190 12	■	12	40	46	46	12	11	19	7.5
			■	MWT12 164 4046 240 12	■	12	40	46	46	12	16	24	12.5
			■	MWT12 164 4046 280 12	■	12	40	46	46	12	20	28	16.5
■	MWT15 164 4046 130 09	■	15	40	46	46	9	5	13	1.5			
■	MWT15 164 4046 240 09	■	15	40	46	46	9	16	24	12.5			
■	MWT15 164 4046 240 12	■	15	40	46	46	12	16	24	12.5			

* z: Number of teeth

Continuation

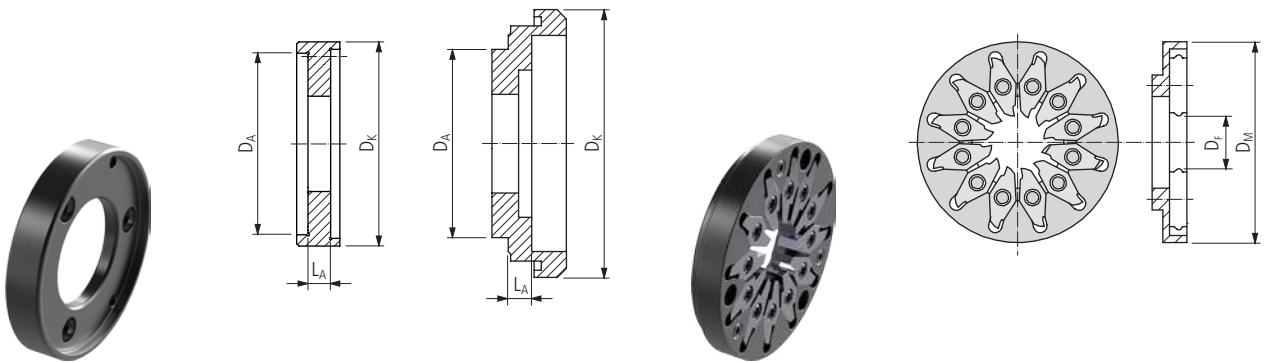

MWA...

MWR...

Adapter										Whirling ring									
MWA 402644 160										MWR06 164 2646 080 09									
MWA 402650 055										MWR12 164 2646 080 09									
MWA 402650 111										MWR12 164 2646 080 12									
MWA 8526128 215										MWR15 164 2646 080 09									
MWA 404245 035										MWR15 164 2646 080 12									
MWA 404245 050										MWR08 164 4246 055 09									
MWA 404245 080										MWR12 164 4246 055 09									
MWA 404245 110										MWR12 164 4246 055 12									
MWA 404245 160										MWR15 164 4246 055 09									
MWA 404245 200										MWR15 164 4246 055 12									

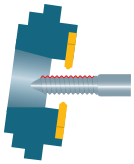

Type A

Attention
Only valid for inserts with 4 mm thickness (ΔL_T)



MWT...

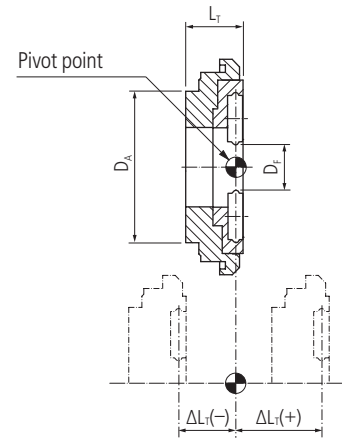

416

Driven toolholder		Whirling tool								
Manufacturer	Type	Order designation	Dimensions							
			D _F	D _A	D _K	D _M	z*	L _A	L _T	ΔL_T
										±

PREMIUM-LINE

UTILIS
multidec
swiss type tools

PCH	HP-681-72	■	MWT06 164 4040 111 09	■	6	40	40	40	9	4	11.1	0
			MWT06 164 4040 116 09	■	6	40	40	40	9	4.5	11.6	0.4
			MWT12 164 4045 120 09	■	12	40	45	46	9	4	12	0
			MWT12 164 4045 153 09	■	12	40	45	46	9	7.3	15.3	3.3
			MWT12 164 4045 163 09	■	12	40	45	46	9	8.3	16.3	4.3
			MWT12 164 4045 170 09	■	12	40	45	46	9	9	17	5
			MWT12 164 4045 190 09	■	12	40	45	46	9	11	19	7
			MWT12 164 4045 205 09	■	12	40	45	46	9	12.5	20.5	8.5
			MWT12 164 4045 240 09	■	12	40	45	46	9	16	24	12
			MWT12 164 4045 120 12	■	12	40	45	46	12	4	12	0
			MWT12 164 4045 153 12	■	12	40	45	46	12	7.3	15.3	3.3
			MWT12 164 4045 170 12	■	12	40	45	46	12	9	17	5
			MWT12 164 4045 205 12	■	12	40	45	46	12	12.5	20.5	8.5
			MWT12 164 4045 240 12	■	12	40	45	46	12	16	24	12
			MWT15 164 4045 120 09	■	15	40	45	46	9	4	12	0
MWT15 164 4045 190 09	■	15	40	45	46	9	11	19	7			
PCM	DE10-W15	■	MWT06 164 4242 115 07	■	6	42	42	42	7	3.5	11.5	0
			MWT06 164 4242 135 07	■	6	42	42	42	7	5.5	13.5	2
			MWT06 164 4242 115 09	■	6	42	42	42	9	3.5	11.5	0
			MWT06 164 4242 135 09	■	6	42	42	42	9	5.5	13.5	2
			MWT06 164 4242 115 07	■	6	42	42	42	7	3.5	11.5	0
			MWT06 164 4242 115 09	■	6	42	42	42	9	3.5	11.5	0
	DE13-W15	■	MWT12 164 4055 103 09	■	12	40	55	55	9	2.3	10.3	0
	DE20-W15	■	MWT12 164 4055 115 09	■	12	40	55	55	9	3.5	11.5	1.2
	GW-TDM-D13	■	MWT12 164 4055 153 09	■	12	40	55	55	9	7.3	15.3	5
	LSW-101	■	MWT12 164 4055 103 12	■	12	40	55	55	12	2.3	10.3	0
	GSW-261-000	■	MWT12 164 4055 115 12	■	12	40	55	55	12	3.5	11.5	1.2
			MWT12 164 4055 153 12	■	12	40	55	55	12	7.3	15.3	5

* z: Number of teeth

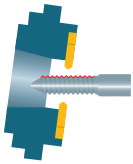

Type A

Attention
Only valid for inserts with 4 mm thickness (ΔL_T)



MWT...

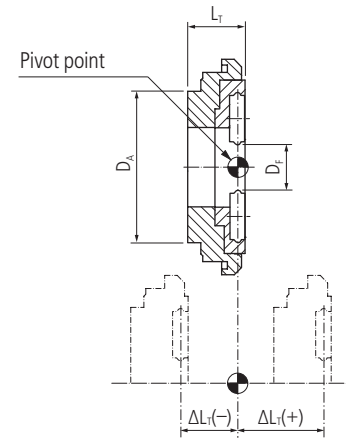

418

Driven toolholder		Whirling tool									
Manufacturer	Type	Order designation	Dimensions								
			D _F	D _A	D _K	D _M	z*	L _A	L _T	ΔL_T ±	

PREMIUM-LINE

UTILIS
multidec
swiss type tools

PCM	DE20-W15-II	■	MWT06 164 4057 105 09	■	6	40	57	46	9	2.5	10.5	0
			MWT06 164 4057 155 09	■	6	40	57	46	9	7.5	15.5	5
			MWT06 164 4057 205 09	■	6	40	57	46	9	12.5	20.5	10
			MWT12 164 4057 105 09	■	12	40	57	46	9	2.5	10.5	0
			MWT12 164 4057 175 09	■	12	40	57	46	9	9.5	17.5	7
			MWT12 164 4057 205 09	■	12	40	57	46	9	12.5	20.5	10
			MWT12 164 4057 105 12	■	12	40	57	46	12	2.5	10.5	0
			MWT12 164 4057 175 12	■	12	40	57	46	12	9.5	17.5	7
			MWT12 164 4057 205 12	■	12	40	57	46	12	12.5	20.5	10
			MWT12 164 4057 235 12	■	12	40	57	46	12	12.5	23.5	10
			MWT12 164 4057 235 12	■	12	40	57	46	12	12.5	23.5	10
			MWT15 164 4057 105 09	■	15	40	57	46	9	2.5	10.5	0
			MWT15 164 4057 105 12	■	15	40	57	46	12	2.5	10.5	0
	MWT15 164 4057 175 12	■	15	40	57	46	12	9.5	17.5	7		
	KSW-101-000	■	MWT08 164 4046 160 09	■	0	0	0	0	0	0	0	0
	LSW-101-L20-000	■	MWT12 164 4046 115 09	■	12	40	46	46	9	3.5	11.5	0
	LSW-215-000	■	MWT12 164 4046 130 09	■	12	40	46	46	9	5	13	1.5
	LSW-424-15	■	MWT12 164 4046 240 09	■	12	40	46	46	9	16	24	12.5
	LSW-424-II	■	MWT12 164 4046 280 09	■	12	40	46	46	9	20	28	16.5
	MSW-101-000	■	MWT12 164 4046 115 12	■	12	40	46	46	12	3.5	11.5	0
NN20-W15	■	MWT12 164 4046 130 12	■	12	40	46	46	12	5	13	1.5	
SPW-1220	■	MWT12 164 4046 190 12	■	12	40	46	46	12	11	19	7.5	
MSW-102	■	MWT12 164 4046 240 12	■	12	40	46	46	12	16	24	12.5	
		MWT12 164 4046 280 12	■	12	40	46	46	12	20	28	16.5	
		MWT15 164 4046 130 09	■	15	40	46	46	9	5	13	1.5	
		MWT15 164 4046 240 09	■	15	40	46	46	9	16	24	12.5	
		MWT15 164 4046 240 12	■	15	40	46	46	12	16	24	12.5	

* z: Number of teeth

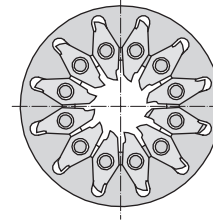
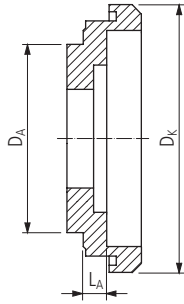
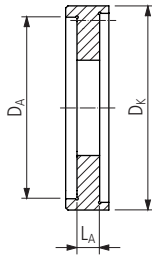

Continuation

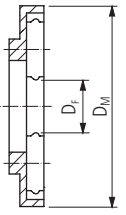

MWA...

MWR...

Adapter										Whirling ring									
MWA 402657 025										MWR06 164 2646 080 09									
MWA 402657 075										MWR12 164 2646 080 09									
MWA 402657 095										MWR12 164 2646 080 12									
MWA 402657 125										MWR12 166 2646 090 12									
MWA 402657 155										MWR15 164 2646 080 09									
										MWR15 164 2646 080 12									
MWA 404245 035										MWR08 164 4246 055 09									
MWA 404245 050										MWR12 164 4246 055 09									
MWA 404245 080										MWR12 164 4246 055 12									
MWA 404245 110										MWR15 164 4246 055 09									
MWA 404245 160										MWR15 164 4246 055 12									
MWA 404245 200																			

■																			
	■																		
		■																	
			■																
				■															
					■														
						■													
							■												
								■											
									■										
										■									
											■								
												■							
													■						
														■					
															■				
																■			
																	■		
																		■	
																			■

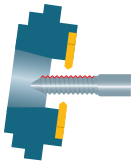

Type A

Attention
Only valid for inserts with 4 mm thickness (ΔL_T)



MWT...

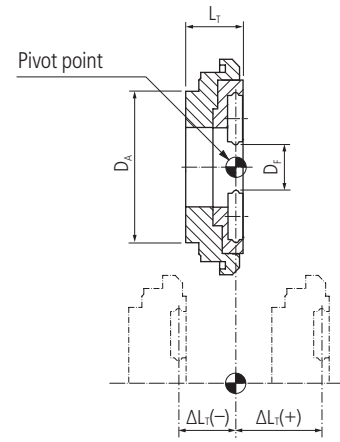

420

Driven toolholder		Whirling tool								
Manufacturer	Type	Order designation	Dimensions						ΔL_T ±	
			D_F	D_A	D_K	D_M	z^*	L_A		L_T

PREMIUM-LINE

UTILIS
multidec
swiss type tools

PCM	GSW-251-PR- 1-A	■	MWT06 164 4040 111 09	■	6	40	40	40	9	4	11.1	0
	SR20J-W20-3D	■	MWT06 164 4040 116 09	■	6	40	40	40	9	4.5	11.6	0.4
			MWT12 164 4045 120 09	■	12	40	45	46	9	4	12	0
			MWT12 164 4045 153 09	■	12	40	45	46	9	7.3	15.3	3.3
			MWT12 164 4045 163 09	■	12	40	45	46	9	8.3	16.3	4.3
			MWT12 164 4045 170 09	■	12	40	45	46	9	9	17	5
			MWT12 164 4045 190 09	■	12	40	45	46	9	11	19	7
			MWT12 164 4045 205 09	■	12	40	45	46	9	12.5	20.5	8.5
			MWT12 164 4045 240 09	■	12	40	45	46	9	16	24	12
			MWT12 164 4045 120 12	■	12	40	45	46	12	4	12	0
			MWT12 164 4045 153 12	■	12	40	45	46	12	7.3	15.3	3.3
			MWT12 164 4045 170 12	■	12	40	45	46	12	9	17	5
			MWT12 164 4045 205 12	■	12	40	45	46	12	12.5	20.5	8.5
			MWT12 164 4045 240 12	■	12	40	45	46	12	16	24	12
			MWT15 164 4045 120 09	■	15	40	45	46	9	4	12	0
	MWT15 164 4045 190 09	■	15	40	45	46	9	11	19	7		
	BSW-215	■	MWT12 164 4046 172 09	■	12	40	45	46	9	9.2	17.2	0
	NESA-32-000	■	MWT12 164 4046 172 12	■	12	40	45	46	12	9.2	17.2	0
			MWT15 164 4046 172 09	■	15	40	45	46	9	9.2	17.2	0
	LSW-420	■	MWT12 164 4546 155 03	■	12	45	45	46	3	10	15.5	0
	LSW-424-000	■	MWT12 164 3546 169 03	■	12	35	46	46	3	8.9	16.9	0
			MWT12 164 3546 169 09	■	12	35	46	46	9	8.9	16.9	0
			MWT12 164 3546 219 09	■	12	35	46	46	9	13.9	21.9	5
	SV20-W15	■	MWT12 164 3546 169 12	■	12	35	46	46	12	8.9	16.9	0
			MWT08 164 4555 130 09	■	8	45	55	46	9	5	13	0
MWT12 164 4555 130 09			■	12	45	55	46	9	5	13	0	
MWT12 164 4555 130 12			■	12	45	55	46	12	5	13	0	
			MWT15 164 4555 130 09	■	15	45	55	46	9	5	13	0

* z: Number of teeth

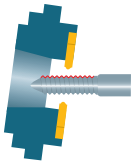

Type A

Attention
Only valid for inserts with 4 mm thickness (ΔL_T)



MWT...

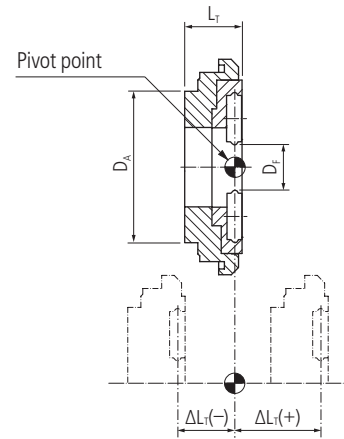

Driven toolholder		Whirling tool									
Manufacturer	Type	Order designation	Dimensions								
			D _F	D _A	D _K	D _M	z*	L _A	L _T	ΔL_T	±

PREMIUM-LINE

UTILIS
multidec
swiss type tools

PIBOMULTI	TOR-D20-TB24-000	■	MWT06 164 4057 105 09	■	6	40	57	46	9	2.5	10.5	0	
			MWT06 164 4057 155 09	■	6	40	57	46	9	7.5	15.5	5	
			MWT06 164 4057 205 09	■	6	40	57	46	9	12.5	20.5	10	
	TOR-D20-TB24-100	■		MWT12 164 4057 105 09	■	12	40	57	46	9	2.5	10.5	0
				MWT12 164 4057 175 09	■	12	40	57	46	9	9.5	17.5	7
				MWT12 164 4057 205 09	■	12	40	57	46	9	12.5	20.5	10
				MWT12 164 4057 105 12	■	12	40	57	46	12	2.5	10.5	0
				MWT12 164 4057 175 12	■	12	40	57	46	12	9.5	17.5	7
				MWT12 164 4057 205 12	■	12	40	57	46	12	12.5	20.5	10
				MWT12 164 4057 235 12	■	12	40	57	46	12	12.5	23.5	10
				MWT12 164 4057 235 12	■	12	40	57	46	12	12.5	23.5	10
				MWT15 164 4057 105 09	■	15	40	57	46	9	2.5	10.5	0
			MWT15 164 4057 105 12	■	15	40	57	46	12	2.5	10.5	0	
	MWT15 164 4057 175 12	■	15	40	57	46	12	9.5	17.5	7			
SONGGIA	TSS260100	■		MWT12 164 4548 145 09	■	12	45	48	48	9	6.5	14.5	0
				MWT12 164 4548 240 09	■	12	45	48	48	9	16	24	9.5
				MWT12 164 4548 145 12	■	12	45	48	48	12	6.5	14.5	0
				MWT12 164 4548 240 12	■	12	45	48	48	12	16	24	9.5
				MWT15 164 4548 145 09	■	15	45	48	48	9	6.5	14.5	0
				MWT15 164 4548 145 12	■	15	45	48	48	12	6.5	14.5	0
STAR	10159-00	■	MWT12 164 3346 165 09	■	12	33	46	46	9	8.5	16.5	0	
	0M171-00	■	MWT12 164 3346 165 12	■	12	33	46	46	12	8.5	16.5	0	
	101-72-00	■	MWT06 164 4040 111 09	■	6	40	40	40	9	4	11.1	0	
	101-72-00	■	MWT06 164 4040 116 09	■	6	40	40	40	9	4.5	11.6	0.4	
	421-73-00	■	MWT12 164 4045 120 09	■	12	40	45	46	9	4	12	0	
	431-72-00	■	MWT12 164 4045 153 09	■	12	40	45	46	9	7.3	15.3	3.3	
	541-78-00	■	MWT12 164 4045 163 09	■	12	40	45	46	9	8.3	16.3	4.3	
	581-71	■	MWT12 164 4045 170 09	■	12	40	45	46	9	9	17	5	
	591-72-00	■	MWT12 164 4045 190 09	■	12	40	45	46	9	11	19	7	
	661-72-00	■	MWT12 164 4045 205 09	■	12	40	45	46	9	12.5	20.5	8.5	
	681-72-00	■	MWT12 164 4045 240 09	■	12	40	45	46	9	16	24	12	
	7.074.191	■	MWT12 164 4045 120 12	■	12	40	45	46	12	4	12	0	
	7.076.225	■	MWT12 164 4045 153 12	■	12	40	45	46	12	7.3	15.3	3.3	
	7.170.882	■		MWT12 164 4045 170 12	■	12	40	45	46	12	9	17	5
				MWT12 164 4045 205 12	■	12	40	45	46	12	12.5	20.5	8.5
			MWT12 164 4045 240 12	■	12	40	45	46	12	16	24	12	
			MWT15 164 4045 120 09	■	15	40	45	46	9	4	12	0	
			MWT15 164 4045 190 09	■	15	40	45	46	9	11	19	7	

* z: Number of teeth

Other versions on request

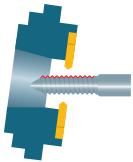

Type A

Attention
Only valid for inserts with 4 mm thickness (ΔL_T)



MWT...

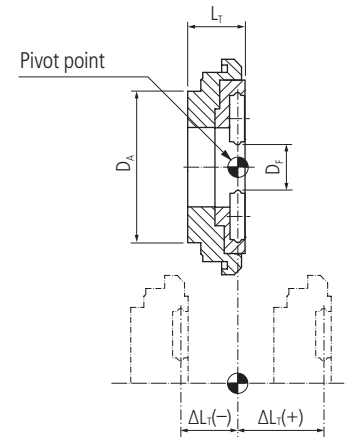

424

Driven toolholder		Whirling tool										
Manufacturer	Type	Order designation	Dimensions									ΔL_T ±
			D_F	D_A	D_K	D_M	z^*	L_A	L_T			

PREMIUM-LINE

STAR	7.073.586	■	MWT12 164 4044 250 09	■	12	40	44	44	9	17	25	11.5
	7.073.590	■	MWT12 164 4044 135 12	■	12	40	44	44	12	5.5	13.5	0
	7.073.670	■	MWT12 164 4044 200 12	■	12	40	44	44	12	12	20	6.5
	7.073.671	■	MWT12 164 4044 250 12	■	12	40	44	44	12	17	25	11.5
	7.073.765	■	MWT15 164 4044 135 12	■	15	40	44	44	12	5.5	13.5	0
SU-matic	AWS 1:1	■	MWT06 164 4040 111 09	■	6	40	40	40	9	4	11.1	0
			MWT06 164 4040 116 09	■	6	40	40	40	9	4.5	11.6	0.4
			MWT12 164 4045 120 09	■	12	40	45	46	9	4	12	0
			MWT12 164 4045 153 09	■	12	40	45	46	9	7.3	15.3	3.3
			MWT12 164 4045 163 09	■	12	40	45	46	9	8.3	16.3	4.3
			MWT12 164 4045 170 09	■	12	40	45	46	9	9	17	5
			MWT12 164 4045 190 09	■	12	40	45	46	9	11	19	7
			MWT12 164 4045 205 09	■	12	40	45	46	9	12.5	20.5	8.5
			MWT12 164 4045 240 09	■	12	40	45	46	9	16	24	12
			MWT12 164 4045 120 12	■	12	40	45	46	12	4	12	0
			MWT12 164 4045 153 12	■	12	40	45	46	12	7.3	15.3	3.3
			MWT12 164 4045 170 12	■	12	40	45	46	12	9	17	5
			MWT12 164 4045 205 12	■	12	40	45	46	12	12.5	20.5	8.5
			MWT12 164 4045 240 12	■	12	40	45	46	12	16	24	12
			MWT15 164 4045 120 09	■	15	40	45	46	9	4	12	0
MWT15 164 4045 190 09	■	15	40	45	46	9	11	19	7			
TORNOS	260448	■	MWT12 164 44M50 120 12	■	12	44	M50	46	12	3	12	0
	305217	■	MWT06 164 4242 115 07	■	6	42	42	42	7	3.5	11.5	0
	305218	■	MWT06 164 4242 135 07	■	6	42	42	42	7	5.5	13.5	2
	217-9510	■	MWT06 164 4242 115 09	■	6	42	42	42	9	3.5	11.5	0
	21-3130	■	MWT06 164 4242 135 09	■	6	42	42	42	9	5.5	13.5	2
	7.172.410	■	MWT06 164 4242 115 07	■	6	42	42	42	7	3.5	11.5	0
		■	MWT06 164 4242 115 09	■	6	42	42	42	9	3.5	11.5	0

* z: Number of teeth

Continuation

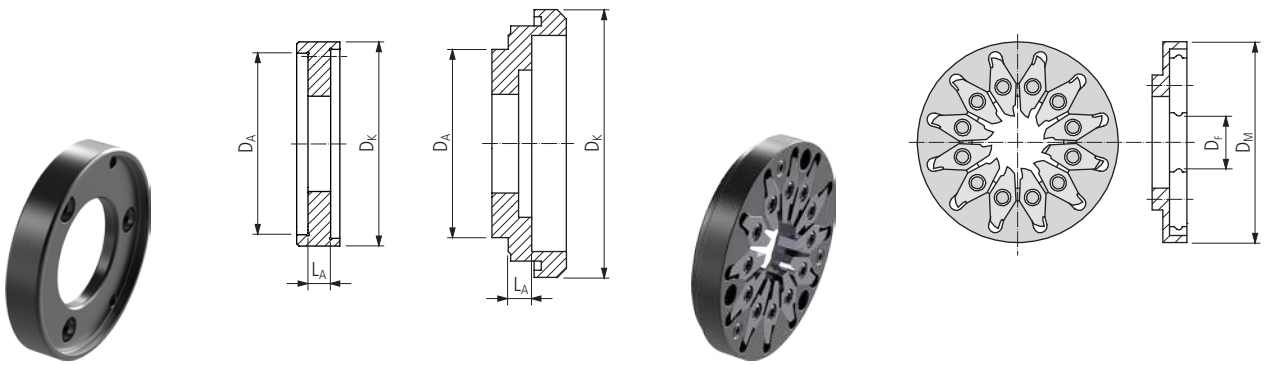

MWA...

MWR...

Adapter										Whirling ring										
MWA 402640 055										MWR06 164 2042 080 07										
MWA 402640 120										MWR06 164 2042 080 09										
MWA 402640 170										MWR06 164 2542 080 07										
MWA 402540 040										MWR06 164 2542 080 09										
MWA 402540 045										MWR06 164 2540 091 09										
MWA 402540 073										MWR12 164 2540 091 12										
MWA 402540 083										MWR06 164 2546 080 09										
MWA 402540 090										MWR12 164 2546 080 09										
MWA 402540 110										MWR12 164 2546 080 12										
MWA 402540 125										MWR15 164 2546 080 09										
MWA 402540 160										MWR12 164 2644 080 09										
MWA 422042 035										MWR12 164 2644 080 12										
MWA 422042 055										MWR15 164 2644 080 12										
MWA 422542 035										MWR12 164 4446 090 12										
MWA 462M50 030																				

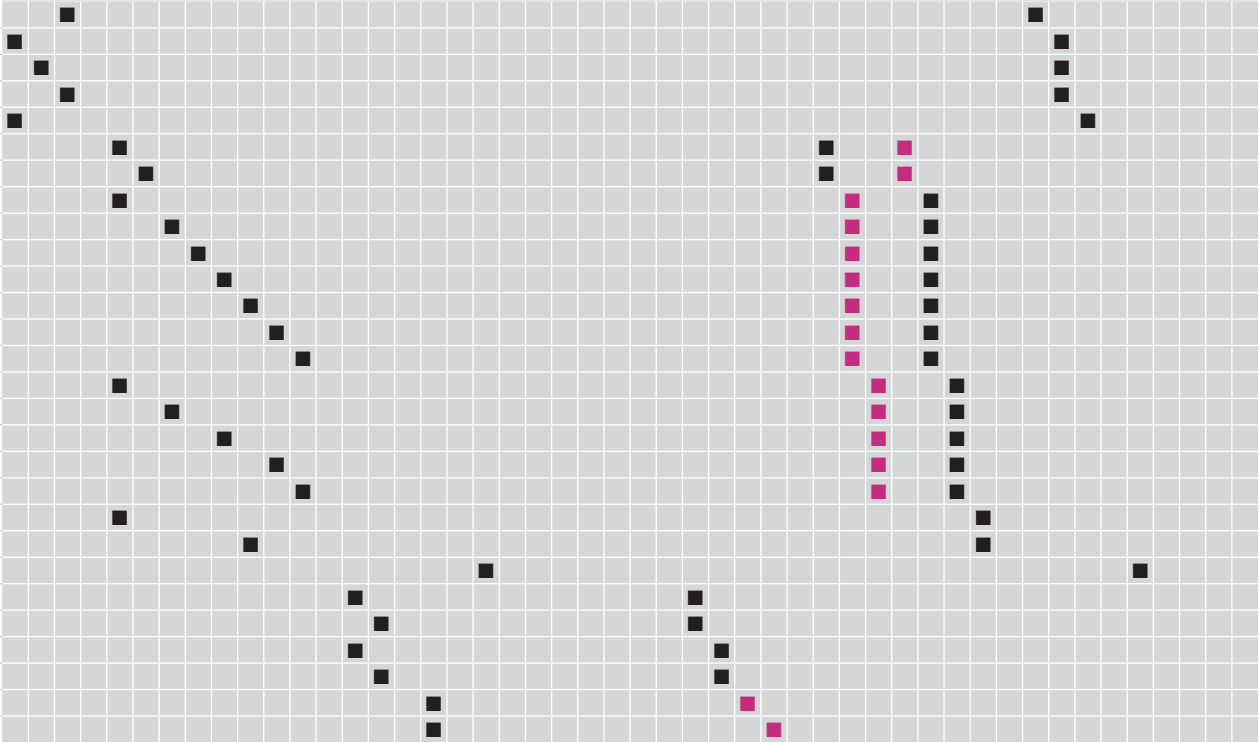

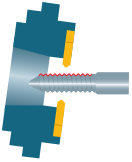

Type A

Attention
Only valid for inserts with 4 mm thickness (ΔL_T)



MWT...

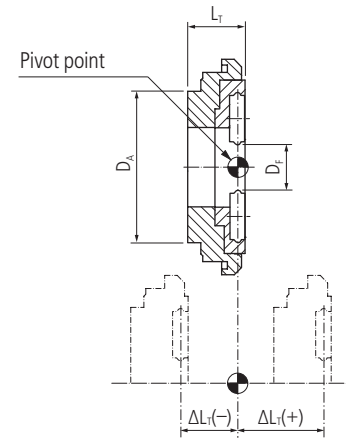

426

Driven toolholder		Whirling tool									
Manufacturer	Type	Order designation	Dimensions								
			D _F	D _A	D _K	D _M	z*	L _A	L _T	ΔL_T ±	

PREMIUM-LINE

TORNOS	226-1900	■	MWT06 164 4057 105 09	■	6	40	57	46	9	2.5	10.5	0	
	199223	■	MWT06 164 4057 155 09	■	6	40	57	46	9	7.5	15.5	5	
	306101	■	MWT06 164 4057 205 09	■	6	40	57	46	9	12.5	20.5	10	
	306432	■	MWT12 164 4057 105 09	■	12	40	57	46	9	2.5	10.5	0	
	307087	■	MWT12 164 4057 175 09	■	12	40	57	46	9	9.5	17.5	7	
	307180	■	MWT12 164 4057 205 09	■	12	40	57	46	9	12.5	20.5	10	
	398541	■	MWT12 164 4057 105 12	■	12	40	57	46	12	2.5	10.5	0	
	418302	■	MWT12 164 4057 175 12	■	12	40	57	46	12	9.5	17.5	7	
	472088	■	MWT12 164 4057 205 12	■	12	40	57	46	12	12.5	20.5	10	
	992381	■	MWT12 164 4057 235 12	■	12	40	57	46	12	12.5	23.5	10	
	1013013	■	MWT12 164 4057 235 12	■	12	40	57	46	12	12.5	23.5	10	
	3281-Y691	■	MWT15 164 4057 105 09	■	15	40	57	46	9	2.5	10.5	0	
	462-2365	■	MWT15 164 4057 105 12	■	15	40	57	46	12	2.5	10.5	0	
	462-2370	■	MWT15 164 4057 175 12	■	15	40	57	46	12	9.5	17.5	7	
	306279 306281 417627 462-2360		■	MWT12 164 5067 120 09	■	12	50	67	46	9	4	12	0
				MWT12 164 5067 220 09	■	12	50	67	46	9	14	22	10
				MWT12 164 5067 120 12	■	12	50	67	46	12	4	12	0
				MWT12 164 5067 260 12	■	12	50	67	46	12	18	26	14
				MWT15 164 5067 260 09	■	15	50	67	46	9	18	26	14
				MWT12 164 4050 105 09	■	12	40	50	50	9	2.5	10.5	0
				MWT12 164 4050 175 09	■	12	40	50	50	9	9.5	17.5	7
				MWT12 164 4050 205 09	■	12	40	50	50	9	12.5	20.5	10
				MWT12 164 4050 105 12	■	12	40	50	50	12	2.5	10.5	0
				MWT12 164 4050 175 12	■	12	40	50	50	12	9.5	17.5	7
				MWT12 164 4050 205 12	■	12	40	50	50	12	12.5	20.5	10
				MWT15 164 4050 105 09	■	15	40	50	50	9	2.5	10.5	0
	MWT15 164 4050 105 12	■	15	40	50	50	12	2.5	10.5	0			

* z: Number of teeth

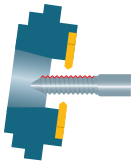

Type A

Attention

Only valid for inserts with 4 mm thickness (ΔL_T)



MWT...

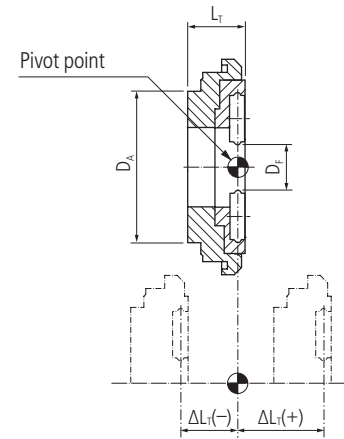

Driven toolholder		Whirling tool										
Manufacturer	Type	Order designation	Dimensions									ΔL_T ±
			D_F	D_A	D_K	D_M	z^*	L_A	L_T			

PREMIUM-LINE

TRAUB	836461	■	MWT12 164 54106 120 09	■	12	54	106	46	9	4	12	0				
	836046	■	MWT12 164 54106 120 12	■	12	54	106	46	12	4	12	0				
			MWT15 164 54106 120 09	■	15	54	106	46	9	4	12	0				
	987510	■	MWT15 164 54106 120 12	■	15	54	106	46	12	4	12	0				
			MWT06 164 2842 179 07	■	6	28	42	42	7	6.9	17.9	0				
	987910	■	MWT06 164 2842 179 09	■	6	28	42	42	9	6.9	17.9	0				
989520	■	MWT06 164 M3442 194 07	■	6	M34	42	42	7	-	19.4	0					
		MWT06 164 M3442 194 09	■	6	M34	42	42	9	-	19.4	0					
TSUGAMI	3268-Y271	■	MWT12 164 5265 166 09	■	12	52	46	65	9	8.7	16.6	0				
	3263-Y480	■	MWT12 164 5265 220 09	■	12	52	46	65	9	14	22	5.3				
	3263-Y481	■	MWT12 164 5265 166 12	■	12	52	46	65	12	8.7	16.6	0				
	3234-Y340	■	MWT12 164 5265 220 12	■	12	52	46	65	12	14	22	5.3				
	3234-Y342 UZ.	■	MWT15 164 5265 220 09	■	15	52	46	65	9	14	22	5.3				
	3234-Y343 GUZ.	■														
3281-Y450	3281-Y451	3268-Y452	3268-Y453	3268-Y454	3268-Y455	■	MWT12 164 5252 160 09	■	12	52	52	46	9	8	16	0
						■	MWT12 164 5252 220 09	■	12	52	52	46	9	14	22	6
						■	MWT12 164 5252 160 12	■	12	52	52	46	12	8	16	0
						■	MWT12 164 5252 190 12	■	12	52	52	46	12	11	19	3
						■	MWT12 164 5252 220 12	■	12	52	52	46	12	14	22	6
						■	MWT15 164 5252 160 09	■	15	52	52	46	9	8	16	0
			■	MWT15 164 5252 220 09	■	15	52	52	46	9	14	22	6			

* z: Number of teeth

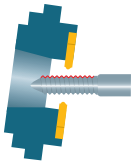

Type A

Attention
Only valid for inserts with 4 mm thickness (ΔL_T)



MWT...

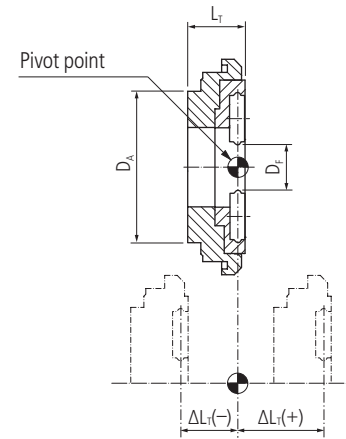

430

Driven toolholder		Whirling tool										
Manufacturer	Type	Order designation	Dimensions									ΔL_T ±
			D_F	D_A	D_K	D_M	z^*	L_A	L_T			

PREMIUM-LINE

UTILIS
multidec
swiss type tools

WTO	419900001-44	■	MWT12 164 4044 250 09	■	12	40	44	44	9	17	25	11.5
	419900001-80	■	MWT12 164 4044 135 12	■	12	40	44	44	12	5.5	13.5	0
	419900002-44	■	MWT12 164 4044 200 12	■	12	40	44	44	12	12	20	6.5
	419900005-44_67969	■	MWT12 164 4044 250 12	■	12	40	44	44	12	17	25	11.5
	TN762002	■	MWT15 164 4044 135 12	■	15	40	44	44	12	5.5	13.5	0
	419900001-44	■	MWT12 164 4046 240 09	■	12	40	46	46	9	16	24	12.5
W & F	419900001-80	■	MWT12 164 4046 240 12	■	12	40	46	46	12	16	24	12.5
			MWT15 164 4046 240 09	■	15	40	46	46	9	16	24	12.5
			MWT15 164 4046 240 12	■	15	40	46	46	12	16	24	12.5
	AG.SPI.Z35.0800.002	■	MWT12 164 4055 103 09	■	12	40	55	55	9	2.3	10.3	0
			MPU.Z35.0800.GA	■	12	40	55	55	9	3.5	11.5	1.2
			MPU.Z35.0800.TS	■	12	40	55	55	9	7.3	15.3	5
	MPU.TO.0800.DE20	■	MWT12 164 4055 103 12	■	12	40	55	55	12	2.3	10.3	0
			MWT12 164 4055 115 12	■	12	40	55	55	12	3.5	11.5	1.2
			MWT12 164 4055 153 12	■	12	40	55	55	12	7.3	15.3	5
	MPU.TO.0800.DE10	■	MWT06 164 4242 115 07	■	6	42	42	42	7	3.5	11.5	0
			MWT06 164 4242 135 07	■	6	42	42	42	7	5.5	13.5	2
			MWT06 164 4242 115 09	■	6	42	42	42	9	3.5	11.5	0
			MWT06 164 4242 135 09	■	6	42	42	42	9	5.5	13.5	2
			MWT06 164 4242 115 07	■	6	42	42	42	7	3.5	11.5	0
			MWT06 164 4242 115 09	■	6	42	42	42	9	3.5	11.5	0
	MPU.TO.0800.DE13	■	MWT06 164 4057 105 09	■	6	40	57	46	9	2.5	10.5	0
			MPU.TO.0800.DE20	■	6	40	57	46	9	7.5	15.5	5
			MPU.TO.0800.DE20S	■	6	40	57	46	9	12.5	20.5	10
MPU.TO.M800.DE20	■	MWT12 164 4057 105 09	■	12	40	57	46	9	2.5	10.5	0	
		MWT12 164 4057 175 09	■	12	40	57	46	9	9.5	17.5	7	
		MWT12 164 4057 205 09	■	12	40	57	46	9	12.5	20.5	10	
		MWT12 164 4057 105 12	■	12	40	57	46	12	2.5	10.5	0	
		MWT12 164 4057 175 12	■	12	40	57	46	12	9.5	17.5	7	
		MWT12 164 4057 205 12	■	12	40	57	46	12	12.5	20.5	10	
		MWT12 164 4057 235 12	■	12	40	57	46	12	12.5	23.5	10	
		MWT12 166 4057 235 12	■	12	40	57	46	12	12.5	23.5	10	
		MWT15 164 4057 105 09	■	15	40	57	46	9	2.5	10.5	0	
		MWT15 164 4057 105 12	■	15	40	57	46	12	2.5	10.5	0	
MWT15 164 4057 175 12	■	15	40	57	46	12	9.5	17.5	7			

* z: Number of teeth

Continuation

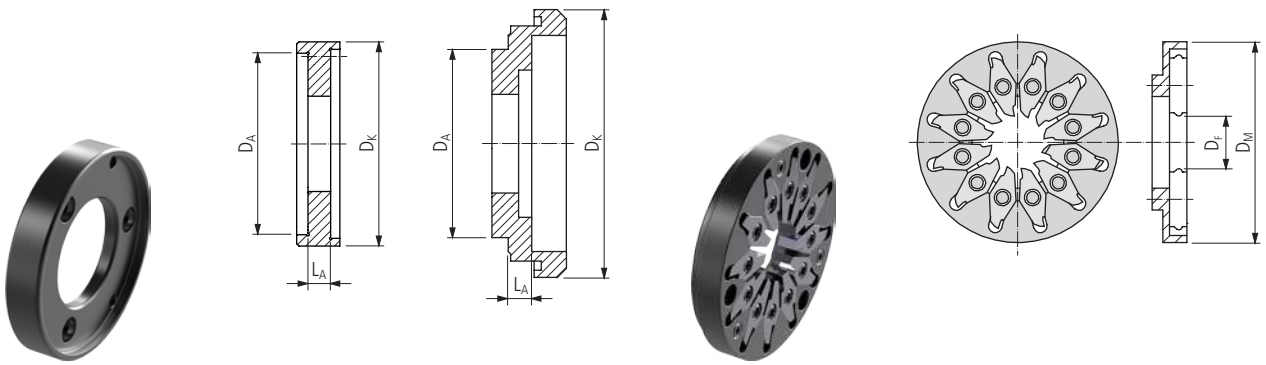

MWA...

MWR...

Adapter										Whirling ring																	
MWA 402644 160	MWA 402640 055	MWA 402640 120	MWA 402640 170	MWA 402655 023	MWA 402655 035	MWA 402655 073	MWA 422042 035	MWA 422042 055	MWA 422542 035	MWA 402657 025	MWA 402657 075	MWA 402657 095	MWA 402657 125	MWA 402657 155	MWR06 164 2042 080 07	MWR06 164 2042 080 09	MWR06 164 2542 080 07	MWR06 164 2542 080 09	MWR12 164 2644 080 09	MWR12 164 2644 080 12	MWR15 164 2644 080 12	MWR06 164 2646 080 09	MWR12 164 2646 080 09	MWR12 164 2646 080 12	MWR12 166 2646 090 12	MWR15 164 2646 080 09	MWR15 164 2646 080 12

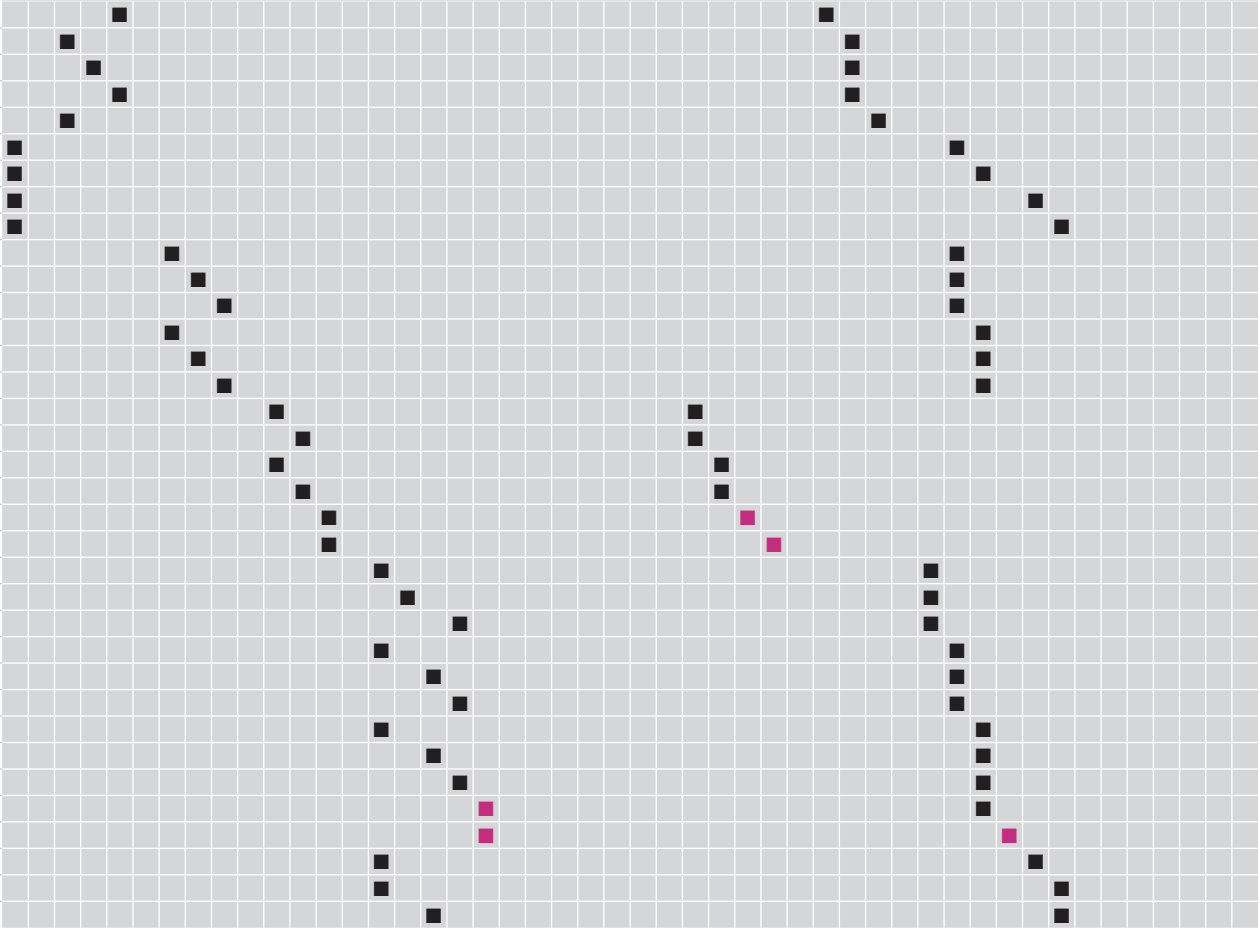

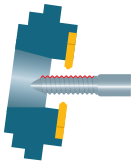

Type B

Attention
Only valid for inserts with 4 mm thickness (ΔL_T)



MWT...

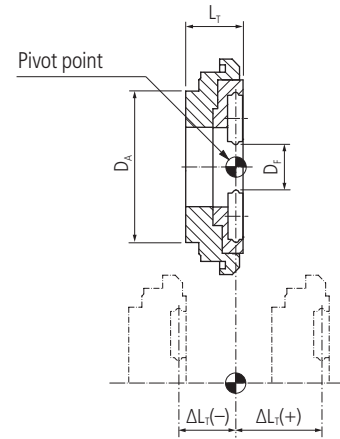

432

Driven toolholder		Whirling tool									
Manufacturer	Type	Order designation	Dimensions								
			D _F	D _A	D _K	D _M	z*	L _A	L _T	ΔL_T	±

PREMIUM-LINE

UTILIS **multidec**®
swiss type tools

CITIZEN	BTW-1000 BTW-2000 BTW-5000 BTW-6000 BTW-3000 BTW-3100 BTW-4000	■	MWT12 164 3347 145 09	■	12	33	47	-	9	-	14.5	0
		■	MWT12 164 3347 145 12	■	12	33	47	-	12	-	14.5	0
		■	MWT12 164 3347 170 09	■	12	33	47	-	9	-	17	7
		■	MWT12 164 3347 170 12	■	12	33	47	-	12	-	17	7
		■	MWT12 166 3347 145 09	■	12	33	47	-	9	-	14.5	0
		■	MWT12 166 3347 145 12	■	12	33	47	-	12	-	14.5	0
		■	MWT12 166 3347 170 09	■	12	33	47	-	9	-	17	7
		■	MWT12 166 3347 170 12	■	12	33	47	-	12	-	17	7
		■	MWT12 168 3347 145 09	■	12	33	47	-	9	-	14.5	0
		■	MWT12 164 2546 070 09	■	12	25	46	-	9	-	7	0
DMG	2123031 2647002 2723028 2858071 2646709	■	MWT12 164 4249 120 09	■	12	42	49	49	9	-	12	0
		■										
		■										
		■										
		■										
		■										
MADAULA	CZ.035.K12/K16 CZ.035.K12/K16-15 CZ.035.M12/M16 CZ.035.M12/M16T-15 CZ.035.M20/M32T CZ.035.M20/M32T P.035.00063 1110.00055	■	MWT06 164 2035 165 07	■	6	20	35	35	7	-	16.5	0
		■	MWT06 164 2035 165 09	■	6	20	35	35	9	-	16.5	0
		■	MWT06 164 2035 225 07	■	6	20	35	35	7	-	22.5	4
		■	MWT06 164 2035 225 09	■	6	20	35	35	9	-	22.5	4
		■	MWT06 164 2035 240 09	■	6	20	35	35	9	-	24	7.5
		■	MWT08 164 2038 185 09	■	8	20	38	38	9	-	18.5	2
		■	MWT08 164 2038 200 09	■	8	20	38	38	9	-	20	3.5
		■	MWT08 164 2038 225 09	■	8	20	38	38	9	-	22.5	4
		■	MWT12 164 4045 100 09	■	12	40	45	-	9	-	10	0
		■	MWT06 164 4253 388 09	■	6	42	53	53	9	-	38.8	0
	P.035.00083	■	MWT06 164 4253 415 09	■	6	42	53	53	9	-	41.5	2.7
		■	MWT06 164 4253 428 09	■	6	42	53	53	9	-	42.8	4
		■	MWT06 164 4253 460 09	■	6	42	53	53	9	-	46	7.2
		■	MWT08 164 4253 388 09	■	8	42	53	53	9	-	38.8	0
MAIER	MAIER MLK	■	MWT06 164 3333 180 07	■	6	33	33	-	7	-	18	0
		■	MWT06 164 3333 180 08	■	6	33	33	-	8	-	18	0
MT	CTZ0040112 NMR0010112 NMR0070112 SPC1921000	■	MWT12 164 4045 100 09	■	12	40	45	-	9	-	10	0
		■										

* z: Number of teeth

Continuation

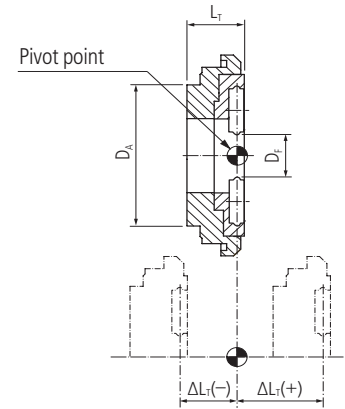

MWT...

Driven toolholder		Whirling tool										
Manufacturer	Type	Order designation	Dimensions									
			D _F	D _A	D _K	D _M	z*	L _A	L _T	ΔL _T ±		
PCM	E20-WI-000	■	MWT06 164 2035 165 07	■	6	20	35	35	7	–	16.5	0
	GSW-101-000	■	MWT06 164 2035 165 09	■	6	20	35	35	9	–	16.5	0
	LSW-515-000	■	MWT06 164 2035 225 07	■	6	20	35	35	7	–	22.5	6
	LSW-515-PR	■	MWT06 164 2035 225 09	■	6	20	35	35	9	–	22.5	6
	KSW-101-000	■	MWT06 164 2035 240 09	■	6	20	35	35	9	–	24	7.5
	LSW-101-L20-000	■	MWT08 164 2038 185 09	■	8	20	38	38	9	–	18.5	2
	LSW-215-000	■	MWT08 164 2038 200 09	■	8	20	38	38	9	–	20	3.5
	LSW-424-15	■	MWT08 164 2038 225 09	■	8	20	38	38	9	–	22.5	4
	MSW-101-000	■										
	NN20-W15	■										
SPW-1220	■											
STAR	7.073.590	■	MWT12 164 4044 100 09	■	12	40	44	–	9	–	10	0
		■	MWT12 164 4044 100 12	■	12	40	44	–	12	–	10	0
	7.074.260 7.079.555	■	MWT12 164 4253 310 09	■	12	42	53	53	9	–	31	0
		■	MWT12 164 4253 335 09	■	12	42	53	53	9	–	33.5	2.5
		■	MWT12 164 4253 385 09	■	12	42	53	53	9	–	38.5	7.5
		■	MWT12 164 4253 405 09	■	12	42	53	53	9	–	40.5	9.5
		■	MWT12 164 4253 310 12	■	12	42	53	53	12	–	31	0
		■	MWT12 164 4253 335 12	■	12	42	53	53	12	–	33.5	2.5
		■	MWT12 164 4253 385 12	■	12	42	53	53	12	–	38.5	7.5
		■	MWT12 164 4253 405 12	■	12	42	53	53	12	–	40.5	9.5
TORNOS	307232	■	MWT06 164 3151 200 07	■	6	31	51	–	7	–	20	0
	386251	■	MWT06 164 3151 200 09	■	6	31	51	–	9	–	20	0
	398856 417165 417174	■										
TRAUB	836461 836046	■	MWT06 164 54106 130 09	■	6	54	106	46	9	5	13	1
		■	MWT12 164 54106 130 09	■	12	54	106	46	9	5	13	1
		■	MWT12 164 54106 130 12	■	12	54	106	46	12	5	13	1
		■	MWT15 164 54106 130 09	■	15	54	106	46	9	5	13	1
		■	MWT15 164 54106 130 12	■	15	54	106	46	12	5	13	1
		■	MWT25 166 54106 140 12	■	25	54	106	–	12	–	14	0

* z: Number of teeth

Continuation

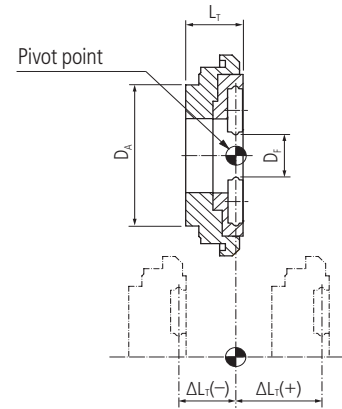

MWT...

Driven toolholder		Whirling tool									
Manufacturer	Type	Order designation	Dimensions								
			D _F	D _A	D _K	D _M	z*	L _A	L _T	ΔL _T ±	

434

UTILIS
multidec
swiss type tools

PREMIUM-LINE

TRAUB	900884 984769 984770 W7045009 W7045012 W7045055 987320	■	MWT12 164 4158 065 12	■	12	41	-	58	12	-	6.5	0	
		■	MWT12 164 4158 080 12	■	12	41	-	58	12	-	8	1.5	
		■	MWT15 164 4158 065 12	■	15	41	-	58	12	-	6.5	0	
		■	MWT25 164 4158 065 09	■	25	41	-	58	9	-	6.5	0	
		■	MWT25 164 4158 080 09	■	25	41	-	58	9	-	8	1.5	
		■	MWT15 164 4158 115 12	■	15	41	-	58	12	-	11.5	5	
		■	MWT06 164 3776 068 09	■	6	37	76	-	9	-	6.8	0	
		■	MWT06 164 3776 078 09	■	6	37	76	-	9	-	7.8	0	
		■	MWT12 164 3776 068 03	■	12	37	76	-	3	-	6.8	0	
		■	MWT12 164 3776 068 09	■	12	37	76	-	9	-	6.8	0	
■	MWT12 164 3776 068 12	■	12	37	76	-	12	-	6.8	0			
TRAUB	989520	■	MWT06 164 M3442 171 09	■	6	M34	42	-	9	-	17.1	-	
WTO	419900000-00, -25, -32, -35, -39, -40, -46, -50, -55 419900001-00, -32, -35 419900002-30, -32, -34, -55 419900003-30, -32, -55 419900004-30, -32 419900005-30, -44 419900006-30 419900007-30, -44 419900008-44 419900009-30 419942000-31, -32, -35, -39, -46, -50 419942000-00, -25, -40, -55 419942001-35 419942001-00, -32 419942002-30, -32, -34 419942002-55 419942003-32 419942003-30, -55 419942004-30, -32 419942005-30, -34, -44 419942006-30 419942007-30, -44 419942008-44 419942009-30 419954004-34 TN762004	■	MWT06 164 4244 165 09	■	6	42	44	44	9	-	16.5	6	
		■	MWT06 164 4244 195 09	■	6	42	44	44	9	-	19.5	9	
		■	MWT12 164 4244 105 09	■	12	42	44	44	9	-	10.5	0	
		■	MWT12 164 4244 105 12	■	12	42	44	44	12	-	10.5	0	
		■	MWT12 164 4244 165 09	■	12	42	44	44	9	-	16.5	6	
		■	MWT12 164 4244 165 12	■	12	42	44	44	12	-	16.5	6	
		■	MWT12 164 4244 205 09	■	12	42	44	44	9	-	20.5	10	
		■	MWT12 164 4244 205 12	■	12	42	44	44	12	-	20.5	10	
		■	MWT12 164 4244 305 09	■	12	42	44	44	9	-	30.5	20	
		■	MWT12 164 4244 305 12	■	12	42	44	44	12	-	30.5	20	
		■	MWT15 164 4244 140 09	■	15	42	44	44	9	-	14	3.5	
		■	MWT15 164 4244 185 09	■	15	42	44	44	9	-	18.5	8	
		■	MWT15 164 4244 205 09	■	15	42	44	44	9	-	20.5	10	
		■	MWT15 164 4244 205 12	■	15	42	44	44	12	-	20.5	10	
		■		■									
		■		■									
		■		■									
		■		■									
		■		■									
		■		■									
		■		■									
		■		■									
■		■											
■		■											
■		■											
■		■											
■		■											
■		■											
■		■											
■		■											

* z: Number of teeth

Other versions on request

Legend □ 8...

Continuation

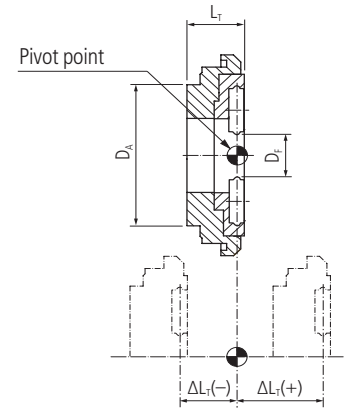

MWT...

Driven toolholder		Whirling tool										
Manufacturer	Type	Order designation	Dimensions									
			D _F	D _A	D _K	D _M	z*	L _A	L _T	ΔL _T		
										±		

PREMIUM-LINE

WTO	419900000-45	■	MWT06 164 5456 125 07	■	6	54	56	56	7	–	12.5	0
	419900001-46, -60	■	MWT06 164 5456 125 09	■	6	54	56	56	9	–	12.5	0
	419900002-35	■	MWT12 164 5456 125 09	■	12	54	56	56	9	–	12.5	0
	419900003-34, -35	■	MWT12 164 5456 125 12	■	12	54	56	56	12	–	12.5	0
	419900004-34	■	MWT15 164 5456 125 09	■	15	54	56	56	9	–	12.5	0
	419900005-32	■	MWT15 164 5456 125 12	■	15	54	56	56	12	–	12.5	0
	419900006-32	■	MWT25 164 5456 125 09	■	25	54	56	56	9	–	12.5	0
	419900007-32	■	MWT25 164 5456 125 12	■	25	54	56	56	12	–	12.5	0
	419900010-30, -44	■	MWT12 164 5456 175 09	■	12	54	56	56	9	–	17.5	5
	419900011-30, -44	■	MWT12 164 5456 175 12	■	12	54	56	56	12	–	17.5	5
	419900012-30	■	MWT15 164 5456 175 09	■	15	54	56	56	9	–	17.5	5
	419900013-30	■	MWT25 164 5456 175 09	■	25	54	56	56	9	–	17.5	5
	419954000-45	■	MWT25 164 5456 175 12	■	25	54	56	56	12	–	17.5	5
	419954001-39, -46	■										
	419954002-35	■										
	419954003-34, -35	■										
	419954005-32	■										
	419954006-32	■										
	419954007-32	■										
	419954010-30, -44	■										
419954011-30, -44	■											
419954012-30	■											
419954013-30	■											
TN762006	■											
W & F	MPU.M0800.C16	■	MWT06 164 WF55 093 07	■	6	WF	55	55	7	–	9.3	0
	MPU.TO.0800.DE20S	■	MWT06 164 WF55 143 07	■	6	WF	55	55	7	–	14.3	5
	MPU.TO.M0800.CT20	■	MWT06 164 WF55 173 07	■	6	WF	55	55	7	–	17.3	8
	MPU.TO.M800.DE20	■	MWT06 164 WF55 093 09	■	6	WF	55	55	9	–	9.3	0
	MPU.Z30.M0800.XD20	■	MWT06 164 WF55 143 09	■	6	WF	55	55	9	–	14.3	5
	MPU.Z31.M0800.L20	■	MWT06 164 WF55 173 09	■	6	WF	55	55	9	–	17.3	8
	MPU.Z34.M0800.SR20	■	MWT12 164 WF55 093 09	■	12	WF	55	55	9	–	9.3	0
	MPU.Z35.M0800.GA	■	MWT12 164 WF55 143 09	■	12	WF	55	55	9	–	14.3	5
	MPU.LSW.101.M0800.L20N	■	MWT12 164 WF55 173 09	■	12	WF	55	55	9	–	17.3	8
	WFW.M0800.R-K HSK	■	MWT12 164 WF55 093 12	■	12	WF	55	55	12	–	9.3	0
		■	MWT12 164 WF55 143 12	■	12	WF	55	55	12	–	14.3	5
		■	MWT12 164 WF55 173 12	■	12	WF	55	55	12	–	17.3	8
		■	MWT15 164 WF55 093 09	■	15	WF	55	55	9	–	9.3	0
	■	MWT15 164 WF55 093 12	■	15	WF	55	55	12	–	9.3	0	

* z: Number of teeth

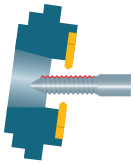

Type C

Attention
Only valid for inserts with 4 mm thickness (ΔL_T)



MWT...

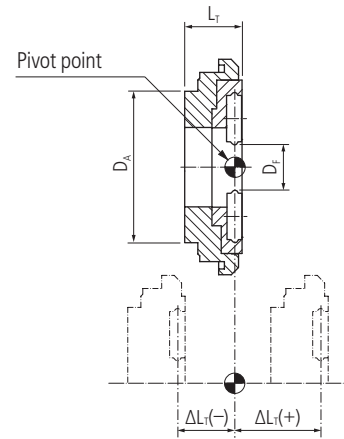

436

Driven toolholder		Whirling tool									
Manufacturer	Type	Order designation	Dimensions								ΔL_T ±
			D_F	D_A	D_K	D_M	z^*	L_A	L_T		

PREMIUM-LINE

UTILIS
multidec
swiss type tools

MADAULA	CZ.035.C16	■	MWT12 164 3546 169 03 QC	■	12	42	46	46	3	8.9	16.9	0
PCM	LSW-215-000	■	MWT12 164 4060 130 09 QC	■	12	40	60	60	9	11	13	0
	NN20-W15	■	MWT12 164 4060 130 12 QC	■	12	40	60	60	12	11	13	0
	LSW-424-000	■	MWT12 164 3546 169 03 QC	■	12	42	46	46	3	8.9	16.9	0
	GSW-210	■	MWT06 164 252838 120 07	■	6	25	38	28	7	6.5	12	0
		■	MWT06 164 252838 120 09	■	6	25	38	28	9	6.5	12	0
SR-10J-GSW-010	■	MWT06 164 2536 126 07	■	6	28	36	36	7	6.6	12.6	0	
	■	MWT06 164 2536 126 09	■	6	28	36	36	9	6.6	12.6	0	
TORNOS	306101	■	MWT06 164 4057 105 07 QC	■	6	40	57	57	7	2	10.5	0
			MWT06 164 4057 155 07 QC	■	6	40	57	57	7	7	15.5	5
			MWT06 164 4057 185 07 QC	■	6	40	57	57	7	10	18.5	8
			MWT06 164 4057 205 07 QC	■	6	40	57	57	7	12	20.5	10
			MWT06 164 4057 105 09 QC	■	6	40	57	57	9	2	10.5	0
			MWT06 164 4057 155 09 QC	■	6	40	57	57	9	7	15.5	5
			MWT06 164 4057 185 09 QC	■	6	40	57	57	9	10	18.5	8
			MWT06 164 4057 205 09 QC	■	6	40	57	57	9	12	20.5	10
			MWT08 164 4057 105 09 QC	■	8	40	57	57	9	2	10.5	0
			MWT08 164 4057 155 09 QC	■	8	40	57	57	9	7	15.5	5
			MWT08 164 4057 185 09 QC	■	8	40	57	57	9	10	18.5	8
			MWT08 164 4057 205 09 QC	■	8	40	57	57	9	12	20.5	10
			MWT12 164 4057 105 09 QC	■	12	40	57	57	9	2	10.5	0
			MWT12 164 4057 155 09 QC	■	12	40	57	57	9	7	15.5	5
			MWT12 164 4057 185 09 QC	■	12	40	57	57	9	10	18.5	8
			MWT12 164 4057 205 09 QC	■	12	40	57	57	9	12	20.5	10
			MWT12 164 4057 105 12 QC	■	12	40	57	57	12	2	10.5	0
			MWT12 164 4057 155 12 QC	■	12	40	57	57	12	7	15.5	5
			MWT12 164 4057 185 12 QC	■	12	40	57	57	12	10	18.5	8
			MWT12 164 4057 205 12 QC	■	12	40	57	57	12	12	20.5	10
			MWT15 164 4057 105 09 QC	■	15	40	57	57	9	2	10.5	0
			MWT15 164 4057 155 09 QC	■	15	40	57	57	9	7	15.5	5
			MWT15 164 4057 185 09 QC	■	15	40	57	57	9	10	18.5	8
			MWT15 164 4057 205 09 QC	■	15	40	57	57	9	12	20.5	10
			MWT15 164 4057 105 12 QC	■	15	40	57	57	12	2	10.5	0
			MWT15 164 4057 155 12 QC	■	15	40	57	57	12	7	15.5	5
			MWT15 164 4057 185 12 QC	■	15	40	57	57	12	10	18.5	8
MWT15 164 4057 205 12 QC	■	15	40	57	57	12	12	20.5	10			

* z: Number of teeth

Other versions on request

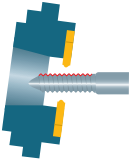

Attention
Only valid for inserts with 4 mm thickness (ΔL_T)

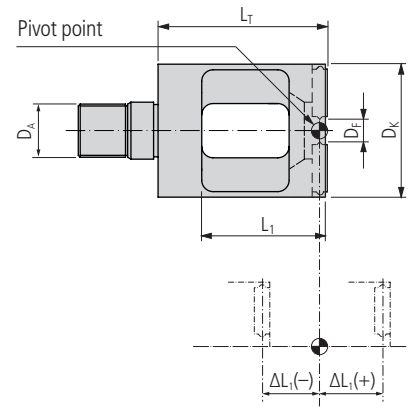

MWT... (TORNOS)

Driven toolholder		Whirling tool									
Manufacturer	Type	Order designation	Dimensions								
			D _F	D _A	D _K	z*	L _T	L ₁			ΔL_T
											±
TORNOS	305115	■ MWT06 164 M1435 440 07 ■	6	M14	35	7	44	32.5			0

* z: Number of teeth

Note
Maximum speed of tool (nt) 6000 rpm.
Tool must be balanced at faster speeds.

438

PREMIUM-LINE

UTILIS
multidec®
swiss type tools

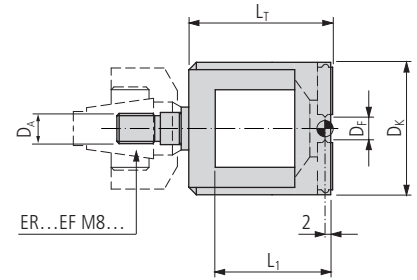
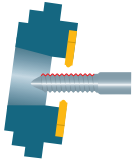

MWT... (ER)

Driven toolholder		Whirling tool										
Manufacturer	Type	Order designation	Dimensions									
			D _F	D _A	D _K	z*	L _T	L ₁				

PREMIUM-LINE

TORNOS	305115	■	MWT06 164 M1435 440 07	■	6	M14	35	7	44	32.5		
	418212	■	MWT12 164 M1441 440 09	■	12	M14	41	9	44	32.5		
	570952	■										
UTILIS	ER...EF...	■	MWT06 164 0400 07	■	6	M8	35	7	40	32.5		

* z: Number of teeth

Collets 654

Note
Maximum speed of tool (nt) 6000 rpm.
Tool must be balanced at faster speeds.

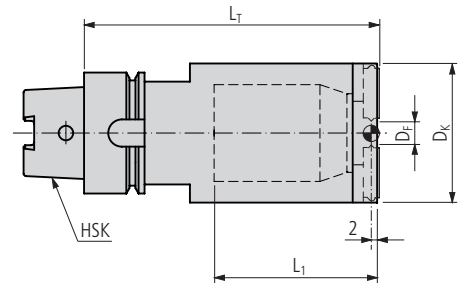
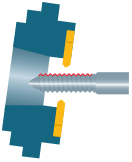

MWT... HSK...

440

Driven toolholder		Whirling tool										
Manufacturer	Type	Order designation	Dimensions									
			D _F	D _A	D _K	D _M	z*	L _T	L ₁			

PREMIUM-LINE

UTILIS
multidec
swiss type tools

UTILIS	A 40	■	MWT06 164 2646 0950 09 HSK40 A	■	6	HSK40 A	46	46	9	89	95	
			MWT08 164 2646 0950 09 HSK40 A	■	8	HSK40 A	46	46	9	89	95	
			MWT12 164 2646 0950 09 HSK40 A	■	12	HSK40 A	46	46	9	89	95	
			MWT12 164 2646 0950 12 HSK40 A	■	12	HSK40 A	46	46	12	89	95	
			MWT15 164 2646 0950 09 HSK40 A	■	15	HSK40 A	46	46	9	89	95	
	C 40	■	MWT25 164 3958 0710 09 HSK40 C	■	25	HSK40 C	58	58	9	61	71	
			MWT25 164 3958 0710 12 HSK40 C	■	25	HSK40 C	58	58	12	61	71	
	E 40	■	MWT06 164 2646 0920 09 HSK40 E	■	6	HSK40 E	46	46	9	86	92	
			MWT06 164 2646 0950 09 HSK40 E	■	6	HSK40 E	46	46	9	89	95	
			MWT08 164 2646 0920 09 HSK40 E	■	8	HSK40 E	46	46	9	86	92	
			MWT08 164 2646 0950 09 HSK40 E	■	8	HSK40 E	46	46	9	89	95	
			MWT12 164 2646 0920 09 HSK40 E	■	12	HSK40 E	46	46	9	86	92	
			MWT12 164 2646 0950 09 HSK40 E	■	12	HSK40 E	46	46	9	89	95	
			MWT12 164 2646 0920 12 HSK40 E	■	12	HSK40 E	46	46	12	86	92	
			MWT12 164 2646 0950 12 HSK40 E	■	12	HSK40 E	46	46	12	89	95	
			MWT15 164 2646 0920 09 HSK40 E	■	15	HSK40 E	46	46	9	86	92	
			MWT15 164 2646 0950 09 HSK40 E	■	15	HSK40 E	46	46	9	89	95	
			MWT15 164 2646 0920 12 HSK40 E	■	15	HSK40 E	46	46	12	86	92	
			MWT15 164 2646 0950 12 HSK40 E	■	15	HSK40 E	46	46	12	89	95	

* z: Number of teeth

Note
Maximum speed of tool (nt) 6000 rpm.
Tool must be balanced at faster speeds.

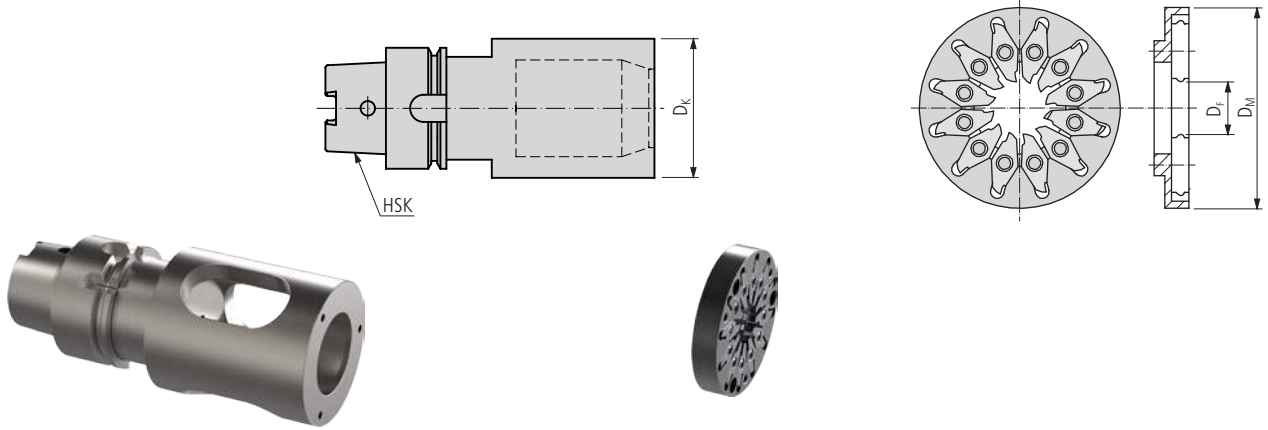

MWA HSK...

MWR...

Adapter				Whirling ring			
MWA HSK40A 890	MWA HSK40C 610	MWA HSK40E 860	MWA HSK40E 890	MWR06 164 2646 080 09	MWR08 164 2646 080 09	MWR12 164 2646 080 09	MWR12 164 2646 080 12
				MWR15 164 2646 080 09	MWR15 164 2646 080 12	MWR25 164 3958 100 09	MWR25 164 3958 100 12

Note
Maximum speed of tool (nt) 6000 rpm.
Tool must be balanced at faster speeds.

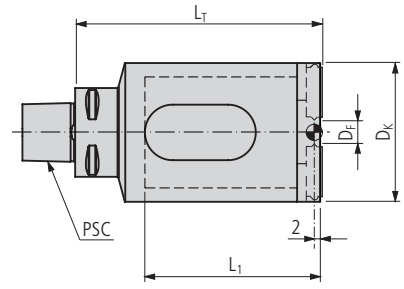
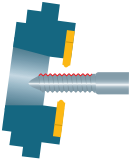

MWT... PSC...

Driven toolholder		Whirling tool										
Manufacturer	Type	Order designation	Dimensions									
			D _F	D _A	D _K	D _M	z*	L _T	L ₁			

442

PREMIUM-LINE

UTILIS	PSC	■	MWT06 164 PSC3250 0880 09	■	6	PSC32	50	46	9	80	88	
			MWT08 164 PSC3250 0880 09	■	8	PSC32	50	46	9	80	88	
			MWT12 164 PSC3250 0880 09	■	12	PSC32	50	46	9	80	88	
			MWT12 164 PSC3250 0880 12	■	12	PSC32	50	46	12	80	88	
			MWT15 164 PSC3250 0880 09	■	15	PSC32	50	46	9	80	88	
			MWT15 164 PSC3250 0880 12	■	15	PSC32	50	46	12	80	88	

* z: Number of teeth

Note

Maximum speed of tool (nt) 6000 rpm.
Tool must be balanced at faster speeds.

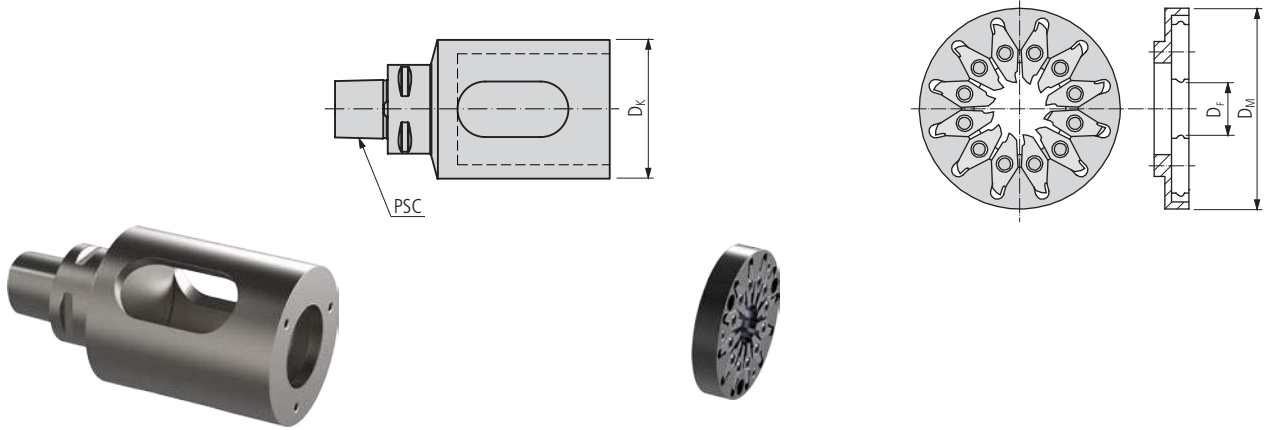

MWA PSC...

MWR...

Adapter										Whirling ring										
MWA PSC3250 800										MWR06 164 2646 080 09										
										MWR08 164 2646 080 09										
										MWR12 164 2646 080 09										
										MWR12 164 2646 080 12										
										MWR15 164 2646 080 09										
										MWR15 164 2646 080 12										

Note
 Maximum speed of tool (nt) 6000 rpm.
 Tool must be balanced at faster speeds.

Blank



1601-4.../6.../8...

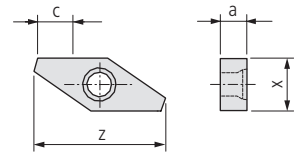

1601...

Order designation	Carbide				Dimensions				Holder
	UHM10	UHM 10 HX	UHM 20	UHM 20 HPX	a	c	x	z	
	■	■	○	●					
	■	●	○	●					
	○	●	○	●					
	●	○	●	○					
	■	■	■	■					
	■	■	■	■					
1601-4-5 N ...	■	■	■	■	4	5	6	16	MWR... / MWT...
1601-6-5 N ...	■	■	■	■	6	5	6	16	MWR... / MWT...
1601-8-5 N ...	■	■	■	■	8	5	6	16	MWR... / MWT...

444

UTILIS
multidec[®]
swiss type tools

STANDARD-LINE

Execution of special thread profil 462

Legend 8...

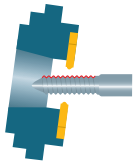

Threadwhirling full profile



MWI... HA... VP

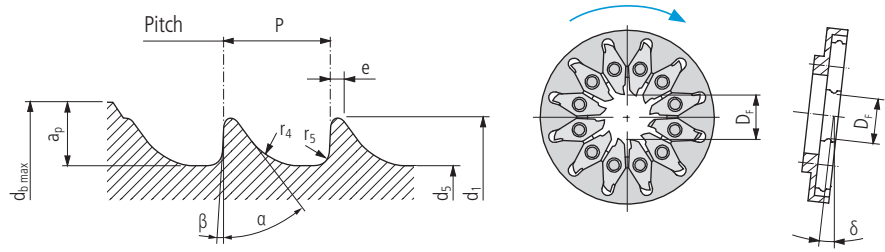

Order designation	Carbide						Standard	Dimensions												
	UHM 10	UHM 10 HX	UHM 10 TX+	UHM 20	UHM 20 HPX	UHM 20 TX+		ISO 5835	D _F *	d ₁	d ₅	Tolerance	P	δ	e	r ₄	r ₅	α/β	a _p	d _{b,max}
	-	-	●	○	●	●			0/-0.15											

STANDARD-LINE

MWI06 164 HA1.5 VP ...	■	■	■	■	■	■	HA1.5	6	1.5	1.1	0/-0.1	0.5	7.3°	0.1	0.3	0.1	35°/3°	3	7
MWI06 164 HA2.0 VP ...	■	■	■	■	■	■	HA2.0	6	2	1.3	0/-0.1	0.6	6.9°	0.1	0.4	0.1	35°/3°	3	7
MWI06 164 HA2.7 VP ...	■	■	■	■	■	■	HA2.7	6	2.7	1.9	0/-0.15	1	8.1°	0.1	0.6	0.2	35°/3°	3	7.5
MWI12 164 HA1.5 VP ...	■	■	■	■	■	■	HA1.5	12	1.5	1.1	0/-0.1	0.5	7.3°	0.1	0.3	0.1	35°/3°	4	9
MWI12 164 HA2.0 VP ...	■	■	■	■	■	■	HA2.0	12	2	1.3	0/-0.1	0.6	6.9°	0.1	0.4	0.1	35°/3°	4	9
MWI12 164 HA2.7 VP ...	■	■	■	■	■	■	HA2.7	12	2.7	1.9	0/-0.15	1	8.1°	0.1	0.6	0.2	35°/3°	4	9.5
MWI12 164 HA3.5 VP ...	■	■	■	■	■	■	HA3.5	12	3.5	2.4	0/-0.15	1.25	7.9°	0.1	0.8	0.2	35°/3°	4	10
MWI12 164 HA4.0 VP ...	■	■	■	■	■	■	HA4.0	12	4	2.9	0/-0.15	1.5	8.1°	0.1	0.8	0.2	35°/3°	4	10.5
MWI12 164 HA4.5 VP ...	■	■	■	■	■	■	HA4.5	12	4.5	3	0/-0.15	1.75	8.6°	0.1	1	0.3	35°/3°	4	11
MWI12 164 HA5.0 VP ...	■	■	■	■	■	■	HA5.0	12	5	3.5	0/-0.15	1.75	7.6°	0.1	1	0.3	35°/3°	4	11

MWI... HB... VP

Order designation	Carbide						Standard	Dimensions											
	UHM 10	UHM 10 HX	UHM 10 TX+	UHM 20	UHM 20 HPX	UHM 20 TX+		ISO 5835	D _F *	d ₁	d ₅	Tolerance	P	δ	e	r ₄	r ₅	α/β	a _p
	-	-	●	○	●	●			0/-0.15										

STANDARD-LINE

MWI12 164 HB4.0 VP ...	■	■	■	■	■	■	HB4.0	12	4	1.9	0/-0.15	1.75	11°	0.1	0.8	0.3	25°/5°	4	9.5
MWI12 164 HB6.5 VP ...	■	■	■	■	■	■	HB6.5	12	6.5	3	0/-0.15	2.75	10.6°	0.2	1.2	0.8	25°/5°	4	11

Execution of special thread profil 462

*** Note**
The flight circle (D_F) of the insert must match that of the whirling head.

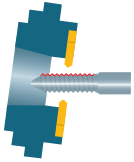

Threadwhirling full profile

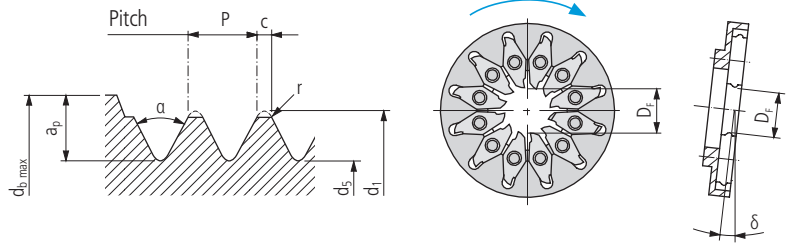

MWI... HC... VP

Order designation	Carbide						Standard	Dimensions									
	UHM 10	UHM 10 HX	UHM 10 TX+	UHM 20	UHM 20 HPX	UHM 20 TX+		D _F *	d ₁ min. max.	d ₅ min. max.	P	δ	c	r	α	a _p	d _{b,max}
	-	-	●	○	●	●	ISO 9268										
	○	●	●	○	●	●											
	●	○	-	●	○	-											
	-	-	●	-	-	○											

446



STANDARD-LINE

MWI06 164 HC2.9 VP ...	■	■	■	■	■	■	HC2.9	6	2.79	2.9	2.03	2.18	1.06	7.76°	0.1	0.05	60°	3	8.5
MWI06 164 HC3.5 VP ...	■	■	■	■	■	■	HC3.5	6	3.43	3.53	2.51	2.64	1.27	7.61°	0.1	0.05	60°	3	9
MWI06 164 HC3.9 VP ...	■	■	■	■	■	■	HC3.9	6	3.78	3.91	2.77	2.92	1.27	6.89°	0.1	0.05	60°	3	9.5
MWI06 164 HC4.2 VP ...	■	■	■	■	■	■	HC4.2	6	4.09	4.22	2.95	3.25	1.27	6.36°	0.1	0.05	60°	3	10
MWI12 164 HC2.9 VP ...	■	■	■	■	■	■	HC2.9	12	2.79	2.9	2.03	2.18	1.06	7.76°	0.1	0.05	60°	4	10.5
MWI12 164 HC3.5 VP ...	■	■	■	■	■	■	HC3.5	12	3.43	3.53	2.51	2.64	1.27	7.61°	0.1	0.05	60°	4	11
MWI12 164 HC3.9 VP ...	■	■	■	■	■	■	HC3.9	12	3.78	3.91	2.77	2.92	1.27	6.89°	0.1	0.05	60°	4	11.5
MWI12 164 HC4.2 VP ...	■	■	■	■	■	■	HC4.2	12	4.09	4.22	2.95	3.25	1.27	6.36°	0.1	0.05	60°	4	12

Execution of special thread profil 462

*** Note**
The flight circle (D_F) of the insert must match that of the whirling head.

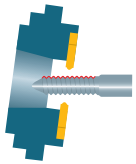

Threadwhirling full profile

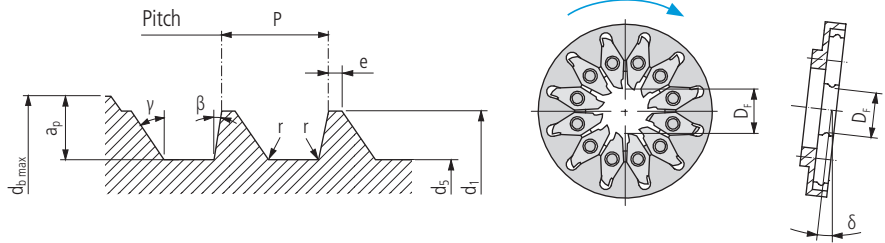

MWI... HD... VP

Order designation	Carbide						Standard	Dimensions											
	UHM 10	UHM 10 HX	UHM 10 TX+	UHM 20	UHM 20 HPX	UHM 20 TX+		ISO 9268	D _F *	d ₁ ±0.03	d ₅ ±0.03	P	δ	e	r	γ	β	a _p	d _{b max}
	-	-	●	○	●	●													
	-	●	●	○	●	●													
	○	○	-	●	○	-													
	-	-	●	-	-	○													

STANDARD-LINE

MWI06 164 HD4.0 VP ...	■	■	■	■	■	■	HD4.0	6	4	2.92	1.59	8.36°	0.1	0.01	45°	10°	3	9.5
MWI06 164 HD4.5 VP ...	■	■	■	■	■	■	HD4.5	6	4.5	2.92	2.18	10.64°	0.1	0.01	45°	10°	3	10
MWI12 164 HD4.0 VP ...	■	■	■	■	■	■	HD4.0	12	4	2.92	1.59	8.36°	0.1	0.01	45°	10°	4	11.5
MWI12 164 HD4.5 VP ...	■	■	■	■	■	■	HD4.5	12	4.5	2.92	2.18	10.64°	0.1	0.01	45°	10°	4	12

Execution of special thread profil 462

*** Note**
The flight circle (D_F) of the insert must match that of the whirling head.

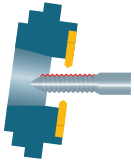

Threadwhirling full profile

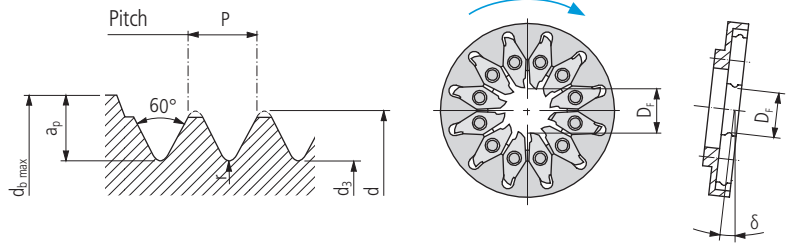

MWI... M... VP

Order designation	Carbide						Standard	Dimensions									
	UHM 10	UHM 10 HX	UHM 10 TX+	UHM 20	UHM 20 HPX	UHM 20 TX+		ISO DIN13	D _F *	d	d ₃	P	δ	r	a _p	d _{b,max}	
	-	-	●	○	●	●											
	○	●	●	○	●	●											
	●	○	-	●	○	-											
	-	-	●	-	○	○											

448

UTILIS multidec® swiss type tools

PREMIUM-LINE

MWI06 164 M1.4 VP ...	■	■	■	■	■	■	M1.4	6	1.4	1.012	0.3	4.53°			0.033	3	6.5
MWI06 164 M1.6 VP ...	■	■	■	■	■	■	M1.6	6	1.6	1.151	0.35	4.63°			0.041	3	7
MWI06 164 M2x0.25 VP ...	■	■	■	■	■	■	M2x0.25	6	2	1.693	0.25	2.5°			0.036	3	7.5
MWI06 164 M2 VP ...	■	■	■	■	■	■	M2	6	2	1.509	0.4	4.17°			0.048	3	7
MWI06 164 M3x0.35 VP ...	■	■	■	■	■	■	M3x0.35	6	3	2.571	0.35	2.3°			0.051	3	8.5
MWI06 164 M3 VP ...	■	■	■	■	■	■	M3	6	3	2.387	0.5	3.39°			0.062	3	8
MWI12 164 M1.6 VP ...	■	■	■	■	■	■	M1.6	12	1.6	1.151	0.35	4.63°			0.041	4	9
MWI12 164 M2x0.25 VP ...	■	■	■	■	■	■	M2x0.25	12	2	1.693	0.25	2.5°			0.036	4	9.5
MWI12 164 M2 VP ...	■	■	■	■	■	■	M2	12	2	1.509	0.4	4.17°			0.048	4	9
MWI12 164 M2.5 VP ...	■	■	■	■	■	■	M2.5	12	2.5	1.928	0.45	3.7°			0.055	4	9.5
MWI12 164 M3x0.35 VP ...	■	■	■	■	■	■	M3x0.35	12	3	2.571	0.35	2.3°			0.051	4	10.5

STANDARD-LINE

MWI12 164 M3 VP ...	■	■	■	■	■	■	M3	12	3	2.387	0.5	3.39°			0.062	4	10
MWI12 164 M3.5 VP ...	■	■	■	■	■	■	M3.5	12	3.5	2.744	0.6	3.5°			0.077	4	8.5
MWI12 164 M4x0.5 VP ...	■	■	■	■	■	■	M4x0.5	12	4	3.387	0.5	2.5°			0.072	4	11
MWI12 164 M4 VP ...	■	■	■	■	■	■	M4	12	4	3.141	0.7	3.58°			0.091	4	11
MWI12 164 M5x0.5 VP ...	■	■	■	■	■	■	M5x0.5	12	5	4.387	0.5	1.9°			0.072	4	12
MWI12 164 M5 VP ...	■	■	■	■	■	■	M5	12	5	4.019	0.8	3.24°			0.105	4	11.5
MWI12 164 M6x0.75 VP ...	■	■	■	■	■	■	M6x0.75	12	6	5.08	0.75	2.5°			0.108	4	13
MWI12 164 M6 VP ...	■	■	■	■	■	■	M6	12	6	4.773	1	3.39°			0.134	4	12.5
MWI12 164 M7 VP ...	■	■	■	■	■	■	M7	12	7	5.753	1	2.86°			0.134	4	13.5
MWI12 164 M8x0.75 VP ...	■	■	■	■	■	■	M8x0.75	12	8	7.08	0.75	1.8°			0.108	4	15
MWI12 164 M8 VP ...	■	■	■	■	■	■	M8	12	8	6.466	1.25	3.15°			0.17	4	14
MWI12 164 M8x1.0 VP ...	■	■	■	■	■	■	M8x1	12	8	6.773	1	2.5°			0.144	4	14.5
MWI12 164 M10x0.75 VP ...	■	■	■	■	■	■	M10x0.75	12	10	9.08	0.75	1.4°			0.108	4	17
MWI12 164 M10x1.0 VP ...	■	■	■	■	■	■	M10x1	12	10	8.773	1	1.9°			0.144	4	16.5
MWI12 164 M10x1.25 VP ...	■	■	■	■	■	■	M10x1.25	12	10	8.466	1.25	2.5°			0.18	4	16
MWI12 164 M10 VP ...	■	■	■	■	■	■	M10	12	10	8.16	1.5	3.01°			0.207	4	16

Execution of special thread profil 462

*** Note**
The flight circle (D_F) of the insert must match that of the whirling head.

Legend 8...

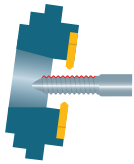

Threadwhirling full profile

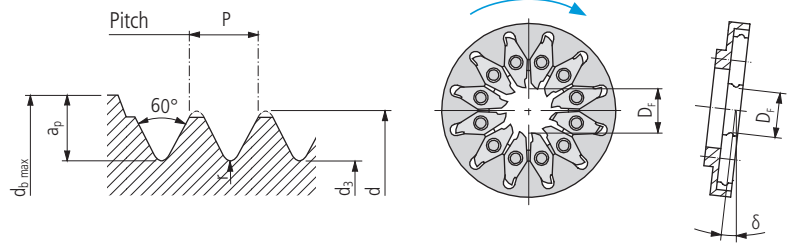

MWI...UNC VP

Order designation	Carbide						Standard**	Dimensions									
	UHM 10	UHM 10 HX	UHM 10 TX+	UHM 20	UHM 20 HPX	UHM 20 TX+		ANSI B1.1	D _F *	d	d ₃	P	δ	r	a _p	d _{b max}	
	-	-	●	●	○	●											
	○	●	●	●	○	●											
	●	○	-	●	○	-											
	-	-	●	-	○	-											

PREMIUM-LINE

MWI12 164 01-64UNC VP ...	■	■	■	■	■	■	01-64	12	1.854	1.347	0.397	4.51°		0.047	4	9.5
MWI12 164 02-56UNC VP ...	■	■	■	■	■	■	02-56	12	2.184	1.608	0.454	4.35°		0.055	4	10

STANDARD-LINE

MWI12 164 03-48UNC VP ...	■	■	■	■	■	■	03-48	12	2.515	1.845	0.529	4.42°		0.066	4	10
MWI12 164 04-40UNC VP ...	■	■	■	■	■	■	04-40	12	2.845	2.046	0.635	4.73°		0.082	4	10.5
MWI12 164 05-40UNC VP ...	■	■	■	■	■	■	05-40	12	3.175	2.376	0.635	4.17°		0.082	4	11
MWI12 164 06-32UNC VP ...	■	■	■	■	■	■	06-32	12	3.505	2.511	0.794	4.8°		0.105	4	11
MWI12 164 08-32UNC VP ...	■	■	■	■	■	■	08-32	12	4.166	3.172	0.794	3.94°		0.105	4	12
MWI12 164 10-24UNC VP ...	■	■	■	■	■	■	10-24	12	4.826	3.508	1.058	4.62°		0.143	4	12.5
MWI12 164 12-24UNC VP ...	■	■	■	■	■	■	12-24	12	5.486	4.168	1.058	3.99°		0.143	4	13
MWI12 164 1/4-20UNC VP ...	■	■	■	■	■	■	1/4-20	12	6.35	4.772	1.27	4.16°		0.173	4	14
MWI12 164 5/16-18UNC VP ...	■	■	■	■	■	■	5/16-18	12	7.95	6.199	1.411	3.63°		0.194	4	15.5
MWI12 164 3/8-16UNC VP ...	■	■	■	■	■	■	3/8-16	12	9.525	7.557	1.588	3.39°		0.219	4	17

** Tolerance class 2A and 3A on customer request

Execution of special thread profil 462

*** Note**
The flight circle (D_F) of the insert must match that of the whirling head.

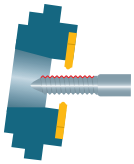

Threadwhirling full profile

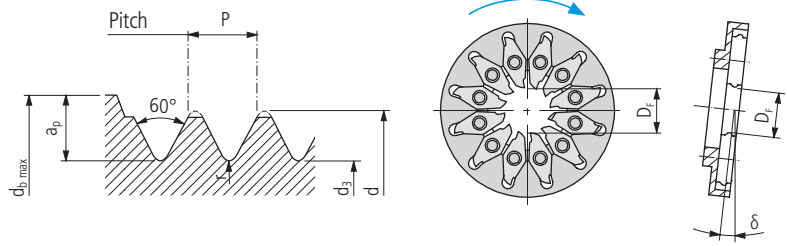

MWI...UNF VP

Order designation	Carbide						Standard**	Dimensions									
	UHM 10	UHM 10 HX	UHM 10 TX+	UHM 20	UHM 20 HPX	UHM 20 TX+		ANSI B.1.1	Df*	d	d3	P	δ	r	ap	db max	
	-	-	●	○	●	●											
	-	●	●	●	●	●											
	○	○	○	○	○	○											
	●	○	-	●	○	-											
	-	-	●	-	-	○											

450

UTILIS multidec® swiss type tools

PREMIUM-LINE

MWI12 164 00-80UNF VP ...	■	■	■	■	■	■	00-80	12	1.524	1.114	0.318	4.38°			0.036	4	9
MWI12 164 01-72UNF VP ...	■	■	■	■	■	■	01-72	12	1.854	1.401	0.353	3.95°			0.041	4	9.5
MWI12 164 02-64UNF VP ...	■	■	■	■	■	■	02-64	12	1.727	1.22	0.397	4.90°			0.047	4	9.5
MWI12 164 03-56UNF VP ...	■	■	■	■	■	■	03-56	12	2.515	1.938	0.454	3.71°			0.055	4	10

STANDARD-LINE

MWI12 164 04-48UNF VP ...	■	■	■	■	■	■	04-48	12	2.845	2.176	0.529	3.84°			0.066	4	10.5
MWI12 164 05-44UNF VP ...	■	■	■	■	■	■	05-44	12	3.175	2.447	0.577	3.74°			0.073	4	11
MWI12 164 06-40UNF VP ...	■	■	■	■	■	■	06-40	12	3.505	2.706	0.635	3.72°			0.082	4	11
MWI12 164 08-36UNF VP ...	■	■	■	■	■	■	08-36	12	4.166	3.28	0.706	3.45°			0.092	4	12
MWI12 164 10-32UNF VP ...	■	■	■	■	■	■	10-32	12	4.826	3.832	0.794	3.34°			0.105	4	10.5
MWI12 164 12-28UNF VP ...	■	■	■	■	■	■	12-28	12	5.486	4.354	0.907	3.36°			0.121	4	11
MWI12 164 1/4-28UNF VP ...	■	■	■	■	■	■	1/4-28	12	6.35	5.217	0.907	2.86°			0.121	4	14
MWI12 164 5/16-24UNF VP ...	■	■	■	■	■	■	5/16-24	12	7.95	6.632	1.058	2.65°			0.143	4	15.5
MWI12 164 3/8-24UNF VP ...	■	■	■	■	■	■	3/8-24	12	9.525	8.207	1.058	2.18°			0.143	4	17.5

** Tolerance class 2A and 3A on customer request

Execution of special thread profil 462

*** Note**
The flight circle (D_F) of the insert must match that of the whirling head.

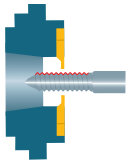

Cylindrical whirling

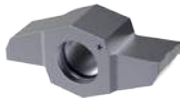

MWI... 1603...

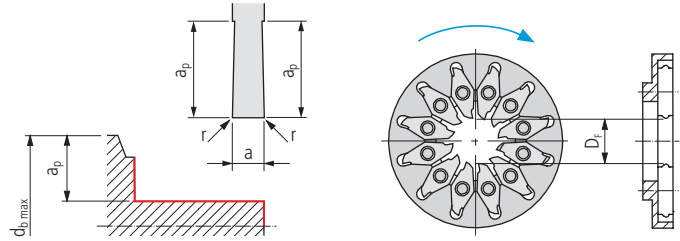

Order designation	Carbide						Dimensions									
	-	-	●	○	●	●	D _F *	a						r	a _p	d _b max
	-	-	●	○	●	●										
	○	●	●	○	○	●										
	●	○	-	●	○	-										
	-	-	●	-	○	○										
	UHM 10	UHM 10 HX	UHM 10 TX+	UHM 20	UHM 20 HPX	UHM 20 TX+										

STANDARD-LINE

MWI12 1603-0.4-3.5 ...	■	■	■	■	■	□	12	4						0.05	4	d+(2×a _p)
MWI12 1605-3.5-3.5 ...	■	■	■	■	■	□	12	3.5						0.05	4	d+(2×a _p)

*** Note**
The flight circle (D_F) of the insert must match that of the whirling head.

The multidec®-WHIRLING box contains tools for daily use on the machine. The protective foam inlay ensures that the parts are always located at the same place in the case. Spaces are provided for the whirling head for specific applications and the matching whirling plates (4 unmounted sets in all). Dummies can be supplied optionally to protect vacant plate positions.



Illustration with whirling head and plates (these have to be ordered separately)

Contents:

- Handle for torque screwdriver 1.2 Nm
- Alternative torque screwdriver blade for Torx screws
- Allen key
- High performance grease
- Spare screws for the whirling adapter and whirling ring
- Spare Torx screws for the indexing plates

STARTER-SET

Order designation

Starter-Set



The digital inclinometer gives you more flexibility in machine set-up and adjusting the thread pitch angle. The calculation and complicated movement by a certain distance are not required, particularly since the space situation in machines is not always the best. The UMI DI-490 (MEMS principle = Micro-Electro-Mechanical System) consists of a compact housing. Three magnets on the underside makes the attachment in the machine compartment easier. The zero point can be calibrated and stored internally, in order to change between relative and absolute measurement at any time.



UMI ...

Order designation

UMI DI-490

Technical data:

- Measuring accuracy 0.2°
- Measuring range (X) 4 × 90°
- Display resolution 0.05°
- Temperature range 0 to 40 °C
- Weight 200 g
- Protection class IP54

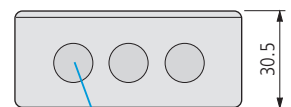
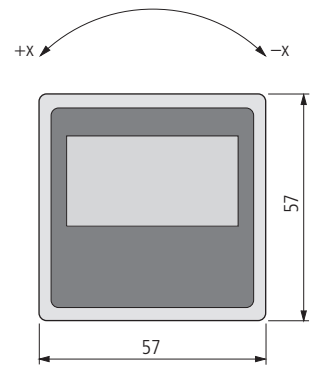

Magnet

Centering device for manual adjustment of the point height compensation with 3 different sizes of centering adapter for the guide bushing.

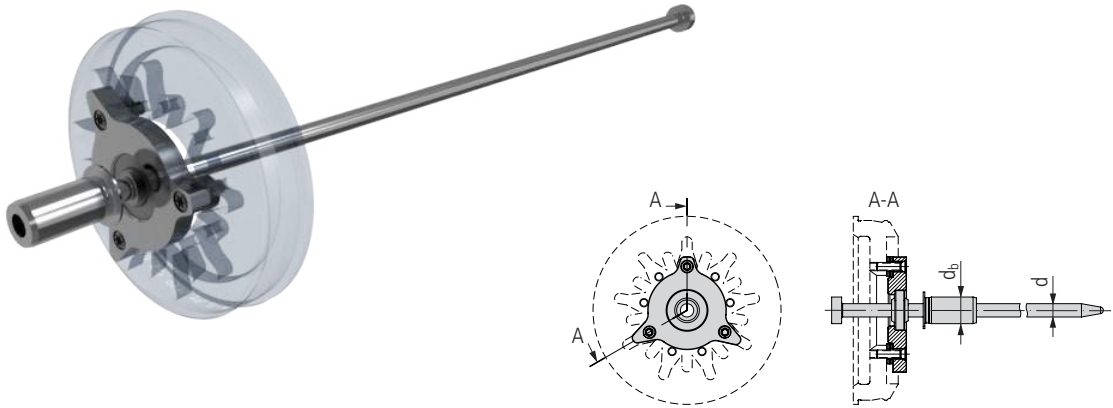

MWV...

Order designation		Dimensions			
		D_F	d	d_b	z
MWV06 07 402000	■	6	4	6, 8, 10	7
MWV06 00 402000	■	6	4	6, 8, 10	9, 12
MWV12 00 402000	■	12	4	6, 8, 10	9, 12
MWV15 00 402000	■	15	4	6, 8, 10	9, 12
MWV25 00 402000	■	25	4	6, 8, 10	9, 12



TORX screwdriver □ 651...

Explanation:









- D_F Cutting edge flying circle
- d Needle diameter
- d_b Bar diameter of guide bushing
- z Number of whirling tool teeth

Legend □ 8...

For inserts

Illustration	Description	Dimensions	Order designation	Inserts
	TORX screw	M2.5 × 6	MSP 25060 T08	■
		M2.5 × 7	MSP 25070 T08	■
		M2.5 × 9	MSP 25090 T08	■
	UTILIS MWI-Dummy		MWI DUMMY	■

For whirling tool/adapter

Illustration	Description	Dimensions	Order designation	Holder
	Flat-head socket screw	M3 × 8	MSP 30080 SE IB2.5	■
		M3 × 12	MSP 30120 SE IB2.5	■
		M4 × 6	MSP 40060 SE IB2.5	■
		M4 × 10	MSP 40100 SE IB2.5	■
		M4 × 12	MSP 40120 SE IB2.5	■
		M4 × 14	MSP 40140 SE IB2.5	■
	Socket head screw	M3 × 4	MSP 30040 IB2.5	■
		M3 × 6	MSP 30060 IB2.5	■
		M3 × 7	MSP 30070 IB2.5	■
		M3 × 8	MSP 30080 IB2.5	■
		M3 × 10	MSP 30100 IB2.5	■
		M3 × 12	MSP 30120 IB2.5	■
		M3 × 16	MSP 30160 IB2.5	■
		M3 × 20	MSP 30200 IB2.5	■
		M3 × 25	MSP 30250 IB2.5	■
		M4 × 8	MSP 40080 IB3	■
		M4 × 10	MSP 40100 IB3	■
		M4 × 12	MSP 40120 IB3	■
		M4 × 14	MSP 40140 IB3	■
		M4 × 16	MSP 40160 IB3	■
	Socket head screw DIN 7984	M3 × 8	MSP 30080 NK IB2.5	■
		M3 × 16	MSP 30160 NK IB2.5	■
		M4 × 6	MSP 40060 LK IB2.5	■
	Butt head screw	M4 × 10	MSP 40100 LK IB2.5	■
		M4 × 16	MSP 40160 LK IB2.5	■
		M3 × 7.3	MSP 30073 T08	■
	TORX screw	M3 × 9	MSP 30090 T08	■
		M3 × 11	MSP 30110 TP09 Torx Plus	■
		M3 × 16	MSP 30160 TP08 Torx Plus	■
		M3 × 7.3	MSP 30073 T10	■
		M4 × 9	MSP 40090 T15	■
		M4 × 11	MSP 40110 TP15 Torx Plus	■
		M4 × 14.4	MSP 40144 TP15 Torx Plus	■
	Set screw / grub screw	M3 × 5	MSP 30050 IB1.5	■
	Allen key	SW 1.5	MSP IB1.5	■
		SW 2	MSP IB2	■
		SW 2.5	MSP IB2.5	■
		SW 3	MSP IB3	■
		SW 4	MSP IB4	■
		SW 5	MSP IB5	■
		SW 6	MSP IB6	■
		SW 8	MSP IB8	■
		SW 10	MSP IB10	■
			TORX screwdriver	T08
T09	MSP TX-S09			■
T10	MSP TX-S10			■
T15	MSP TX-S15			■
TP08	MSP TXP-S08 Torx Plus			■
TP09	MSP TXP-S09 Torx Plus			■
TP10	MSP TXP-S10 Torx Plus			■
TP15	MSP TXP-S15 Torx Plus	■		

$$\tan \delta = \frac{P}{\pi \cdot d}$$

$$\delta = \frac{\arctan \cdot P}{\pi \cdot d}$$

$$v_f = z \cdot f_z \cdot n_t$$

$$n_t = \frac{v_c \cdot 1000}{\pi \cdot D_F}$$

$$n_b = \frac{v_f}{\pi \cdot d_3}$$

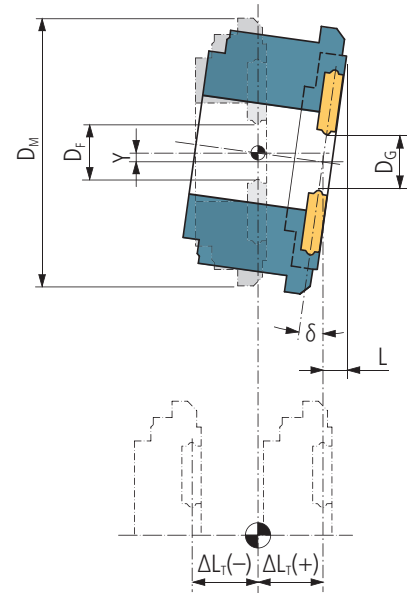
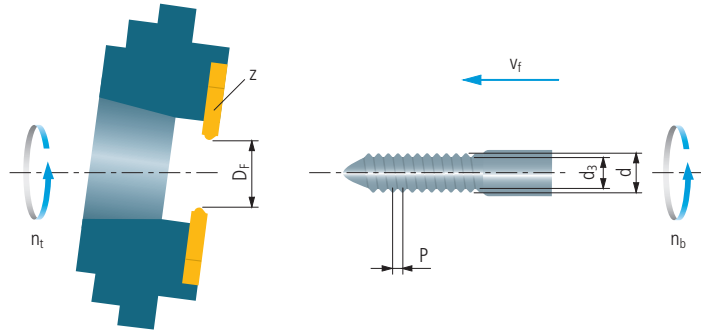
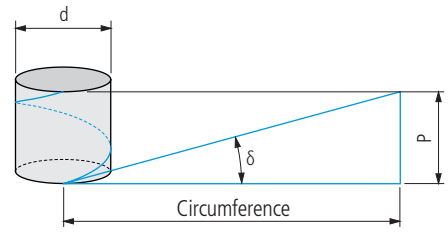

456

$$Y = \sin \delta \cdot \Delta L_T$$

Please visit our website www.utilis.com for further thread whirling calculations

Explanation

- d₃ Core diameter (mm)
- d₄ Thread diameter of work piece (mm)
- D_F Flight circle (mm)
- D_G Max. bar passage diameter (mm)
- D_M Ring diameter outside (mm)
- f_z Feed per tooth (mm)
- L Overhang length (mm)
- ΔL_T Positioning relative to the pivot point (mm)
- n_t Tool revolutions (rev/min)
- n_b Work piece revolutions (rev/min)
- P Pitch (mm)
- v_f Work piece feed (mm/min)
- v_c Cutting speed (m/min)
- Y Tip height adjustment
- z Number of teeth
- δ Lead angle (°)

The measurement of the length difference ΔL_T is appropriate for determination when the following situations exist:

- new whirling tool or holder
- checking the ΔL_T
- after a machine collision
- point height compensation

Outside the machine the length difference ΔL_T must be determined using the height measuring device for calculating the point height and correcting it if necessary using the following procedure:

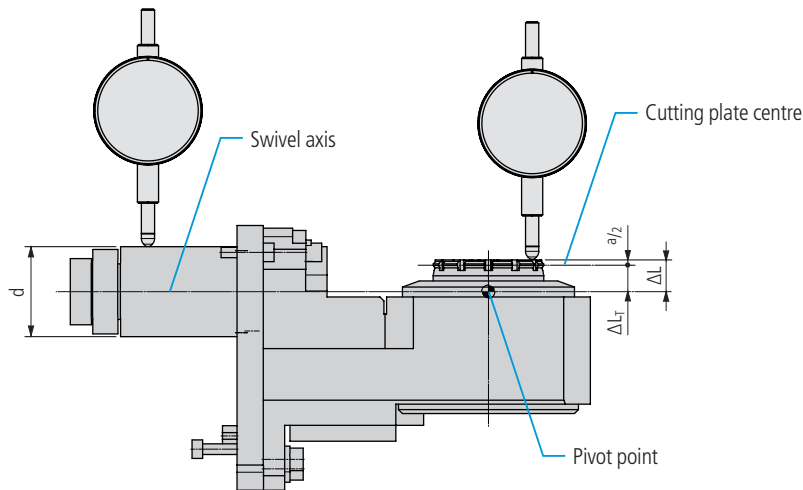

1. The swivel axis is usually the centre axis of the arbor. In order to do this, the diameter d must be measured and halved. This position must be zeroed and used as a reference for further measurement.
2. We take the uppermost surface of the cutting edge as the second measuring point. The difference results in ΔL
3. Use dimension $a/2$ (half the cutting edge width) in accordance with the whirling tool designation for the remaining calculation. The length difference ΔL_T is calculated from this, whereby the exact point height compensation can be adjusted.

See usage examples 456

Whirling tool designation	$a/2$	ΔL	$\Delta L_T = \Delta L - a/2$
MWT. 164	2		
MWT. 166	3		
MWT. 168	4		

Overhang length

Angle δ	Distance (Ring diameter outside)						
	L (D _M = 25)	L (D _M = 42)	L (D _M = 44)	L (D _M = 45)	L (D _M = 46)	L (D _M = 48)	L (D _M = 58)
0°	2	2	2	2	2	2	2
1°	2.4	2.7	2.8	2.8	2.8	2.8	3
2°	2.9	3.5	3.5	3.6	3.6	3.7	4
3°	3.3	4.2	4.3	4.4	4.4	4.5	5
4°	3.7	4.9	5.1	5.1	5.2	5.4	6.1
5°	4.2	5.7	5.8	5.9	6	6.2	7.1
6°	4.6	6.4	6.6	6.7	6.8	7	8.1
7°	5.1	7.2	7.4	7.5	7.6	7.9	9.1
8°	5.5	7.9	8.2	8.3	8.5	8.7	10.2
9°	6	8.7	9	9.1	9.3	9.6	11.2
10°	6.4	9.4	9.8	9.9	10.1	10.5	12.2
11°	6.9	10.2	10.6	10.7	10.9	11.3	13.3
12°	7.3	10.9	11.4	11.6	11.8	12.2	14.3
13°	7.8	11.7	12.2	12.4	12.6	13.1	15.4
14°	8.2	12.5	13	13.2	13.5	14	16.5
15°	8.7	13.3	13.8	14.1	14.3	14.9	17.5
16°	9.2	14	14.6	14.9	15.2	15.8	18.6
17°	9.6	14.8	15.5	15.8	16.1	16.7	19.7
18°	10.1	15.6	16.3	16.6	16.9	17.6	20.8
19°	10.6	16.5	17.2	17.5	17.8	18.5	22
20°	11.1	17.3	18	18.4	18.7	19.5	23.1
21°	11.6	18.1	18.9	19.3	19.7	20.4	24.3
22°	12.1	19	19.8	20.2	20.6	21.4	25.4
23°	12.6	19.8	20.7	21.1	21.5	22.4	26.6
24°	13.1	20.7	21.6	22	22.5	23.4	27.8
25°	13.7	21.6	22.5	23	23.5	24.4	29

458

Max. bar passage diameter

Angle δ	Distance			
	D _G	D _G	D _G	D _G
0° (D_F = D_G)	6	12	15	25
1°	6	12	15	25
2°	6	11.99	14.99	24.98
3°	5.99	11.98	14.98	24.97
4°	5.99	11.97	14.96	24.94
5°	5.98	11.95	14.94	24.9
6°	5.97	11.93	14.92	24.86
7°	5.96	11.91	14.89	24.81
8°	5.94	11.88	14.85	24.76
9°	5.93	11.85	14.82	24.69
10°	5.91	11.82	14.77	24.62
11°	5.89	11.78	14.72	24.54
12°	5.87	11.74	14.67	24.45
13°	5.85	11.69	14.62	24.36
14°	5.82	11.64	14.55	24.26
15°	5.8	11.59	14.49	24.15
16°	5.77	11.54	14.42	24.03
17°	5.74	11.48	14.34	23.91
18°	5.71	11.41	14.27	23.78
19°	5.67	11.35	14.18	23.64
20°	5.64	11.28	14.1	23.49
21°	5.6	11.2	14	23.34
22°	5.56	11.13	13.91	23.18
23°	5.52	11.05	13.81	23.01
24°	5.48	10.96	13.7	22.84
25°	5.44	10.88	13.59	22.66

	Steel unalloyed			Steel low alloyed			Steel high alloyed		
Hardness value (HB)/(HRC)	125–300 HB			180–250 HB			200–350 HB		
Category	I			II			III		
Machining method	▼	▼▼	▼▼▼	▼	▼▼	▼▼▼	▼	▼▼	▼▼▼
Feed per tooth	f_z (mm)								
	–	0.02–0.15	0.005–0.08	–	0.02–0.15	0.005–0.08	–	0.02–0.15	0.005–0.08
Depths of cut	a_p (mm)								
MWI06	3								
MWI12/15/25	4								
Cutting speeds	v_c (m/min)								
Cutting material carbide									
UHM 10	–	50–80	50–100	–	40–80	40–90	–	30–70	30–80
UHM 10 HPX	–	80–180	120–220	–	50–140	100–180	–	50–120	80–160
UHM 10 TX+	–	–	–	–	–	–	–	60–130	80–180
UHM 20	–	40–70	40–90	–	30–70	30–80	–	20–60	20–70
UHM 20 HX	–	70–160	110–200	–	40–130	90–170	–	40–110	70–150
UHM 20 TX+	–	–	–	–	–	–	–	–	–

	Stainless steel			Stainless steel			Titanium		
Hardness value (HB)/(HRC)	180–220 HB			220–330 HB			–		
Category	V			VI			IV		
Machining method	▼	▼▼	▼▼▼	▼	▼▼	▼▼▼	▼	▼▼	▼▼▼
Feed per tooth	f_z (mm)								
	–	0.01–0.1	0.005–0.05	–	0.01–0.1	0.005–0.05	–	0.01–0.08	0.005–0.05
Depths of cut	a_p (mm)								
MWI06	3								
MWI12/15/25	4								
Cutting speeds	v_c (m/min)								
Cutting material carbide									
UHM 10	–	50–100	50–120	–	30–70	40–80	–	30–70	40–80
UHM 10 HPX	–	80–150	100–160	–	50–100	70–120	–	50–100	70–120
UHM 10 TX+	–	80–160	100–170	–	50–120	70–140	–	50–120	70–140
UHM 20	–	40–90	40–100	–	20–60	30–70	–	20–60	30–70
UHM 20 HX	–	70–140	90–150	–	40–90	60–110	–	40–90	60–110
UHM 20 TX+	–	–	–	–	–	–	–	–	–

	Aluminum			Brass			Hard materials		
Hardness value (HB)/(HRC)	60–130 HB			–			45–70 HRC		
Category	VII			VIII			X		
Machining method	▼	▼▼	▼▼▼	▼	▼▼	▼▼▼	▼	▼▼	▼▼▼
Feed per tooth	f_z (mm)								
	–	–	–	–	0.02–0.15	0.005–0.1	–	0.01–0.08	0.005–0.05
Depths of cut	a_p (mm)								
MWI06	3								
MWI12/15/25	4								
Cutting speeds	v_c (m/min)								
Cutting material carbide									
UHM 10	–	–	–	–	50–140	50–160	–	–	–
UHM 10 HPX	–	–	–	–	–	–	–	–	–
UHM 10 TX+	–	–	–	–	–	–	–	15–40	20–80
UHM 20	–	–	–	–	40–130	40–150	–	–	–
UHM 20 HX	–	–	–	–	–	–	–	–	–
UHM 20 TX+	–	–	–	–	–	–	–	–	–

Cutting position

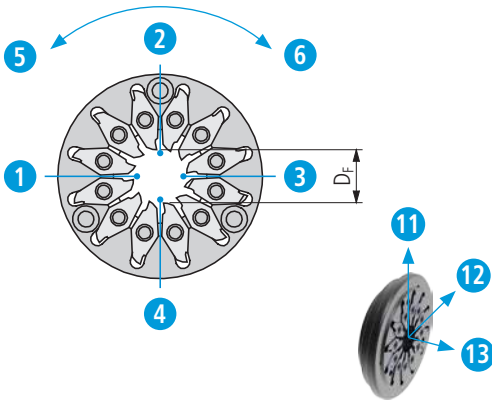

Turning direction of whirling unit

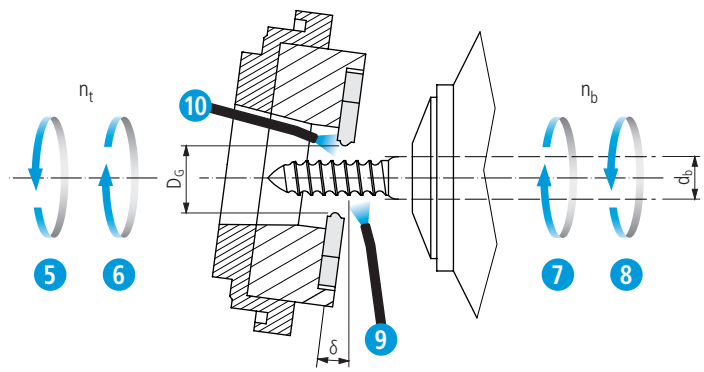

Turning direction of the bar

462

UTILIS
multidec®
SWISS type tools

Machine specifications					
Manufacturer					
Type					
Manufacturer of driven tool					
Type of driven tool					
Flight circle D _F	(mm)	<input type="checkbox"/>	<input type="checkbox"/>	<input type="checkbox"/>	<input type="checkbox"/>
		6	12	15	25
Mounting place (turret, gang rack, elsewhere)					
Enter axes (X, Y, Z)	<input type="checkbox"/>	<input type="checkbox"/>	<input type="checkbox"/>		
		11	12	13	
High pressure cooling?	(bar)	<input type="checkbox"/>	<input type="checkbox"/>	<input type="checkbox"/>	
		≤30	>30	No	
Cooling direction		<input type="checkbox"/>	<input type="checkbox"/>		
		9	10		
Turning direction of whirling unit	(n _t)	<input type="checkbox"/>	<input type="checkbox"/>		
	n _t = n _b	5	6		

Material					
Designation	(DIN)				
Bar diameter	(d _b)				
Turning direction of the bar	(n _b)	<input type="checkbox"/>	<input type="checkbox"/>		
	n _b = n _t	7	8		
Cutting position		<input type="checkbox"/>	<input type="checkbox"/>	<input type="checkbox"/>	<input type="checkbox"/>
		1	2	3	4

Insert			
Thread drawing	(No.)		
Full profile	<input type="checkbox"/>	<input type="checkbox"/>	
	Yes	No	
Number of thread starts	<input type="checkbox"/>	<input type="checkbox"/>	<input type="checkbox"/>
	1	2	3
Coating	<input type="checkbox"/>	<input type="checkbox"/>	
	Yes	No	

Company _____

Responsible person _____

Road _____

Postal code, City _____

Phone _____

Fax _____

E-mail _____

UTILIS®
Tooling for High Technology

■ Utilis AG, Precision Tools
Kreuzlingerstrasse 22, CH-8555 Müllheim, Switzerland
Phone +41 52 762 62 62, Fax +41 52 762 62 00
info@utilis.com, www.utilis.com

Cutting position

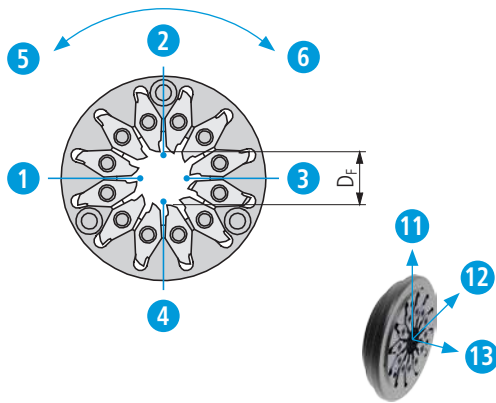

Turning direction of whirling unit

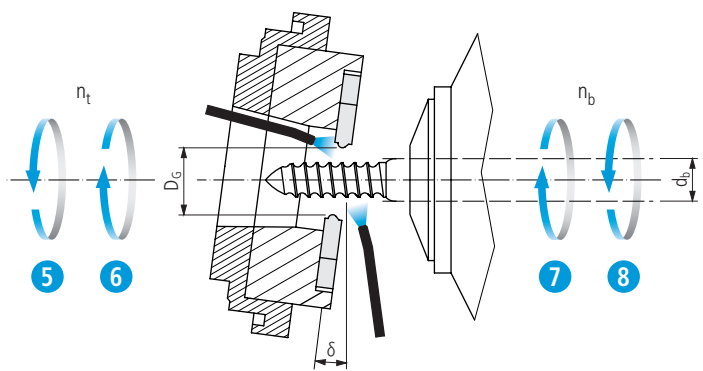

Turning direction of the bar

Machine specifications			
Turning direction of whirling unit	(n_t)	<input type="checkbox"/>	<input type="checkbox"/>
	$n_t = n_b$	<input checked="" type="checkbox"/> 5	<input checked="" type="checkbox"/> 6
High-pressure cooling in place?	(bar)	<input type="checkbox"/>	<input type="checkbox"/>
	≤ 30	<input type="checkbox"/>	<input type="checkbox"/>
	> 30	<input type="checkbox"/>	<input type="checkbox"/> No
Is the guide bush set flush?		<input type="checkbox"/>	<input type="checkbox"/>
	Yes	<input type="checkbox"/>	<input type="checkbox"/> No
Distance to the guide bush	$(< d_b)$	<input type="checkbox"/>	<input type="checkbox"/>

Driven tool			
Manufacturer			
Type			
Has the gradient angle been set?	$(^\circ)$	<input type="checkbox"/>	<input type="checkbox"/>
	Yes	<input type="checkbox"/>	<input type="checkbox"/> No
Enter axes (X, Y, Z)		<input type="checkbox"/>	<input type="checkbox"/>
		<input checked="" type="checkbox"/> 11	<input checked="" type="checkbox"/> 12
		<input checked="" type="checkbox"/> 13	<input type="checkbox"/>
Center height corrected?		<input type="checkbox"/>	<input type="checkbox"/>
	Yes	<input type="checkbox"/>	<input type="checkbox"/> No
Type of whirling head			
Concentricity set to max. $5 \mu m$?		<input type="checkbox"/>	<input type="checkbox"/>
	Yes	<input type="checkbox"/>	<input type="checkbox"/> No
Condition of whirling head	$(MWT...)$		

Material			
Bar diameter	(d_b)	<input type="checkbox"/>	<input type="checkbox"/>
Turning direction of the bar	(n_b)	<input type="checkbox"/>	<input type="checkbox"/>
	$n_b = n_t$	<input checked="" type="checkbox"/> 7	<input checked="" type="checkbox"/> 8
Cutting position		<input type="checkbox"/>	<input type="checkbox"/>
		<input checked="" type="checkbox"/> 1	<input checked="" type="checkbox"/> 2
		<input checked="" type="checkbox"/> 3	<input checked="" type="checkbox"/> 4
		<input type="checkbox"/>	<input type="checkbox"/>
Cutting speed / feed	(v_f / f_z)		
Problem with chips?		<input type="checkbox"/>	<input type="checkbox"/>
	Yes	<input type="checkbox"/>	<input type="checkbox"/> No
Vibrations?		<input type="checkbox"/>	<input type="checkbox"/>
	Yes	<input type="checkbox"/>	<input type="checkbox"/> No

Insert			
Order designation			
Cutting edge screwed tight with 1.2 Nm?		<input type="checkbox"/>	<input type="checkbox"/>
	Yes	<input type="checkbox"/>	<input type="checkbox"/> No
Centre of profile at point of rotation?		<input type="checkbox"/>	<input type="checkbox"/>
	Yes	<input type="checkbox"/>	<input type="checkbox"/> No
Distance to point of rotation	(mm)		
Cutting from the same production batch?		<input type="checkbox"/>	<input type="checkbox"/>
	Yes	<input type="checkbox"/>	<input type="checkbox"/> No
Are cutting edges evenly worn?		<input type="checkbox"/>	<input type="checkbox"/>
	Yes	<input type="checkbox"/>	<input type="checkbox"/> No
Cutting edges cleaned prior to fitting/change?		<input type="checkbox"/>	<input type="checkbox"/>
	Yes	<input type="checkbox"/>	<input type="checkbox"/> No

Tool Systems enables UTILIS inserts to be used on various well-known lathe tool systems. High quality UTILIS inserts like multidec®-CUT, -TOP and -BORE MICRO can therefore also be fitted on other manufacturers' cutting tool interfaces. This gives users maximum flexibility and independence. On the following pages, UTILIS proposes a wide range of holders for tool systems and machine-based tool systems.

Tool systems for turning machines and Swiss-type automatic lathes



multidec®-SHORT



multidec®-BACKTOOLS

multidec®-MODULENE



multidec®-HSK



multidec®-PSC



multidec®-KM™

Tool system for turn-mill machines

multidec®-MULTITASK



Machine-based tool systems













multidec®-ESCOMATIC



multidec®-TORNOS DECO

Overview – Tool Systems

Technical information		11
Tool systems for turning machines and Swiss type automatic lathes		
Overview multidec®-SHORT		467
Overview multidec®-BACKTOOLS		475
Overview multidec®-MODULENE		517
Overview multidec®-KM™		529
Overview multidec®-HSK		537
Overview multidec®-PSC		549
Tool system for turn-mill machines		
Overview multidec®-MULTITASK		559
Machine-based tool systems		
Overview multidec®-ESCOMATIC		583
Overview multidec®-TORNOS DECO		591
Special tools – multidec4you®		600
Accessories		651

multidec®-SHORT is a range of holders with short holders multidec®-CUT, -ISO and -TOP indexable inserts. All holders are equipped with internal cooling.



Benefits:

- All holders feature three connecting options for the coolant supply
- Fixed coolant discharge, therefore low build-up at front at the holder
- With or without high pressure, the coolant medium always hits the cutting edge precisely

Compatibility with QS quick tool change system:

multidec®-SHORT holders can also be used in the QS quick tool change system from Sandvik Coromant. The coolant transfer tube can be screwed into the holder at the rear fur using the internal coolant supply.



Overview – multidec®-SHORT

Technical information

11

Holders



468

Replacement and spare parts



473



"SHORT" version with internal cooling

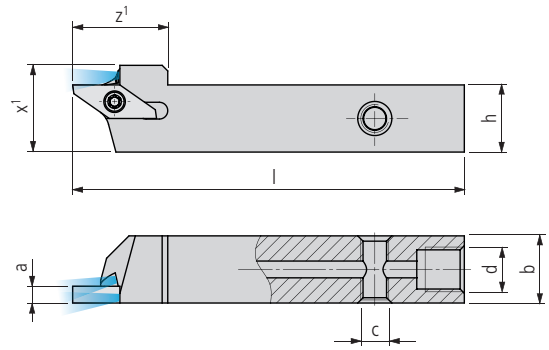

1600... IC-S

Order designation		Dimensions								Inserts		
L	R	h	b	l	a	z¹	x¹	c	d	□49...		
PREMIUM-LINE												
1600-12x70 L IC-S	■	1600-12x70 R IC-S	■	12	12	70	3	17	15.5	M5	M8×1	16...
1600-16x70 L IC-S	■	1600-16x70 R IC-S	■	16	16	70	3	17	19.5	M5	M8×1	16...

1600... IC-S INCH

Order designation		Dimensions								Inserts		
L	R	h	b	l	a	z¹	x¹	c	d	□49...		
PREMIUM-LINE												
1600-1/2"x70 L IC-S	■	1600-1/2"x70 R IC-S	■	12.7	12.7	70	3	17	16.2	M5	M8×1	16...
1600-5/8"x70 L IC-S	■	1600-5/8"x70 R IC-S	■	15.875	15.875	70	3	17	19.375	M5	M8×1	16...

Scope of delivery: Holder without coolant connector

Coolant system □619...



"SHORT" version with internal cooling

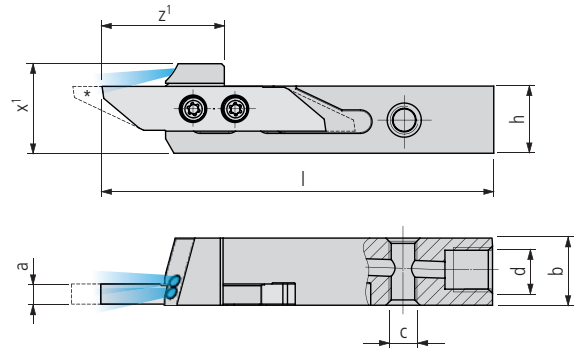

3000... IC-S

Order designation		Dimensions									Inserts	
L	R	h	b	l	a	z ¹	x ¹	c	d	□ 111...		
PREMIUM-LINE												
3000-12x70 L IC-S	■	3000-12x70 R IC-S	■	12	12	70	3	22	16	M5	M8×1	30...
3000-16x70 L IC-S	■	3000-16x70 R IC-S	■	16	16	70	3	22	20	M5	M8×1	30...

3000... IC-S INCH

Order designation		Dimensions									Inserts	
L	R	h	b	l	a	z ¹	x ¹	c	d	□ 111...		
PREMIUM-LINE												
3000-1/2"x70 L IC-S	■	3000-1/2"x70 R IC-S	■	12.7	12.7	70	3	22	16.7	M5	M8×1	30...
3000-5/8"x70 L IC-S	■	3000-5/8"x70 R IC-S	■	15.875	15.875	70	3	22	19.875	M5	M8×1	30...

- Long insert z¹ + 5 mm

Scope of delivery: Holder without coolant connector
 Coolant system □ 619...

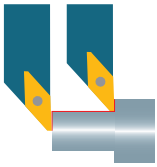

"SHORT" version with internal cooling

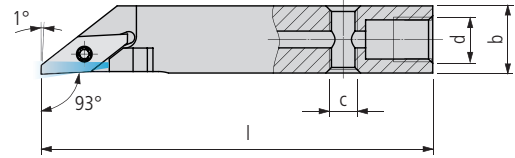
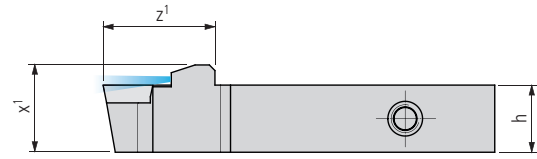

SVJP... IC-S (93°)

Order designation		Dimensions								Inserts
L	R	h	b	l	z¹	x¹	c	d	□ 305...	

PREMIUM-LINE

SVJPL 12 E10 IC-S	■	SVJPR 12 E10 IC-S	■	12	12	70	20	15.6	M5	M8 × 1	VP..1003..
SVJPL 16 E10 IC-S	■	SVJPR 16 E10 IC-S	■	16	16	70	20	19.6	M5	M8 × 1	VP..1003..

470

SVJP... IC-S (93°) INCH

Order designation		Dimensions								Inserts
L	R	h	b	l	z¹	x¹	c	d	□ 305...	

PREMIUM-LINE

SVJPL 1/2" E10 IC-S	■	SVJPR 1/2" E10 IC-S	■	12.7	12.7	70	20	16.3	M5	M8 × 1	VP..1003..
SVJPL 5/8" E10 IC-S	■	SVJPR 5/8" E10 IC-S	■	15.875	15.875	70	20	19.475	M5	M8 × 1	VP..1003..

Scope of delivery: Holder without coolant connector

Coolant system □ 619...

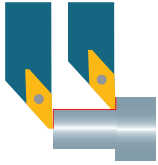

Reinforced version V "SHORT" with internal cooling

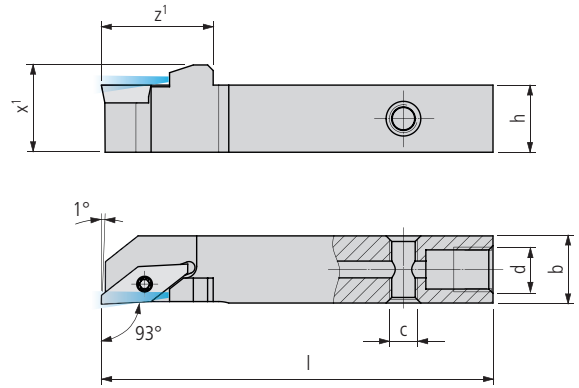

SVJP... V IC-S (93°)

Order designation		Dimensions								Inserts	
L	R	h	b	l	z¹	x¹	c	d	□ 305...		
PREMIUM-LINE											
SVJPL 12 E10 V IC-S	■	SVJPR 12 E10 V IC-S	■	12	12	70	20	15.6	M5	M8 × 1	VP..1003..
SVJPL 16 E10 V IC-S	■	SVJPR 16 E10 V IC-S	■	16	16	70	20	19.6	M5	M8 × 1	VP..1003..

SVJP... V IC-S (93°) INCH

Order designation		Dimensions								Inserts	
L	R	h	b	l	z¹	x¹	c	d	□ 305...		
PREMIUM-LINE											
SVJPL 1/2" E10 V IC-S	■	SVJPR 1/2" E10 V IC-S	■	12.7	12.7	70	20	16.3	M5	M8 × 1	VP..1003..
SVJPL 5/8" E10 V IC-S	■	SVJPR 5/8" E10 V IC-S	■	15.875	15.875	70	20	19.475	M5	M8 × 1	VP..1003..

Scope of delivery: Holder without coolant connector

Coolant system □ 619...

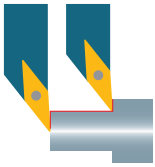

"SHORT" version with internal cooling

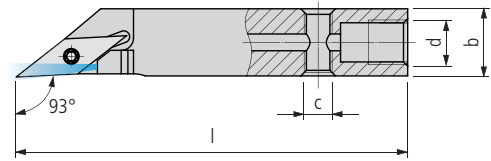
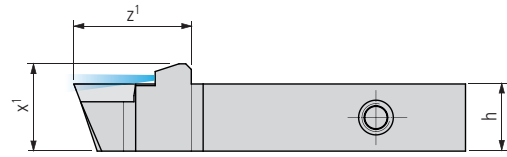

SVJC... IC-S (93°)

Order designation		Dimensions								Inserts
L	R	h	b	l	z¹	x¹	c	d	□ 259...	

PREMIUM-LINE

SVJCL 12 E07 IC-S	■	SVJCR 12 E07 IC-S	■	12	12	70	20	15.6	M5	M8×1	VC..0702..
SVJCL 12 E11 IC-S	■	SVJCR 12 E11 IC-S	■	12	12	70	21	15.6	M5	M8×1	VC..1103..
SVJCL 16 E11 IC-S	■	SVJCR 16 E11 IC-S	■	16	16	70	21	19.6	M5	M8×1	VC..1103..

472

SVJC... IC-S (93°) INCH

Order designation		Dimensions								Inserts
L	R	h	b	l	z¹	x¹	c	d	□ 259...	

PREMIUM-LINE

SVJCL 1/2" E07 IC-S	■	SVJCR 1/2" E07 IC-S	■	12.7	12.7	70	20	16.3	M5	M8×1	VC..0702..
SVJCL 1/2" E11 IC-S	■	SVJCR 1/2" E11 IC-S	■	12.7	12.7	70	21	16.3	M5	M8×1	VC..1103..
SVJCL 5/8" E11 IC-S	■	SVJCR 5/8" E11 IC-S	■	15.875	15.875	70	21	19.475	M5	M8×1	VC..1103..

Scope of delivery: Holder without coolant connector
Coolant system □ 619...

Illustration	Description	Dimensions	Order designation	Holder
	TORX screw	M2.5 × 6 T08	MSP 25060 T08	1600... SV.P.10 SV... 11
		M3 × 9 T08	MSP 30090 T08	3000...
		M2 × 5.5	MSP 20055 T06	VC... 07

TORX screwdriver 651...

multidec®-BACKTOOLS is a product range used for reverse-side machining on Swiss type turning machines with counter spindles. The tool enables a part to be fully machined in a single operation.









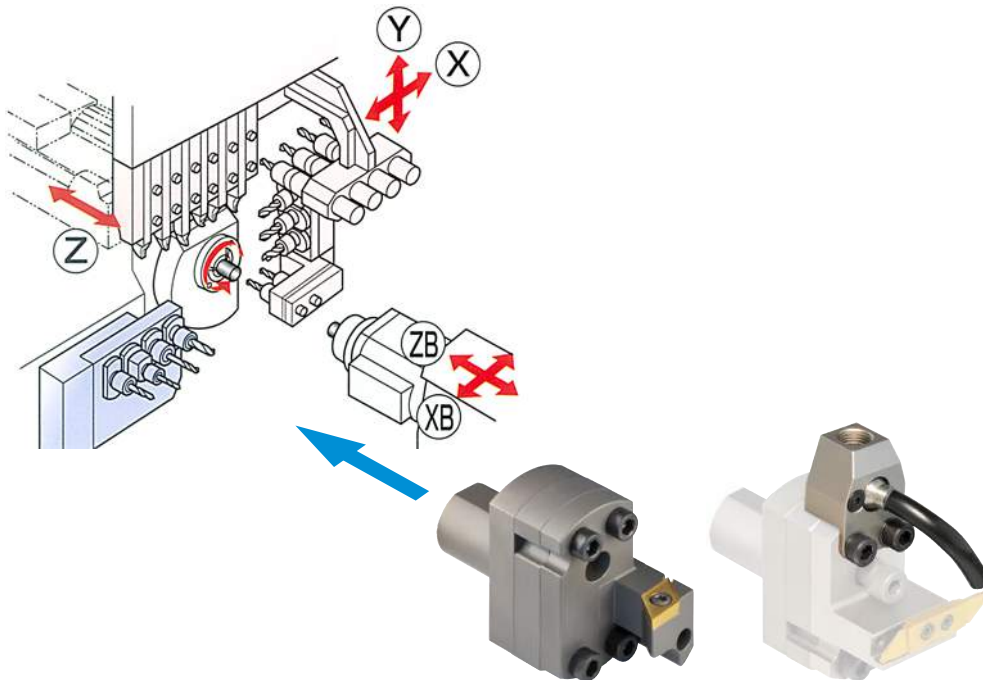





This modular system is characterized by outstanding stability and versatility.



Advantages:

- Complete machining in a single operation is possible
- High stability
- Modular design
 - Basic tool holder
 - Spacer
 - Insert holder
- Precise and convenient center height adjustment by means of an excentric screw for machines without Y-axis (± 0.5 mm)
- Internal cooling possible
- Basic tool holder for common machines



Technical information		11
Mounting		476
Basic tool holders / Double basic tool holder		477
Basic tool holders for PCM broaching toolholder		491
Special combination holder and collet holder		492
Direct combination holder		494
Holders for inserts		495
Holders for OD turning tools		506
Collet holders / Extension attachment		507
Holders for ID turning tools of multidec®-BORE MICRO		509
Holders for ID turning tools		510
Reduction sleeve		511
Spacer and adjusting sheet		512
Cooling adapter		514
Replacement and spare parts		589

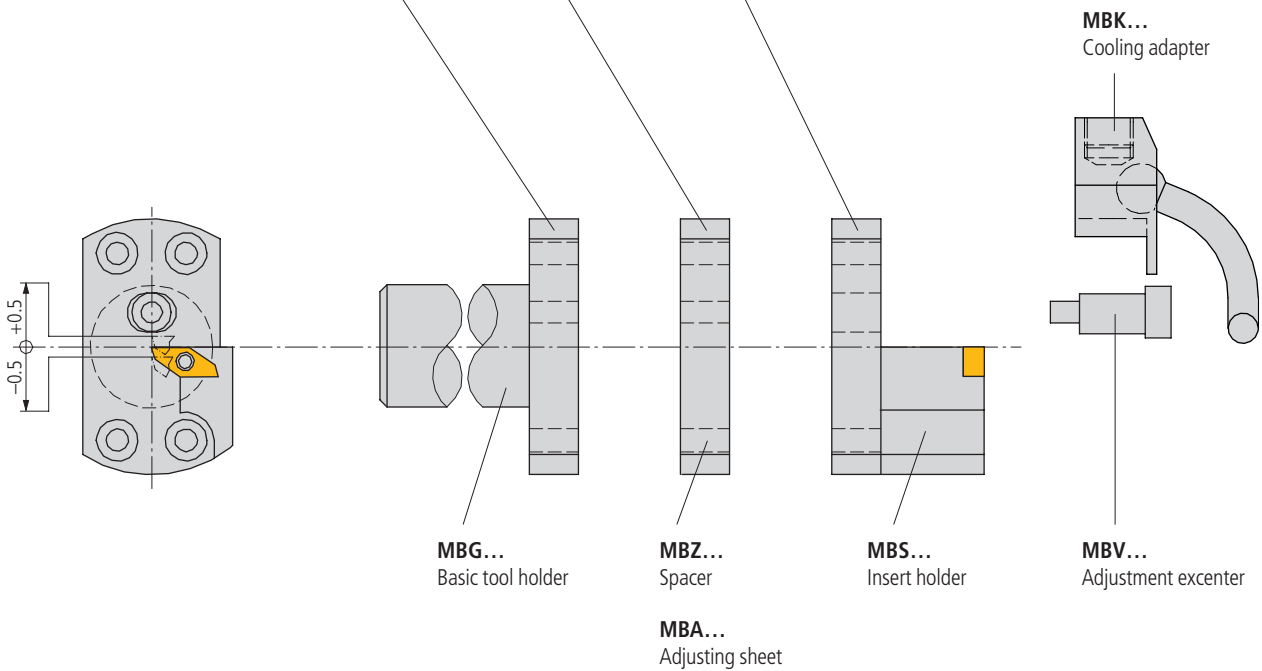
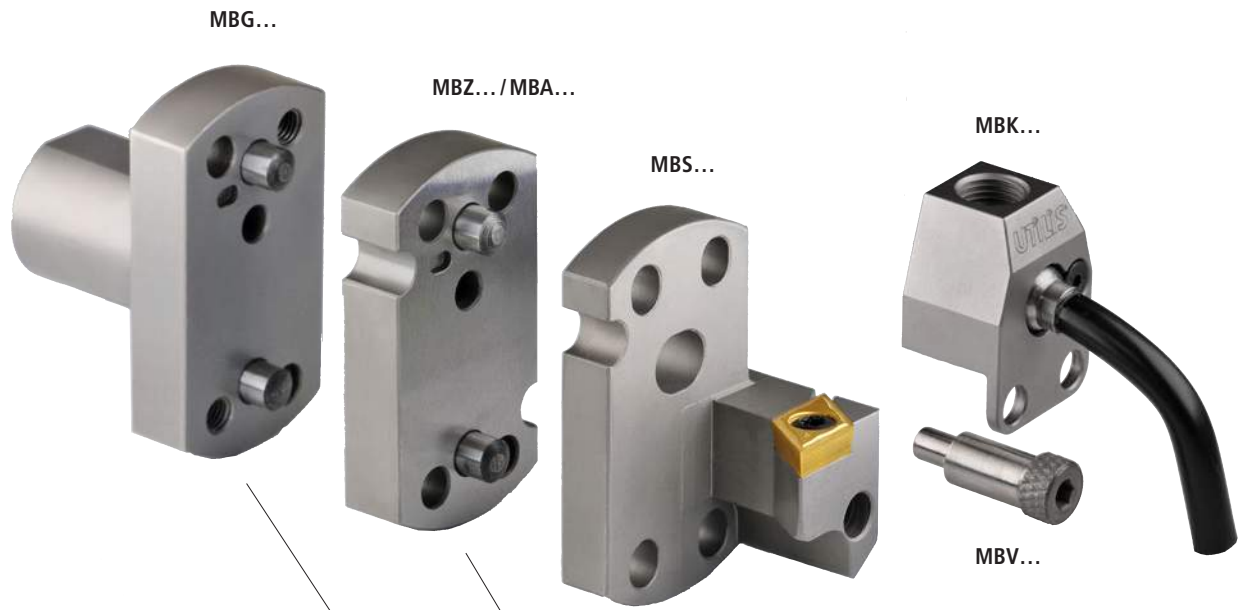

Compatibility overview

Basic tool holder	Spacer (optional)	Insert holder, collet holders and tool holders
MBG ... B02	MBZ ST 02-...	MBS ...02
MBG ... B05	MBZ ST 05-...	MBS ...05
MBG ... B06	MBZ ST 06-...	MBS ...06
MBG ... B90*	MBZ ST 90-...	MBS ...90

* Height not adjustable (only for machines with Y axis)

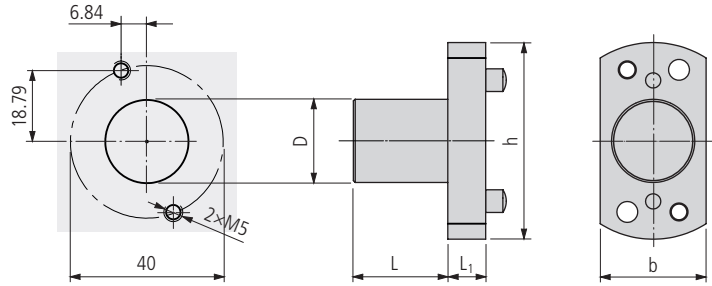

MBG 01 ... (HANWHA)

Type of machine	Order designation	Shape	Dimensions					
			D	L	b	h	L ₁	
XD 12H	MBG 01 2300 019 B02	■	23	19	28	49	16	
XD 32	MBG 01 3200 025 B90*	■	32	25	32.5	49	8	

* Height not adjustable

MBG 01 ... (STAR)

Type of machine	Order designation	Shape	Dimensions					
			D	L	b	h	L ₁	
SR10J/SR20R, ECAS 12/20, SR32J*	MBG 01 2200 025 B02	■	22	25	28	52	10	
	MBG 01 2200 025 B02 IC**	■	22	25	28	52	10	

* Valid from machine number ...161

** With internal cooling

Insert holder MBS ... 02/90 495
 Spacer MBZ ST 02/90-... 512

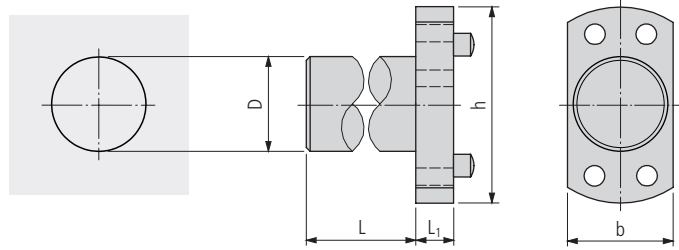

MBG 02 ... (CITIZEN)

Type of machine	Order designation		Dimensions					Shape
			D	L	b	h	L ₁	
R07	MBG 02 1587 040 B02	■	5/8" (15.875)	40	28	52	10	
C16, L20, M16	MBG 02 1905 060 B02	■	3/4" (19.05)	60	28	52	10	
K16	MBG 02 2000 100 B02	■	20	100	28	52	10	
L20	MBG 02 2500 060 B02	■	25	60	28	52	10	
C32, L32, M32	MBG 02 2540 070 B02	■	1" (25.4)	70	28	52	10	

478

MBG 02 ... (GILDEMEISTER)

Type of machine	Order designation		Dimensions					Shape
			D	L	b	h	L ₁	
Sprint20	MBG 02 2000 040 B02	■	20	40	28	52	10	

MBG 02 ... (HAMWHA)

Type of machine	Order designation		Dimensions					Shape
			D	L	b	h	L ₁	
SL12H	MBG 02 2000 040 B02	■	20	40	28	52	10	
STL32, STL35H, STL33J, STL35J	MBG 02 2500 060 B02	■	25	60	28	52	10	
SL26HPD, SL35HPD4SD32	MBG 02 2800 006 B02	■	28	6	28	52	10	
XD32	MBG 02 3200 025 B02	■	32	25	28	52	10	
XD20H, XD32H, XD20J, XD32J	MBG 02 3300 040 B02	■	33	40	35	52	10	
SL20HPII, SL26HPII, SL35HPII	MBG 02 3400 044 B02	■	34	44	35	52	10	

Insert holder MBS ... 02 □ 495
 Spacer MBZ ST 02-... □ 512

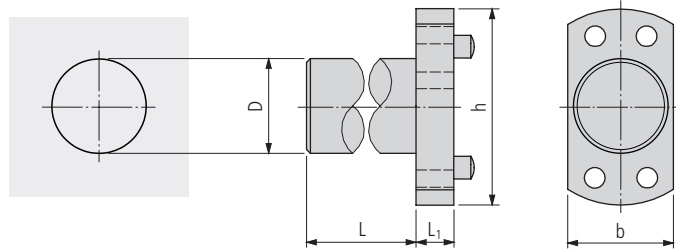

MBG 02 ... (MANURHIN)

Type of machine	Order designation		Dimensions					Shape
			D	L	b	h	L ₁	
EVO 7	MBG 02 2500 050 B02	■	25	50	28	52	10	
EVO 7*	MBG 02 2200 070 B02	■	22	70	28	52	10	
KMX 4/13	MBG 02 1600 019 B02	■	16	19	28	52	10	
KMX 5/20, KMX 5/26, KMX 5/32, Swing 7/20, Swing 7/26	MBG 02 2500 100 B02	■	25	100	28	52	10	
Swing 7-13	MBG 02 2000 100 B02	■	20	100	28	52	10	
Swing 10-20, Swing 10-26, Swing 10-32	MBG 02 2500 050 B02	■	25	50	28	52	10	

* Driven tool

MBG 02 ... (STAR)

Type of machine	Order designation		Dimensions					Shape
			D	L	b	h	L ₁	
RNC16B	MBG 02 1600 020 B02	■	16	20	28	52	10	
SA16, SB16	MBG 02 2200 070 B02	■	22	70	28	52	10	
SR10J	MBG 02 2200 015 B02	■	22	15	28	52	10	

MBG 02 ... (TORNOS)

Type of machine	Order designation		Dimensions					Shape
			D	L	b	h	L ₁	
DECO 7/10, DECO 13, DECO 20	MBG 02 2000 100 B02	■	20	100	28	52	10	
	MBG 02 2500 100 B02	■	25	100	28	52	10	
Delta 20, Gamma 20	MBG 02 2200 070 B02	■	22	70	28	52	10	
Delta 38-5a	MBG 02 3200 070 B02	■	32	70	32	52	10	
Gamma 20	MBG 02 2000 070 B02	■	20	70	28	52	10	

Insert holder MBS ... 02 495
 Spacer MBZ ST 02-... 512

Legend 8...

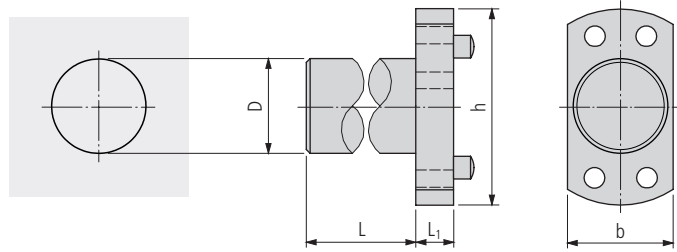

MBG 02 ... (TRAUB)

Type of machine	Order designation		Dimensions					Shape
			D	L	b	h	L ₁	
TNL12	MBG 02 2800 040 B02	■	28	40	28	52	10	
TNL/C 12, TNL/C 12K	MBG 02 2800 078 B02	■	28	78	28	52	10	

MBG 02 ... (TSUGAMI)

Type of machine	Order designation		Dimensions					Shape
			D	L	b	h	L ₁	
B012, B020, S205	MBG 02 2000 040 B02	■	20	40	28	52	10	
BS12, BS20	MBG 02 2000 060 B02	■	20	60	28	52	10	
BS20B	MBG 02 1587 040 B02	■	5/8" (15.875)	40	28	52	10	
Piastra	MBG 02 2500 035 B02	■	25	35	28	52	10	
S205	MBG 02 2000 030 B02	■	20	30	28	52	10	

Insert holder MBS ... 02 □ 495
 Spacer MBZ ST 02-... □ 512

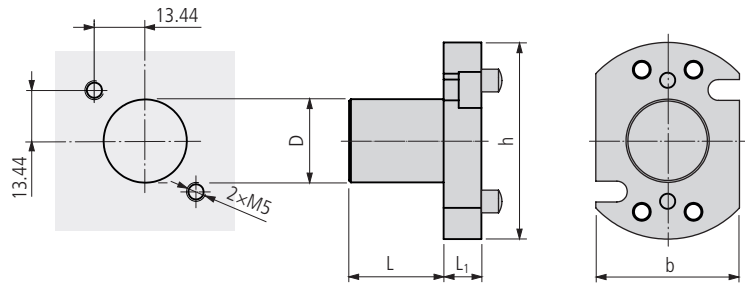

MBG 03 ... (CITIZEN)

Type of machine	Order designation	■	Dimensions					Shape
			D	L	b	h	L ₁	
A32-VII	MBG 03 3100 015 B02	■	31	15	38	52	10	

MBG 03 ... (STAR)

Type of machine	Order designation	■	Dimensions					Shape
			D	L	b	h	L ₁	
SR32, SR32J	MBG 03 2200 025 B02	■	22	25	38	52	10	

- Insert holder MBS ... 02 495
- Spacer MBZ ST 02-... 512

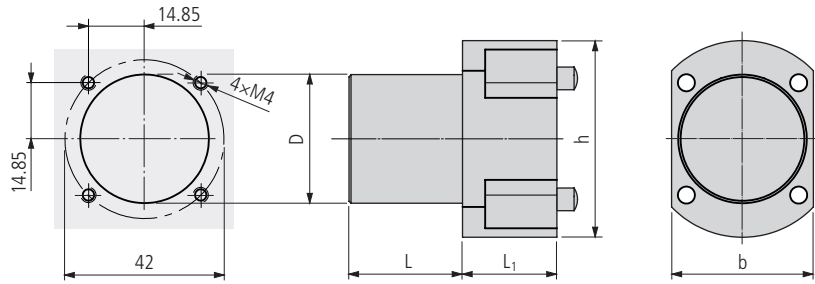

MBG 04 ... IC* (MAIER)

Type of machine	Order designation		Dimensions					Shape
			D	L	b	h	L ₁	
MLK DY36	MBG 04 3400 018 B02 IC*	■	34	18	38	52	25	
ML12C, ML16C, ML16D, ML20/26/32	MBG 04 3400 030 B02 IC*	■	34	30	38	52	25	

* With internal cooling

MBG 04 ... (STAR)

Type of machine	Order designation		Dimensions					Shape
			D	L	b	h	L ₁	
SV-38R, SR-38A/B	MBG 04 3400 025 B90*	■	34	25	37.5	52	8	

* Height not adjustable

- Insert holder MBS ... 02/90 □ 495
- Spacer MBZ ST 02/90-... □ 512

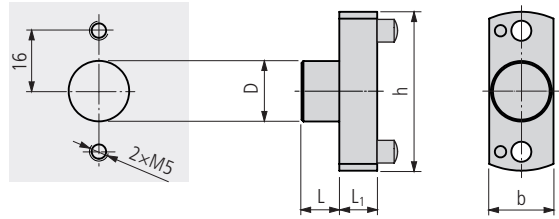

MBG 05 ... (HANWHA)

Type of machine	Order designation	■	Dimensions					Shape
			D	L	b	h	L ₁	
XD12H	MBG 05 1500 010 B05	■	15	10	17	51	10	

MBG 05 ... (STAR)

Type of machine	Order designation	■	Dimensions					Shape
			D	L	b	h	L ₁	
SR10J	MBG 05 1600 010 B05	■	16	10	17	51	10	

- Insert holder MBS ... 05 495
- Spacer MBZ ST 05-... 512

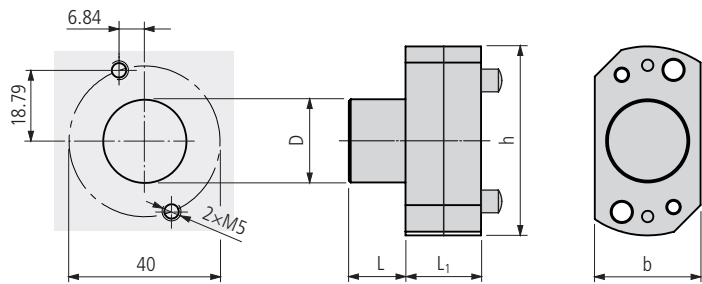

MBG 06 ... (STAR)

Type of machine	Order designation	■	Dimensions					Shape
			D	L	b	h	L ₁	
SR10J	MBG 06 2200 015 B06*	■	22	15	28	50	20	

* With adjusting sheet

- Insert holder MBS ... 06 495
- Spacer MBZ ST 06-... 512

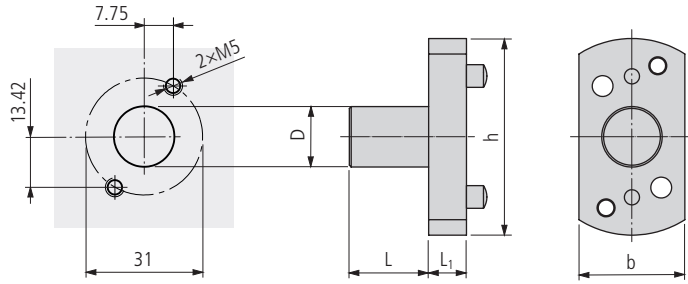

MBG 07 ... (STAR)

Type of machine	Order designation	■	Dimensions					Shape
			D	L	b	h	L ₁	
SR16, SR20	MBG 07 1600 021 B02	■	16	21	28	52	10	

Insert holder MBS ... 02 □ 495
 Spacer MBZ ST 02-... □ 512

484

UTILIS
multidec[®]
 SWISS type tools

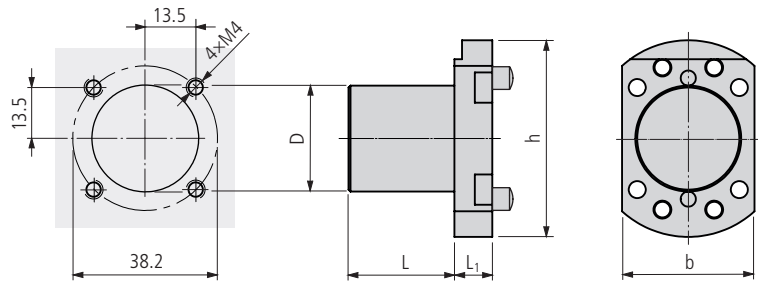

MBG 08 ... (TORNOS)

Type of machine	Order designation	■	Dimensions					Shape
			D	L	b	h	L ₁	
CT20	MBG 08 2800 028 B02	■	28	28	35	52	10	

Insert holder MBS ... 02 □ 495
 Spacer MBZ ST 02-... □ 512

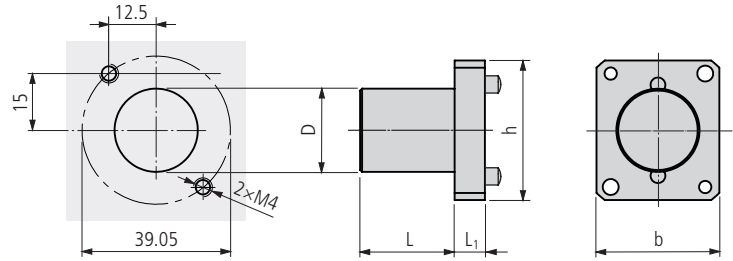

MBG 09 ... (HANWHA)

Type of machine	Order designation	Dimensions					Shape
		D	L	b	h	L ₁	
XDI 20	MBG 09 2500 050 B90*	25	50	32.5	37	8	

* Height not adjustable

MBG 09 ... (STAR)

Type of machine	Order designation	Dimensions					Shape
		D	L	b	h	L ₁	
SW-20, SR-20W	MBG 09 2200 025 B90*	22	25	32.5	37	8	

* Height not adjustable

MBG 09 ... (TSUGAMI)

Type of machine	Order designation	Dimensions					Shape
		D	L	b	h	L ₁	
BO 326 EII	MBG 09 2500 015 B90*	25	15	32.5	37	8	

* Height not adjustable

- Insert holder MBS ... 90 495
- Spacer MBZ ST 90-... 512

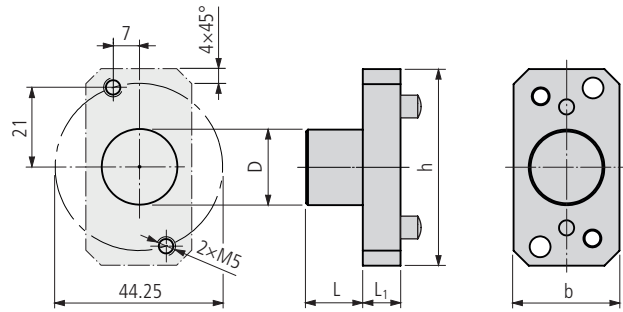

MBG 10 ... (STAR)

Type of machine	Order designation	■	Dimensions					Shape
			D	L	b	h	L ₁	
SR10J	MBG 10 2000 015 B02	■	20	15	28	52	10	

Insert holder MBS ... 02 □ 495
 Spacer MBZ ST 02-... □ 512

486

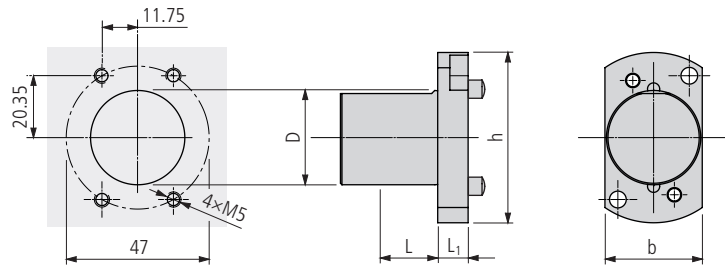

MBG 11 ... (CITIZEN)

Type of machine	Order designation	■	Dimensions					Shape
			D	L	b	h	L ₁	
L32	MBG 11 3100 032 B02	■	31	32	32	56	10	

Insert holder MBS ... 02 □ 495
 Spacer MBZ ST 02-... □ 512

UTILIS
multidec[®]
 swiss type tools

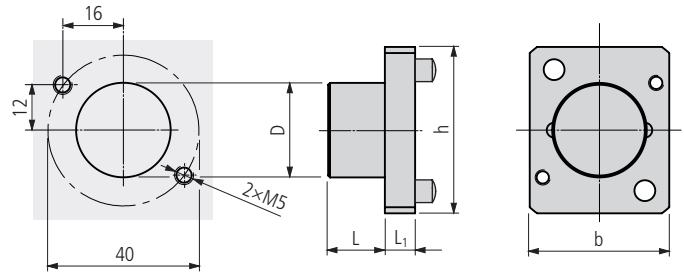

MBG 12 ... (TSUGAMI)

Type of machine	Order designation	Dimensions					Shape
		D	L	b	h	L ₁	
BO 266, BO 326	MBG 12 2500 015 B90*	25	15	44	36.9	8	

* Height not adjustable

- Insert holder MBS ... 90 495
- Spacer MBZ ST 90-... 512

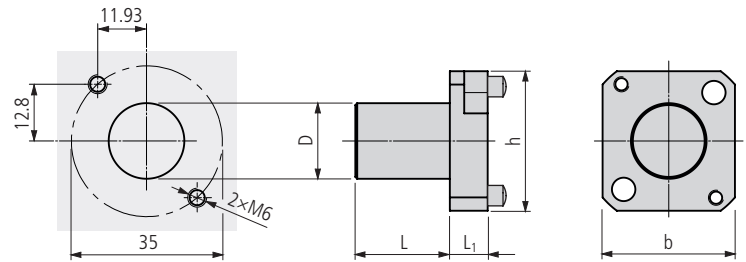

MBG 13 ... (TORNOS)

Type of machine	Order designation	Dimensions					Shape
		D	L	b	h	L ₁	
GT13, GT26	MBG 13 2000 025 B90*	20	25	36.9	36.9	20	

* Height not adjustable

- Insert holder MBS ... 90 495
- Spacer MBZ ST 90-... 512

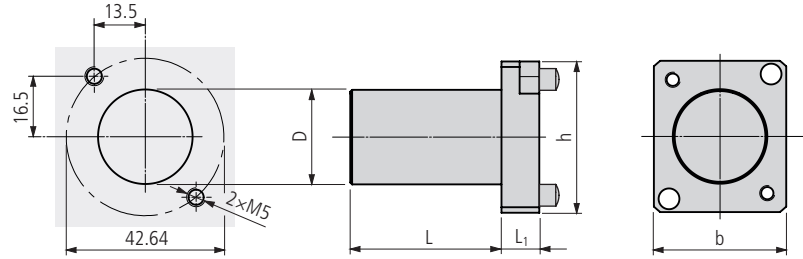

MBG 14 ... (NEXTURN)

Type of machine	Order designation		Dimensions					Shape
			D	L	b	h	L ₁	
SA 20XII	MBG 14 2500 040 B90*	■	25	40	35	40	10	
	MBG 14 2500 040 B90-30*	■	25	40	35	40	30	

* Height not adjustable

Insert holder MBS ... 90 □ 495
 Spacer MBZ ST 90-... □ 512

488

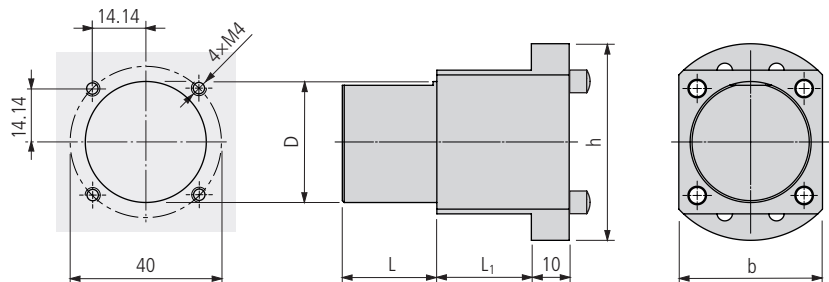

MBG 15 ... (HANWHA)

Type of machine	Order designation		Dimensions					Shape
			D	L	b	h	L ₁	
XD 38 H	MBG 15 3200 025 B02	■	32	25	38	52	35	
XD 38II Y2	MBG 15 3200 025 B90*	■	32	25	37.5	52	8	

* Height not adjustable

Insert holder MBS ... 02/90 □ 495
 Spacer MBZ ST 02/90-... □ 512

UTILIS
multidec[®]
 SWISS type tools



MBG 17 ... (TCM)

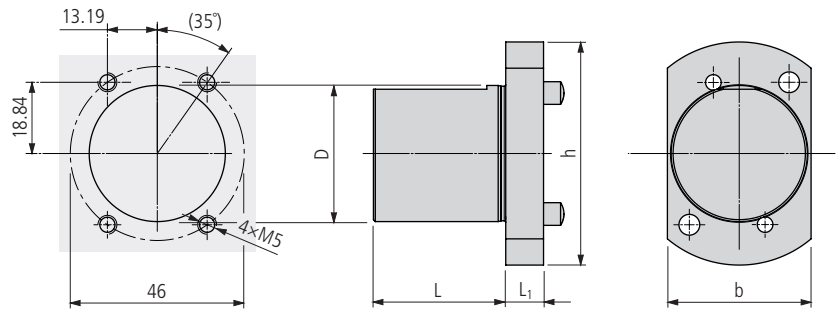

Type of machine	Order designation	Dimensions					Shape
		D	L	b	h	L ₁	
Series 20s/26s/32s/38s	MBG 17 3600 035 B02	36	35	38	59	10	

- Insert holder MBS ... 02 495
- Spacer MBZ ST 02-... 512

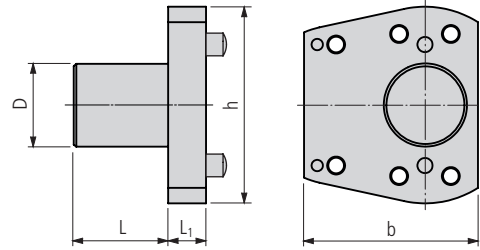
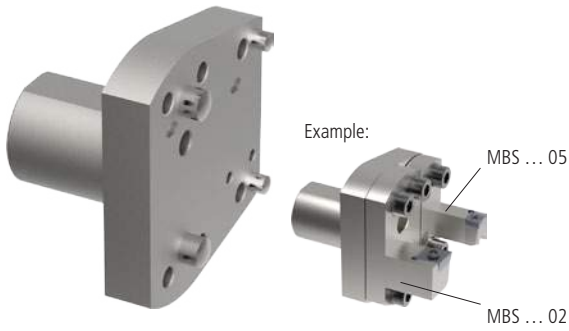

MBG 02 ... B02 05 (CITIZEN)

Type of machine	Order designation		Dimensions					Shape
			D	L	b	h	L ₁	
L720VII	MBG 02 1905 040 B02 05	■	¾" (19.05)	40	46	52	10	
	MBG 02 2000 040 B02 05	■	20	40	46	52	10	

MBG 02 ... B02 05 (STAR)

Type of machine	Order designation		Dimensions					Shape
			D	L	b	h	L ₁	
SR20R, SR20 RIV, SR32J*	MBG 02 2200 025 B02 05	■	22	25	46	52	10	
	MBG 02 2540 025 B02 05	■	1" (25.4)	25	46	52	10	

* Valid from machine number ...161

- Insert holder MBS ... 02/05 □ 495
- Spacer MBZ ST 02/05-... □ 512



MBG-T ... (STAR)

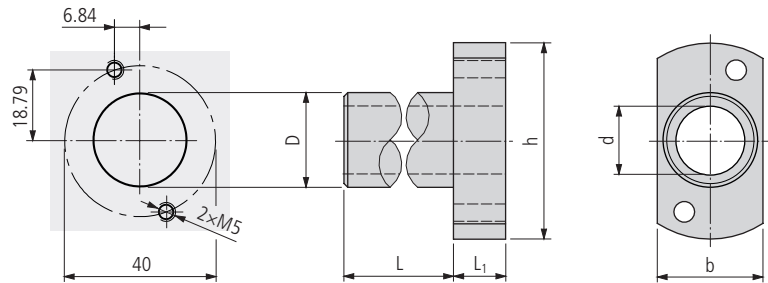

Type of machine	Order designation		Dimensions						Shape
			D	L	b	h	L ₁	d	
SA 16, SB 16, SR10J	MBG-T 10 2200 025 B01	■	22	25	28	52	15	10	
	MBG-T 16 2200 025 B01	■	22	25	28	52	15	16	



MBG-T ... (STAR)

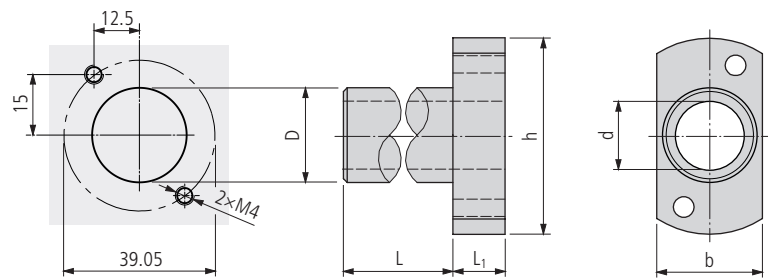

Type of machine	Order designation		Dimensions						Shape
			D	L	b	h	L ₁	d	
SA 16, SB 16, SR10J	MBG-T 16 2200 025 B09	■	22	25	33	52	15	16	

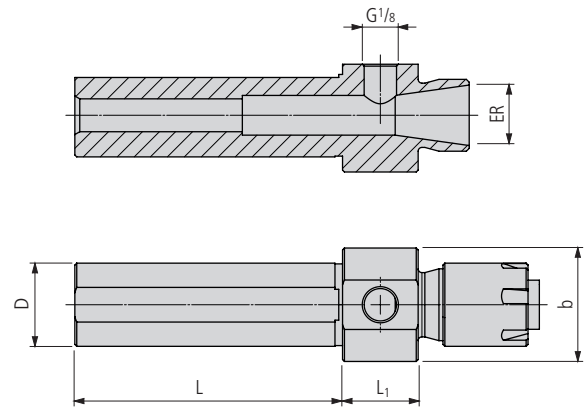

MBD 02 ...

Type of machine	Order designation		Dimensions						Shape
			D	L	b	L ₁	ER		
Miscellaneous	MBD 02 2200 080 E16 IC*	■	22	80	30	20	16		
	MBD 02 2200 080 E20 IC*	■	22	80	30	20	20		
	MBD 02 3200 080 E25 IC*	■	32	82	30	20	25		

* With internal cooling

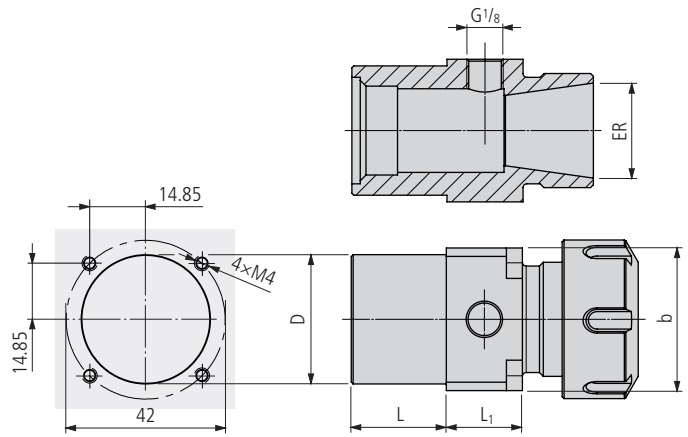

MBD ... E.. (STAR)

Type of machine	Order designation		Dimensions						Shape
			D	L	b	L ₁	ER		
SV-38R, SR-38A/B	MBD 04 3400 025 E25 IC*	■	34	25	37.5	20	25		

* With internal cooling

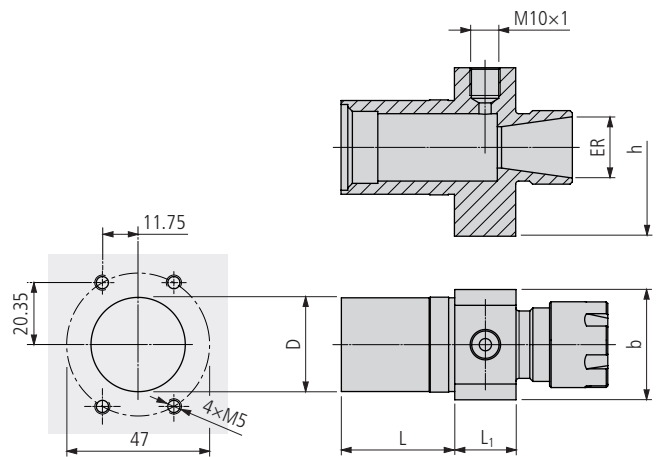

MBD ... E.. (CITIZEN)

Type of machine	Order designation		Dimensions						Shape
			D	L	b	h	L ₁	ER	
A32	MBD 11 3100 037 E20 IC*	■	31	37	36	58	20	20	
	MBD 11 3100 037 E25 IC*	■	31	37	36	58	20	25	

* With internal cooling

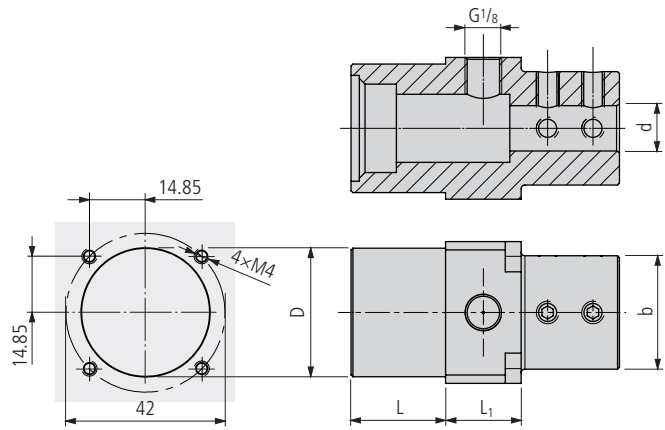

MBD 04 ... (STAR)

Type of machine	Order designation		Dimensions						Shape
			D	L	b	h	L ₁	d	
SV-38R, SR-38A/B	MBD 04 3400 025 D12 IC*	■	34	25	37.5	37.5	20	12	
	MBD 04 3400 025 D14 IC*	■	34	25	37.5	37.5	20	14	
	MBD 04 3400 025 D16 IC*	■	34	25	37.5	37.5	20	16	

* With internal cooling

494

UTILIS
multidec[®]
swiss type tools

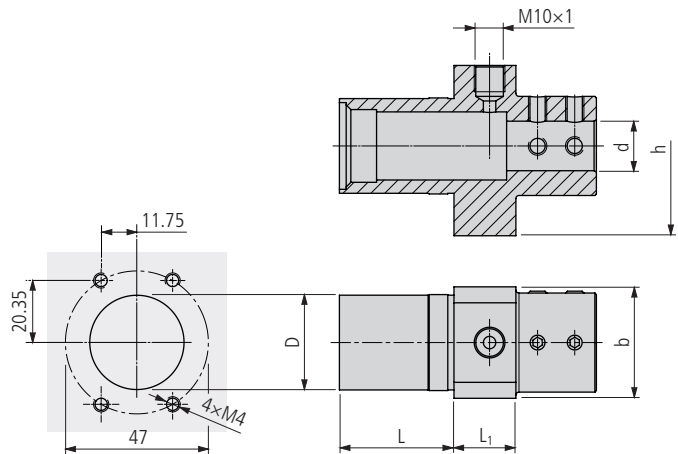

MBD 11 ... (CITIZEN)

Type of machine	Order designation		Dimensions						Shape
			D	L	b	h	L ₁	d	
A32	MBD 11 3100 037 D12*	■	31	37	36	58	20	12	
	MBD 11 3100 037 D14*	■	31	37	36	58	20	14	
	MBD 11 3100 037 D16*	■	31	37	36	58	20	16	
	MBD 11 3100 037 D20*	■	31	37	36	58	20	20	
	MBD 11 3100 037 D25*	■	31	37	36	58	20	25	

* With internal cooling

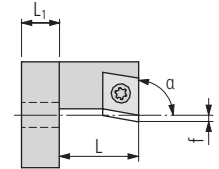
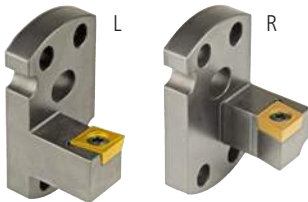

MBS ...-CC

Order designation				Dimensions				Basic tool holder	Spacer	Inserts
L	■	R	■	α	f	L	L ₁	MBG...	MBZ...	□ 177...
MBS 093-CC L 06 I02*	■	MBS 093-CC R 06 I02*	■	93°	–	20	8	MBG ... B02	MBZ ST 02-...	CC.. 0602...
		MBS 093-CC R 06 I02-30*	■	93°	–	30	8	MBG ... B02	MBZ ST 02-...	CC.. 0602...
MBS 090-CC L 09 I02*	■	MBS 090-CC R 09 I02*	■	90°	–	20	8	MBG ... B02	MBZ ST 02-...	CC.. 09T3...
		MBS 090-CC R 09 I02 IC**	■	90°	–	20	8	MBG ... B02	MBZ ST 02-...	CC.. 09T3...
MBS 093-CC L 09 I02*	■	MBS 093-CC R 09 I02*	■	93°	–	20	8	MBG ... B02	MBZ ST 02-...	CC.. 09T3...
MBS 093-CC L 09 I02-30*	■	MBS 093-CC R 09 I02-30*	■	93°	–	30	8	MBG ... B02	MBZ ST 02-...	CC.. 09T3...
MBS 095-CC L 09 I02*	■	MBS 095-CC R 09 I02*	■	95°	–	20	8	MBG ... B02	MBZ ST 02-...	CC.. 09T3...
MBS 093-CC L 06 I05*	■	MBS 093-CC R 06 I05*	■	93°	–	20	8	MBG ... B05	MBZ ST 05-...	CC.. 0602...
MBS 095-CC L 09 I05*	■	MBS 095-CC R 09 I05*	■	95°	–	20	8	MBG ... B05	MBZ ST 05-...	CC.. 09T3...
		MBS 090-CC R 06 I90	■	90°	-5	20	7	MBG ... B90	MBZ ST 90-...	CC.. 0602...
		MBS 090-CC R 09 I90	■	90°	–	20	7	MBG ... B90	MBZ ST 90-...	CC.. 09T3...
		MBS 090-CC R 09 I90-30	■	90°	–	30	7	MBG ... B90	MBZ ST 90-...	CC.. 09T3...

* Setting the centre height with adjustment excenter MBV E04

** With internal cooling

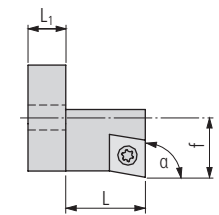
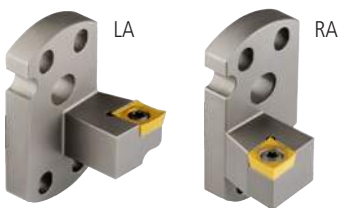

MBS ...-CC .A

Order designation				Dimensions				Basic tool holder	Spacer	Inserts
L	■	R	■	α	f	L	L ₁	MBG...	MBZ...	□ 177...
MBS 090-CC LA 09 I02*	■	MBS 090-CC RA 09 I02*	■	90°	18	20	8	MBG ... B02	MBZ ST 02-...	CC.. 09T3...
MBS 093-CC LA 06 I02*	■	MBS 093-CC RA 06 I02*	■	93°	18	20	8	MBG ... B02	MBZ ST 02-...	CC.. 0602...
MBS 093-CC LA 09 I02*	■	MBS 093-CC RA 09 I02*	■	93°	18	20	8	MBG ... B02	MBZ ST 02-...	CC.. 09T3...
MBS 093-CC LA 09 I02-30*	■	MBS 093-CC RA 09 I02-30*	■	93°	18	20	8	MBG ... B02	MBZ ST 02-...	CC.. 09T3...
MBS 095-CC LA 09 I02*	■	MBS 095-CC RA 09 I02*	■	95°	18	20	8	MBG ... B02	MBZ ST 02-...	CC.. 09T3...
MBS 093-CC LA 06 I05*	■	MBS 093-CC RA 06 I05*	■	93°	12.5	20	8	MBG ... B05	MBZ ST 05-...	CC.. 0602...
MBS 095-CC LA 09 I05*	■	MBS 095-CC RA 09 I05*	■	95°	12.5	20	8	MBG ... B05	MBZ ST 05-...	CC.. 09T3...
		MBS 090-CC RA 09 I90	■	90°	17	20	7	MBG ... B90	MBZ ST 90-...	CC.. 09T3...
MBS 095-CC LA 09 I90	■		■	95°	16.25	20	7	MBG ... B90	MBZ ST 90-...	CC.. 09T3...

* Setting the centre height with adjustment excenter MBV E04

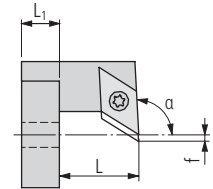
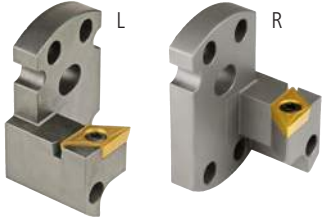
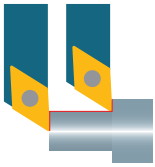

MBS ...-DC

Order designation				Dimensions				Basic tool holder	Spacer	Inserts
L	Color	R	Color	α	f	L	L ₁	MBG...	MBZ...	□201...
MBS 093-DC L 0703 I02*	■	MBS 093-DC R 0703 I02*	■	93°	–	20	8	MBG ... B02	MBZ ST 02-...	DC.. 0703...
MBS 093-DC L 11 I02*	■	MBS 093-DC R 11 I02*	■	93°	–	20	8	MBG ... B02	MBZ ST 02-...	DC.. 11T3...
		MBS 093-DC R 11 I02 IC**	■	93°	–	20	8	MBG ... B02 IC	MBZ ST 02-... IC	DC.. 11T3...
MBS 093-DC L 11 I02-30*	■	MBS 093-DC R 11 I02-30*	■	93°	–	30	8	MBG ... B02	MBZ ST 02-...	DC.. 11T3...
MBS 093-DC L 11 I02-40*	■	MBS 093-DC R 11 I02-40*	■	93°	–	40	8	MBG ... B02	MBZ ST 02-...	DC.. 11T3...
MBS 093-DC L 07 I05*	■	MBS 093-DC R 07 I05*	■	93°	–	20	8	MBG ... B05	MBZ ST 05-...	DC.. 0702...
MBS 093-DC L 11 I06*	■	MBS 093-DC R 11 I06*	■	93°	–	20	8	MBG ... B06	MBZ ST 06-...	DC.. 11T3...
MBS 093-DC L 07 I90	■	MBS 093-DC R 07 I90	■	93°	-2.25	20	7	MBG ... B90	MBZ ST 90-...	DC.. 0702...
MBS 093-DC L 11 I90	■	MBS 093-DC R 11 I90	■	93°	–	20	7	MBG ... B90	MBZ ST 90-...	DC.. 11T3...
MBS 093-DC L 11 I90-30	■	MBS 093-DC R 11 I90-30	■	93°	–	30	7	MBG ... B90	MBZ ST 90-...	DC.. 11T3...
		MBS 093-DC R 11 I90-40	■	93°	–	40	7	MBG ... B90	MBZ ST 90-...	DC.. 11T3...

* Setting the centre height with adjustment excenter MBV E04
 ** With internal cooling

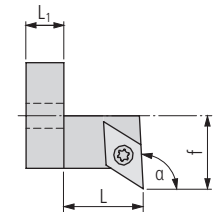
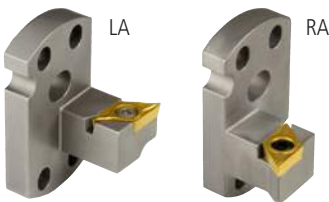

MBS ...-DC .A

Order designation				Dimensions				Basic tool holder	Spacer	Inserts
L	Color	R	Color	α	f	L	L ₁	MBG...	MBZ...	□201...
MBS 093-DC LA 0703 I02*	■	MBS 093-DC RA 0703 I02*	■	93°	18	20	8	MBG ... B03	MBZ ST 02-...	DC.. 0703...
MBS 093-DC LA 11 I02*	■	MBS 093-DC RA 11 I02*	■	93°	18	20	8	MBG ... B02	MBZ ST 02-...	DC.. 11T3...
MBS 093-DC LA 11 I02-30*	■	MBS 093-DC RA 11 I02-30*	■	93°	18	30	8	MBG ... B02	MBZ ST 02-...	DC.. 11T3...
MBS 093-DC LA 11 I02-40*	■	MBS 093-DC RA 11 I02-40*	■	93°	18	40	8	MBG ... B02	MBZ ST 02-...	DC.. 11T3...
MBS 095-DC LA 11 I02*	■			95°	18	20	8	MBG ... B02	MBZ ST 02-...	DC.. 11T3...
MBS 093-DC LA 07 I05*	■	MBS 093-DC RA 07 I05*	■	93°	8.5	20	8	MBG ... B05	MBZ ST 05-...	DC.. 0702...
MBS 093-DC LA 11 I06*	■	MBS 093-DC RA 11 I06*	■	93°	18	20	8	MBG ... B06	MBZ ST 06-...	DC.. 11T3...
MBS 093-DC LA 07 I90	■	MBS 093-DC RA 07 I90	■	93°	17	20	7	MBG ... B90	MBZ ST 90-...	DC.. 0702...
MBS 093-DC LA 07 I90-30	■	MBS 093-DC RA 07 I90-30	■	93°	17	30	7	MBG ... B90	MBZ ST 90-...	DC.. 0702...
MBS 093-DC LA 11 I90	■	MBS 093-DC RA 11 I90	■	93°	17	20	7	MBG ... B90	MBZ ST 90-...	DC.. 11T3...
MBS 093-DC LA 11 I90-30	■	MBS 093-DC RA 11 I90-30	■	93°	17	30	7	MBG ... B90	MBZ ST 90-...	DC.. 11T3...
		MBS 093-DC RA 11 I90-40	■	93°	17	40	7	MBG ... B90	MBZ ST 90-...	DC.. 11T3...

* Setting the centre height with adjustment excenter MBV E04

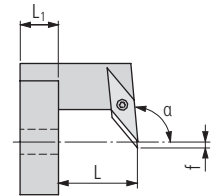
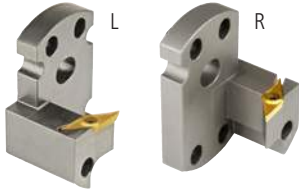
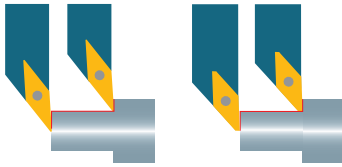

MBS ...-VC

Order designation				Dimensions				Basic tool holder	Spacer	Inserts
L		R		α	f	L	L ₁	MBG...	MBZ...	□ 259...
MBS 110-VB L 11 I02*	■	MBS 110-VB R 11 I02*	■	110°	—	20	8	MBG ... B02	MBZ ST 02-...	VB.. 1102...
MBS 0725-VC L 11 I02*	■	MBS 0725-VC R 11 I02*	■	72.5°	—	20	8	MBG ... B02	MBZ ST 02-...	VC.. 1103...
MBS 093-VC L 07 I02*	■	MBS 093-VC R 07 I02*	■	93°	—	20	8	MBG ... B02	MBZ ST 02-...	VC.. 0702...
MBS 093-VC L 11 I02*	■	MBS 093-VC R 11 I02*	■	93°	—	20	8	MBG ... B02	MBZ ST 02-...	VC.. 1103...
MBS 093-VC L 11 I02-30*	■	MBS 093-VC R 11 I02-30*	■	93°	—	30	8	MBG ... B02	MBZ ST 02-...	VC.. 1103...
		MBS 093-VC R 11 I02-40*	■	93°	—	40	8	MBG ... B02	MBZ ST 02-...	VC.. 1103...
MBS 093-VC L 12 I02*	■	MBS 093-VC R 12 I02*	■	93°	—	20	8	MBG ... B02	MBZ ST 02-...	VC.. 1203...
MBS 093-VC L 13 I02*	■	MBS 093-VC R 13 I02*	■	93°	—	20	8	MBG ... B02	MBZ ST 02-...	VC.. 1303...
MBS 095-VC L 07 I02*	■	MBS 095-VC R 07 I02*	■	95°	—	20	8	MBG ... B02	MBZ ST 02-...	VC.. 0702...
MBS 095-VC L 11 I02*	■	MBS 095-VC R 11 I02*	■	95°	—	20	8	MBG ... B02	MBZ ST 02-...	VC.. 1103...
MBS 095-VC L 11 I02-40*	■	MBS 095-VC R 11 I02-40*	■	95°	—	40	8	MBG ... B02	MBZ ST 02-...	VC.. 1103...
MBS 110-VC L 11 I02*	■	MBS 110-VC R 11 I02*	■	110°	—	20	8	MBG ... B02	MBZ ST 02-...	VC.. 1103...
MBS 1175-VC L 11 I02*	■	MBS 1175-VC R 11 I02*	■	117.5°	—	20	8	MBG ... B02	MBZ ST 02-...	VC.. 1103...
MBS 1175-VC L 12 I02*	■	MBS 1175-VC R 12 I02*	■	117.5°	—	20	8	MBG ... B02	MBZ ST 02-...	VC.. 1203...
MBS 1175-VC L 13 I02*	■	MBS 1175-VC R 13 I02*	■	117.5°	—	23	8	MBG ... B02	MBZ ST 02-...	VC.. 1303...
MBS 140-VC L 11 I02*	■	MBS 140-VC R 11 I02*	■	140°	—	23	8	MBG ... B02	MBZ ST 02-...	VC.. 1103...
		MBS 1625-VC N 11 I02*	■	162.5°	—	25	8	MBG ... B02	MBZ ST 02-...	VC.. 1103...
MBS 093-VC L 07 I05*	■	MBS 093-VC R 07 I05*	■	93°	—	20	8	MBG ... B05	MBZ ST 05-...	VC.. 0702...
MBS 093-VC L 07 I90	■	MBS 093-VC R 07 I90	■	93°	—	20	7	MBG ... B90	MBZ ST 90-...	VC.. 0702...
MBS 093-VC L 11 I90	■	MBS 093-VC R 11 I90	■	93°	2.25	20	8	MBG ... B90	MBZ ST 90-...	VC.. 1103...
MBS 093-VC L 12 I90	■	MBS 093-VC R 12 I90	■	93°	6	20	7	MBG ... B90	MBZ ST 90-...	VC.. 1203...
MBS 095-VC L 11 I90	■	MBS 095-VC R 11 I90	■	95°	2.25	20	7	MBG ... B90	MBZ ST 90-...	VC.. 1103...
MBS 095-VC L 11 I90-30	■	MBS 095-VC R 11 I90-30	■	95°	—	30	7	MBG ... B90	MBZ ST 90-...	VC.. 1103...
MBS 095-VC L 11 I90 IC**	■	MBS 095-VC R 11 I90 IC**	■	95°	2.25	20	7	MBG ... B90	MBZ ST 90-...	VC.. 1103...
MBS 095-VC L 12 I90	■	MBS 095-VC R 12 I90	■	95°	6	20	7	MBG ... B90	MBZ ST 90-...	VC.. 1203...
		MBS 110-VC R 11 I90	■	110°	—	20	7	MBG ... B90	MBZ ST 90-...	VC.. 1103...
		MBS 1625-VC N 11 I90	■	162.5°	—	24	7	MBG ... B90	MBZ ST 90-...	VC.. 1103...

* Setting the centre height with adjustment excenter MBV E04

** With internal cooling

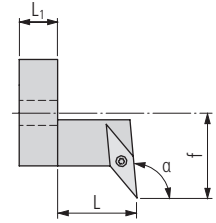
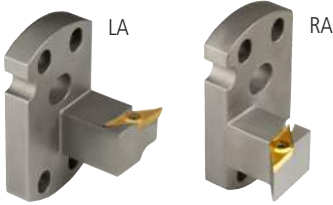
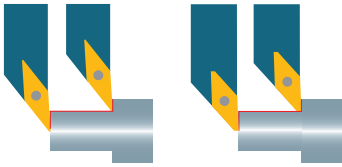

MBS ...-VC .A

Order designation				Dimensions				Basic tool holder	Spacer	Inserts
L	Color	R	Color	α	f	L	L ₁	MBG...	MBZ...	□259...
MBS 0725-VC LA 11 I02*	■	MBS 0725-VC RA 11 I02*	■	72.5°	18	25	8	MBG ... B02	MBZ ST 02-...	VC.. 1103...
MBS 093-VC LA 11 I02*	■	MBS 093-VC RA 11 I02*	■	93°	18	20	8	MBG ... B02	MBZ ST 02-...	VC.. 1103...
MBS 093-VC LA 11 I02-30*	■	MBS 093-VC RA 11 I02-30*	■	93°	18	30	8	MBG ... B02	MBZ ST 02-...	VC.. 1103...
MBS 093-VC LA 11 I02-40*	■			93°	18	40	8	MBG ... B02	MBZ ST 02-...	VC.. 1103...
MBS 093-VC LA 12 I02*	■	MBS 093-VC RA 12 I02*	■	93°	18	20	8	MBG ... B02	MBZ ST 02-...	VC.. 1203...
MBS 093-VC LA 13 I02*	■	MBS 093-VC RA 13 I02*	■	93°	18	20	8	MBG ... B02	MBZ ST 02-...	VC.. 1203...
MBS 095-VC LA 07 I02*	■			95°	18	20	8	MBG ... B02	MBZ ST 02-...	VC.. 0702...
MBS 095-VC LA 11 I02*	■	MBS 095-VC RA 11 I02*	■	95°	18	20	8	MBG ... B02	MBZ ST 02-...	VC.. 1103...
MBS 095-VC LA 11 I02-40*	■	MBS 095-VC RA 11 I02-40*	■	95°	18	40	8	MBG ... B02	MBZ ST 02-...	VC.. 1103...
MBS 110-VC LA 11 I02*	■	MBS 110-VC RA 11 I02*	■	110°	18	20	8	MBG ... B02	MBZ ST 02-...	VC.. 1103...
MBS 1175-VC LA 11 I02*	■	MBS 1175-VC RA 11 I02*	■	117.5°	18	20	8	MBG ... B02	MBZ ST 02-...	VC.. 1103...
MBS 1175-VC LA 12 I02*	■	MBS 1175-VC RA 12 I02*	■	117.5°	18	20	8	MBG ... B02	MBZ ST 02-...	VC.. 1203...
MBS 1175-VC LA 13 I02*	■	MBS 1175-VC RA 13 I02*	■	117.5°	18	23	8	MBG ... B02	MBZ ST 02-...	VC.. 1303...
MBS 140-VC LA 11 I02*	■	MBS 140-VC RA 11 I02*	■	140°	18	23	8	MBG ... B02	MBZ ST 02-...	VC.. 1103...
MBS 093-VC LA 07 I90	■	MBS 093-VC RA 07 I90	■	93°	17	20	7	MBG ... B90	MBZ ST 90-...	VC.. 0702...
MBS 093-VC LA 11 I90	■	MBS 093-VC RA 11 I90	■	93°	17	20	7	MBG ... B90	MBZ ST 90-...	VC.. 1103...
MBS 093-VC LA 13 I90	■			93°	17	20	7	MBG ... B90	MBZ ST 90-...	VC.. 1303...

* Setting the centre height with adjustment excenter MBV E04

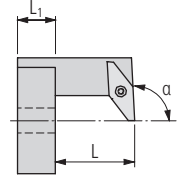
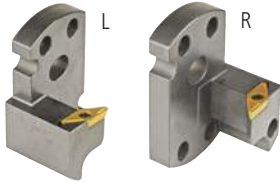
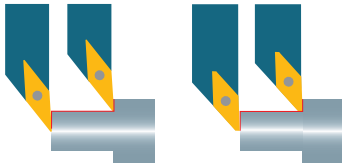

MBS ...-VP

Order designation				Dimensions				Basic tool holder	Spacer	Inserts
L		R		α	L	L ₁	MBG...	MBZ...	□305...	
MBS 093-VP L 10 I02*	■	MBS 093-VP R 10 I02*	■	93°	20	8	MBG ... B02	MBZ ST 02- ...	VP.. 1003...	
MBS 093-VP L 10 I90	■	MBS 093-VP R 10 I90	■	93°	20	7	MBG ... B90	MBZ ST 90- ...	VP.. 1003...	

* Setting the centre height with adjustment excenter MBV E04

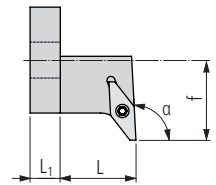
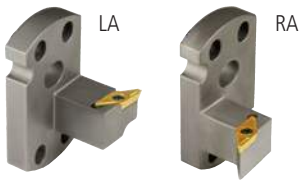

MBS ...-VP .A

Order designation				Dimensions				Basic tool holder	Spacer	Inserts
L		R		α	f	L	L ₁	MBG...	MBZ...	□305...
MBS 093-VP LA 10 I02*	■	MBS 093-VP RA 10 I02*	■	93°	28	20	8	MBG ... B02	MBZ ST 02- ...	VP.. 1003...
MBS 093-VP LA 10 I90	■	MBS 093-VP RA 10 I90	■	93°	17	20	7	MBG ... B90	MBZ ST 90- ...	VP.. 1003...

* Setting the centre height with adjustment excenter MBV E04

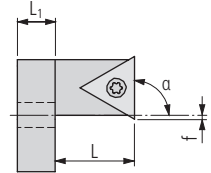
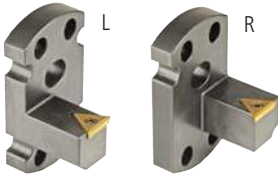

MBS ...-TC

Order designation				Dimensions				Basic tool holder	Spacer	Inserts
L		R		α	f	L	L ₁	MBG...	MBZ...	
MBS 090-TC L 11 I02*	■	MBS 090-TC R 11 I02*	■	90°	–	20	8	MBG ... B02	MBZ ST 02-...	TC.. 1102...
MBS 090-TP L 11 I02*	■	MBS 090-TP R 11 I02*	■	90°	–	20	8	MBG ... B02	MBZ ST 02-...	TP.. 1102...
		MBS 093-TC R 11 I02*	■	93°	15	20	8	MBG ... B02	MBZ ST 02-...	TC.. 1102...
		MBS 090-TC R 11 I90	■	90°	–	20	7	MBG ... B90	MBZ ST 90-...	TC.. 1102...

* Setting the centre height with adjustment excenter MBV E04

500

UTILIS **multidec**®
swiss type tools

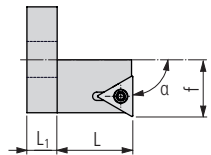
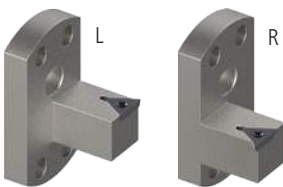

MBS ...-TC .A

Order designation				Dimensions				Basic tool holder	Spacer	Inserts
L		R		α	f	L	L ₁	MBG...	MBZ...	
MBS 090-TC LA 11 I02*	■	MBS 090-TC RA 11 I02*	■	90°	15	20	8	MBG ... B02	MBZ ST 02-...	TC.. 1102...
MBS 090-TP LA 11 I02*	■	MBS 090-TP RA 11 I02*	■	90°	15	20	8	MBG ... B02	MBZ ST 02-...	TP.. 1102...

* Setting the centre height with adjustment excenter MBV E04

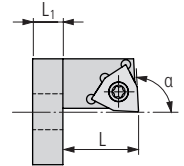
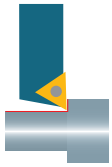

MBS ...-W0134

Order designation				Dimensions				Basic tool holder	Spacer	Inserts
L		R		α	L	L ₁	MBG...	MBZ...		
MBS 093-W0134 L I02*	■	MBS 093-W0134 R I02*	■	93°	20	8	MBG ... B02	MBZ ST 02-...	W0134...	
		MBS 093-W0134 R I02 IC***	■	93°	20	8	MBG ... B02	MBZ ST 02-...	W0134...	

* Setting the centre height with adjustment excenter MBV E04
 ** With internal cooling

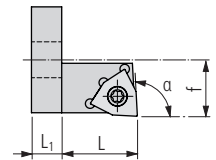
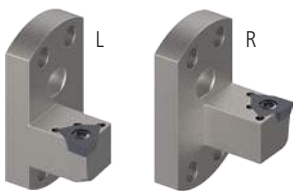

MBS ...-W0134 .A

Order designation				Dimensions				Basic tool holder	Spacer	Inserts
L		R		α	f	L	L ₁	MBG...	MBZ...	
MBS 093-W0134 LA I02*	■	MBS 093-W0134 RA I02*	■	93°	18	20	8	MBG ... B02	MBZ ST 02-...	W0134...

* Setting the centre height with adjustment excenter MBV E04

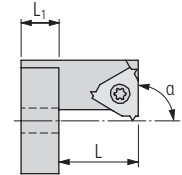

MBS ...-16 ER (VARGUS/ISCAR)

Order designation				Dimensions				Basic tool holder	Spacer	Inserts
L	■	R	■	α	L	L ₁	MBG...	MBZ...		
										MBG ... B02
MBG ... B02	MBZ ST 02-...	16EL								
MBG ... B02	MBZ ST 02-...	16EL								
MBG ... B02	MBZ ST 02-...	16ER								
MBG ... B02	MBZ ST 02-...	16ER								
MBG ... B02	MBZ ST 02-...	16ER								
MBG ... B90	MBZ ST 90-...	16ER								
MBG ... B90	MBZ ST 90-...	16ER								

* Setting the centre height with adjustment excenter MBV E04

502

UTILIS **multidec**® swiss type tools

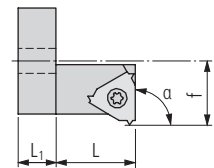

MBS ...-16 ER .A (VARGUS/ISCAR)

Order designation				Dimensions				Basic tool holder	Spacer	Inserts
L	■	R	■	α	f	L	L ₁	MBG...	MBZ...	
MBG ... B02	MBZ ST 02-...	16EL								
MBG ... B02	MBZ ST 02-...	16EL								
MBG ... B02	MBZ ST 02-...	16ER								
MBG ... B02	MBZ ST 02-...	16ER								
MBG ... B02	MBZ ST 02-...	16ER								
MBG ... B90	MBZ ST 90-...	16ER								
MBG ... B90	MBZ ST 90-...	16ER								

* Setting the centre height with adjustment excenter MBV E04

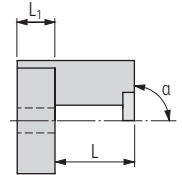
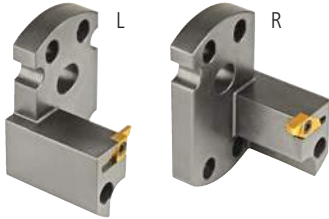
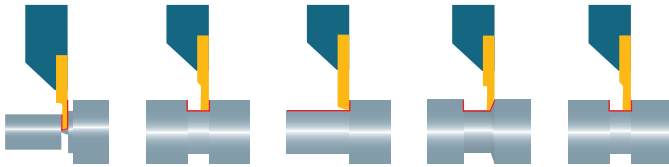

MBS ...-Cut ...

Order designation				Dimensions				Basic tool holder	Spacer	Inserts
L	■	R	■	α	L	L ₁	MBG...	MBZ...	□49...	
										MBS 090-Cut L 16 I02*
MBS 135-Cut L 16 I02*	■	MBS 135-Cut R 16 I02*	■	135°	23	8	MBG ... B02	MBZ ST 02- ...	16...	
MBS 090-Cut L 16 I05*	■	MBS 090-Cut R 16 I05*	■	90°	23	8	MBG ... B05	MBZ ST 05- ...	16...	
MBS 090-Cut L 16 I90	■	MBS 090-Cut R 16 I90	■	90°	23	7	MBG ... B90	MBZ ST 90- ...	16...	

* Setting the centre height with adjustment excenter MBV E04

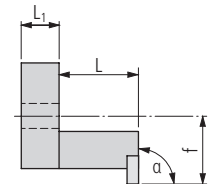
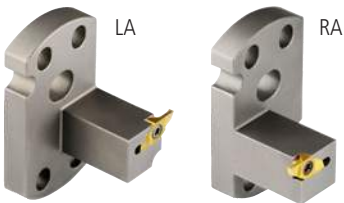

MBS ...-Cut .A ...

Order designation				Dimensions				Basic tool holder	Spacer	Inserts
L	■	R	■	α	f	L	L ₁	MBG...	MBZ...	□49...
MBS 135-Cut LA 16 I02*	■	MBS 135-Cut RA 16 I02*	■	135°	18.5	23	8	MBG ... B02	MBZ ST 02- ...	16...
MBS 090-Cut LA 16 I05*	■	MBS 090-Cut RA 16 I05*	■	90°	13	23	8	MBG ... B05	MBZ ST 05- ...	16...
MBS 090-Cut LA 16 I90	■	MBS 090-Cut RA 16 I90	■	90°	20.75	23	7	MBG ... B90	MBZ ST 90- ...	16...

* Setting the centre height with adjustment excenter MBV E04

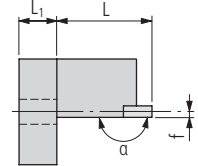
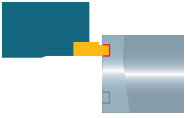

MBS 180-CUT ...

Order designation				Dimensions				Basic tool holder	Spacer	Inserts
L		R		α	f	L	L ₁	MBG...	MBZ...	□49...
				180°	1.5	20	8	MBG ... B02	MBZ ST 02- ...	16...
				180°	1.5	20	8	MBG ... B05	MBZ ST 05- ...	16...
				180°	1.5	20	7	MBG ... B90	MBZ ST 90- ...	16...

* Setting the centre height with adjustment excenter MBV E04

504

UTILIS
multidec[®]
swiss type tools

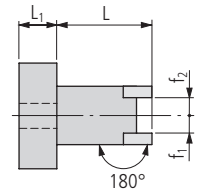

MBS 180-CUT ... twin .

Order designation				Dimensions				Basic tool holder	Spacer	Inserts
N				f ₁	f ₂	L	L ₁	MBG...	MBZ...	□49...
				-4.5	4.5	20	8	MBG ... B02	MBZ ST 02- ...	16...
				3	11	20	8	MBG ... B02	MBZ ST 02- ...	16...

* Setting the centre height with adjustment excenter MBV E04

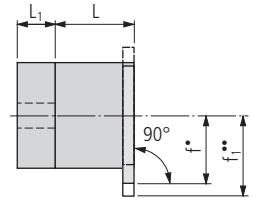
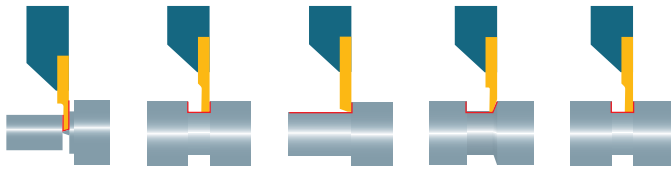

MBS 090-CUT N 30 ...

Order designation		Dimensions				Basic tool holder	Spacer	Inserts
		f	f ₁	L	L ₁			
								
	MBS 090-CUT N 30 I02*	■				MBG ... B02	MBZ ST 02- ...	30...
	MBS 090-CUT N 30 I90	■				MBG ... B90	MBZ ST 90- ...	30...

● Short insert; ●● Long insert

* Setting the centre height with adjustment excenter MBV E04

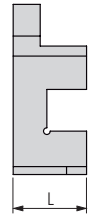

MBS 090 1212 ...

Order designation		Dimensions			Basic tool holder	Spacer	Holder	
L				L	MBG...	MBZ...		
	MBS 090 1212 T02*	■			22	MBG ... B02	MBZ ST 02- ...	12 × 12
	MBS 090 1212 T90	■			22	MBG ... B90	MBZ ST 90- ...	12 × 12

* Setting the centre height with adjustment excenter MBV E04



MBS TNMG ...

Order designation		Dimensions			Basic tool holder		Inserts
N			L ₂	L ₃	MBG...		
	MBS TNMG 0803	■	14	12	MBS 090 1212 ...		TNMG 0803

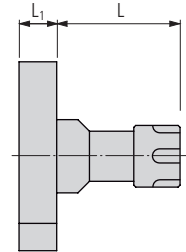

MBS E...

Order designation			Dimensions		Basic tool holder	Spacer	Type
			L	L ₁			
MBS E08 20 C02*	■		20	8	MBG ... B02	MBZ ST 02-...	ER08
MBS E08 30 C02*	■		30	8	MBG ... B02	MBZ ST 02-...	ER08
MBS E11 25 C02*	■		25	8	MBG ... B02	MBZ ST 02-...	ER11
MBS E11 35 C02*	■		35	8	MBG ... B02	MBZ ST 02-...	ER11
MBS E16 25 C02*	■		25	8	MBG ... B02	MBZ ST 02-...	ER16
MBS E16 35 C02*	■		35	8	MBG ... B02	MBZ ST 02-...	ER16
MBS E20 35 C02*	■		35	8	MBG ... B02	MBZ ST 02-...	ER20
MBS E20 45 C02*	■		45	8	MBG ... B02	MBZ ST 02-...	ER20
MBS E08 20 C05*	■		20	8	MBG ... B05	MBZ ST 05-...	ER08
MBS E08 30 C05*	■		30	8	MBG ... B05	MBZ ST 05-...	ER08
MBS E11 25 C05*	■		25	8	MBG ... B05	MBZ ST 05-...	ER11
MBS E11 35 C05*	■		35	8	MBG ... B05	MBZ ST 05-...	ER11
MBS E08 20 C06*	■		20	8	MBG ... B06	MBZ ST 06-...	ER08
MBS E08 30 C06*	■		30	8	MBG ... B06	MBZ ST 06-...	ER08
MBS E11 25 C06*	■		25	8	MBG ... B06	MBZ ST 06-...	ER11
MBS E11 35 C06*	■		35	8	MBG ... B06	MBZ ST 06-...	ER11
MBS E16 25 C06*	■		25	8	MBG ... B06	MBZ ST 06-...	ER16
MBS E16 35 C06*	■		35	8	MBG ... B06	MBZ ST 06-...	ER16
MBS E08 20 C90	■		20	7	MBG ... B90	MBZ ST 90-...	ER08
MBS E08 30 C90	■		30	7	MBG ... B90	MBZ ST 90-...	ER08
MBS E11 25 C90	■		25	7	MBG ... B90	MBZ ST 90-...	ER11
MBS E11 35 C90	■		35	7	MBG ... B90	MBZ ST 90-...	ER11
MBS E16 25 C90	■		25	7	MBG ... B90	MBZ ST 90-...	ER16
MBS E16 35 C90	■		35	7	MBG ... B90	MBZ ST 90-...	ER16
MBS E20 35 C90	■		35	7	MBG ... B90	MBZ ST 90-...	ER20
MBS E20 45 C90	■		45	7	MBG ... B90	MBZ ST 90-...	ER20

* Setting the centre height with adjustment excenter MBV E04

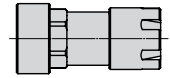
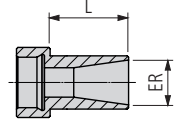

MBS V...

Order designation		Dimensions			Holder	Type
		L			MBS...	ER...
N						
MBS V11 30	■			28	MBS E11 ...	ER11
MBS V16 30	■			28	MBS E16 ...	ER16
MBS V20 30	■			28	MBS E20 ...	ER20



MBS SDA...

$$l = l_0 + 11$$

$$l_9 = l - l_2$$

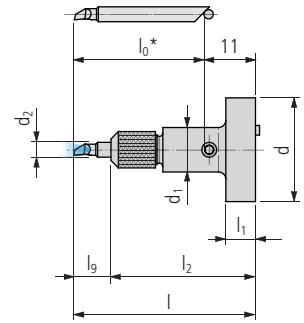

Order designation				Dimensions				Basic tool holder	Spacer	Inserts
N				d ₁	d ₂	L ₁	L ₂	MBG...	MBZ...	□ 335...
				MBS SDA4 IT02 IC*	■			12	4	8
MBS SDA6 IT02 IC*	■			15	6	8	38	MBG ... B02	MBZ ST 02-...	SD. 6... / SX. 6...
MBS SDA8 IT02 IC*	■			18	8	8	40	MBG ... B02	MBZ ST 02-...	SD. 8... / SX. 8...
MBS SDA4 IT05 IC*	■			12	4	8	35	MBG ... B05	MBZ ST 05-...	SD. 4... / SX. 4...
MBS SDA4 IT90 IC	■			12	4	7	35	MBG ... B90	MBZ ST 90-...	SD. 4... / SX. 4...
MBS SDA6 IT90 IC	■			15	6	7	38	MBG ... B90	MBZ ST 90-...	SD. 6... / SX. 6...
MBS SDA8 IT90 IC	■			18	8	7	40	MBG ... B90	MBZ ST 90-...	SD. 8... / SX. 8...

* Setting the centre height with adjustment excenter MBV E04

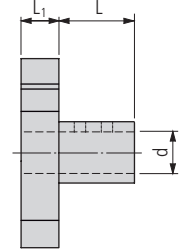

MBS ... IT..

Order designation				Dimensions			Basic tool holder	Spacer
N				d	L	L ₁	MBG...	MBZ...
				MBS 10 IT02*	■			10
MBS 12 IT02*	■			12	13	8	MBG ... B02	MBZ ST 02-...
MBS 14 IT02*	■			14	13	8	MBG ... B02	MBZ ST 02-...
MBS 10 IT05*	■			10	13	8	MBG ... B05	MBZ ST 05-...
MBS 10 IT90	■			10	14	7	MBG ... B90	MBZ ST 90-...
MBS 12 IT90	■			12	14	7	MBG ... B90	MBZ ST 90-...
MBS 14 IT90	■			14	14	7	MBG ... B90	MBZ ST 90-...
MBS 16 IT90	■			16	14	7	MBG ... B90	MBZ ST 90-...

* Setting the centre height with adjustment excenter MBV E04

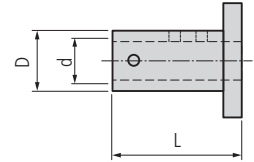

MBR ...

Order designation		Dimensions									
		D	d	L							
MBR D10-02	■	10	2	22							
MBR D10-03	■	10	3	22							
MBR D10-04	■	10	4	22							
MBR D10-05	■	10	5	22							
MBR D10-06	■	10	6	22							
MBR D10-07	■	10	7	22							
MBR D10-08	■	10	8	22							
MBR D12-04	■	12	4	22							
MBR D12-05	■	12	5	22							
MBR D12-06	■	12	6	22							
MBR D12-07	■	12	7	22							
MBR D12-08	■	12	8	22							
MBR D12-09	■	12	9	22							
MBR D12-10	■	12	10	22							
MBR L D12-06	■	12	6	30.85							
MBR L D12-08	■	12	8	30.85							
MBR L D12-10	■	12	10	30.85							
MBR L D16-10	■	16	10	30.85							
MBR L D16-12	■	16	12	30.85							
MBR L D16-14	■	16	14	30.85							



IC

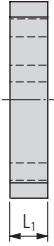

MBZ ...

Order designation		Dimensions				Basic tool holder MBG ...	Insert holder, collet holders and tool holders MBS ...
		L ₁					
MBZ ST 02-10*	■	10			MBG ... B02	MBS ... 02	
MBZ ST 02 10 02/05*	■	10			MBG ... B02	MBS ... 02/MBS ... 05	
MBZ ST 02-20*	■	20			MBG ... B02	MBS ... 02	
MBZ ST 02-20 IC**	■	20			MBG ... B02	MBS ... 02 IC	
MBZ ST 02-25*	■	25			MBG ... B02	MBS ... 02	
MBZ ST 02-25 IC**	■	25			MBG ... B02	MBS ... 02 IC	
MBZ ST 02-30*	■	30			MBG ... B02	MBS ... 02	
MBZ ST 02-30 IC**	■	30			MBG ... B02	MBS ... 02 IC	
MBS ST 05-10*	■	10			MBG ... B05	MBS ... 05	
MBZ ST 05-20*	■	20			MBG ... B05	MBS ... 05	
MBZ ST 90-10	■	10			MBG ... B90	MBS ... 90	
MBZ ST 90-20	■	20			MBG ... B90	MBS ... 90	
MBZ ST 90-20 IC**	■	20			MBG ... B90	MBS ... 90 IC	
MBZ ST 90-25 IC**	■	25			MBG ... B90	MBS ... 90 IC	
MBZ ST 90-30	■	30			MBG ... B90	MBS ... 90	

* Setting the centre height with adjustment excenter MBV E04

** With internal cooling

Matching allen head screws □ 515

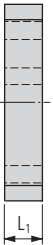

MBA ...

Order designation		Dimensions			Basic tool holder	Insert holder, collet holders and tool holders
		L ₁			MBG...	MBS...
MBA 02-05	■	10			MBG ... B02	MBS ... 05
MBA 06-02*	■	10			MBG ... B06	MBS ... 02

* Included with basic holders MBG ... B06

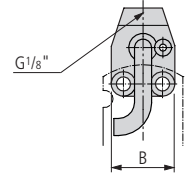

MBK Cool Flex

Order designation		Dimensions		Basic tool holder	Spacer	Insert holder, collet holders and tool holders
		B		MBG...	MBZ...	MBS...
	MBK Cool Flex	■	22.3	MBG ... B02	MBZ ST 02-...	MBS ...02

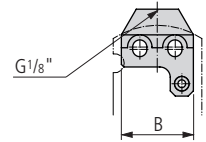

MBK Cool Fix

Order designation		Dimensions		Basic tool holder	Spacer	Insert holder, collet holders and tool holders	
		B		MBG...	MBZ...	MBS...	
		MBK Cool Fix L	■	MBK Cool Fix R	■	28	MBG ... B02

Illustration	Description	Dimensions	Order designation	Inserts	
	Adjustment excenter		MBV E04	■	
	Adjustment excenter mini		MBV E05	■	
	TORX screw	M2.5 × 6 T08	MSP 25060 T08	■	CC06, DC07, TC11, VC11, VP10, 1600...
		M2.5 × 7 T08	MSP 25070 T08	■	1600... 4
		M2.5 × 9 T08	MSP 25090 T08	■	1600... 6 1600... 8
		M3 × 7.3 T08	MSP 30073 T08	■	3000-08... 3000...A
		M3 × 9 T08	MSP 30090 T08	■	3000...
		M3.5 × 11 T15	MSP 35110T15	■	CC09, DC11
		M3 × 12 T10	MSP UNC 540120T10	■	16EL/ER...
	Shim screw		MSP UNC 540070 T10	■	16EL/ER...
	Anvil		YE3	■	16EL/ER...
	Socket head screw	M4 × 12 DIN912	MSP M412	■	
		M4 × 20 DIN912	MSP M420	■	
		M4 × 35 DIN912	MSP M435	■	
		M4 × 40 DIN912	MSP M440	■	
		M4 × 45 DIN912	MSP M445	■	
		M4 × 50 DIN912	MSP M450	■	
		M5 × 16 DIN912	MSP M516	■	
		M5 × 20 DIN912	MSP M520	■	
		M5 × 25 DIN912	MSP M525	■	
		M5 × 35 DIN912	MSP M535	■	
	L-piece for MBS 090 1212 T02	8 × 8	MSP A0808 T02	■	
		10 × 10	MSP A1010 T02	■	
	Flat-head socket cap screw	M3 × 6 DIN7991	MSP M306	■	
		M3 × 8 DIN7991	MSP M308	■	
	Clamping screw for MBS 090 1212 T02	M6 × 10 DIN913	MSP 60100 IB3	■	
	Elastic washer	M4/4.3/10/0.6	MSP US-4	■	
		M5/5.3/9.2/0.45	MSP US-5	■	
	Cylindrical pin without spacer	∅6 _{h6} × 12 DIN6325	MSP ZS612	■	
	Cylindrical pin for spacer MBZ ST 02-10	∅6 _{h6} × 25 DIN6325	MSP ZS625	■	
	Cylindrical pin for spacer MBZ ST 02-20	∅6 _{h6} × 35 DIN6325	MSP ZS635	■	
	Cylindrical pin for spacer MBZ ST 02-30	∅6 _{h6} × 45 DIN6325	MSP ZS645	■	

multidec®-MODULINE is a modular tooling system with an ideal range of options designed to meet the requirements of different machines available on the market.

Grooves along the length of its base ensure excellent rigidity and precise positioning. Longitudinal positioning is ensured by a fixed (...f) or adjustable (...a) peg held in place under pressure by a sprung bearing.

A specific MODULINE tool holder plate can replace the original plate. This way, gains in reliability and tool changeover speed are very high.

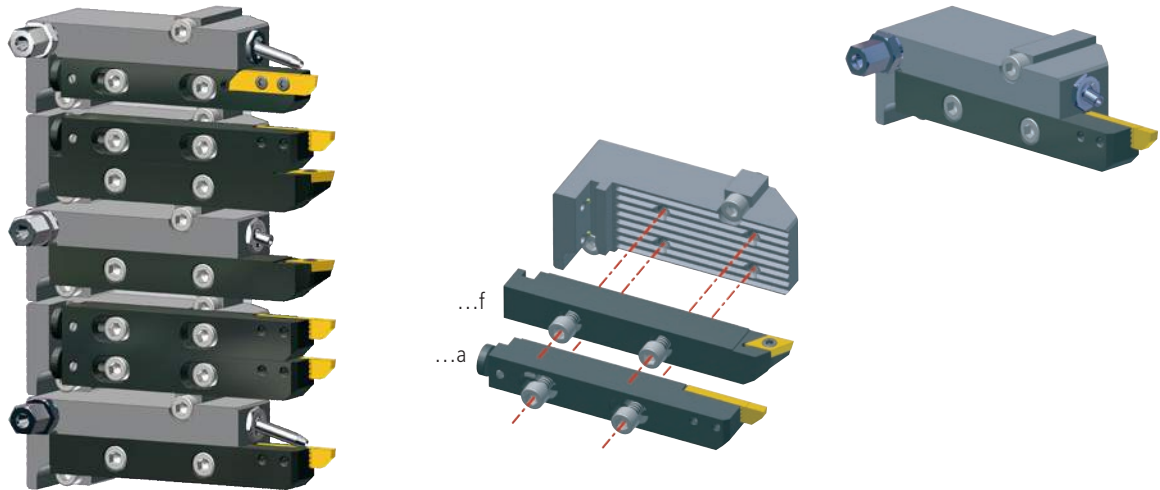

Special features and advantages:

- More tool holders per available space bring a significant productivity gain
- Easy and quick tool replacement, with presetting on fixed or adjustable length
- Stable and reliable tool location system with longitudinal serrations and large square shanks
- Versatile tooling system, easy to use, possible combination with standard tools and coolant supply devices
- Wide range of holders for multidec®-ISO, -TOP and -CUT inserts
- Applitec-compatible

Overview – multidec®-MODULINE

Technical information

11

Tool holder plate



518

Holders

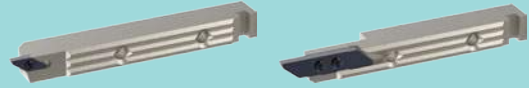

520

Replacement and spare parts



527



UML...

Machine		Order designation	
Manufacturer	Type		
Citizen	C12/C16	UML12-CITIZEN-C16	■
	L12	UML12-CITIZEN-L12	■
	R04	UML12-CITIZEN-R04-QTF3101-3T	■
		UML12-CITIZEN-R04-QTF5008-4T	■
		UML12-CITIZEN-R04-QTF5108-4T	■
	R07	UML12-CITIZEN-R07-QTF4008-5T	■
		UML12-CITIZEN-R07-QTF4108-6T	■
		UML12-CITIZEN-R07-QTF4208-3T	■
		UML12-CITIZEN-R07-QTF4608-4T	■
	K16	UML16-CITIZEN-K16	■
	L20	UML16-CITIZEN-L20	■
	L20E	UML16-CITIZEN-L20E	■
Hanwha	XD20M	UML12-HANWHA-XD20M	■
	SL12/16	UML16-HANWHA-SL12/16	■
Manuhrin	KMX 426/526/626	UML16-KMX26-DUO	■
		UML16-KMX26-JET	■
Metafil	D10	UML12-D10-3T	■
Star	SB-12RG	UML12-STAR-SB-12RG	■
	SR-10J	UML12-STAR-SR-10J	■
	SW-12RII	UML12-STAR-SW-12RII-2T	■
		UML12-STAR-SW-12RII-8T	■
	SA-12/SA-16/SA-16R	UML16-STAR-SA-16	■
	SB-16	UML16-STAR-SB-16	■
	SB-16/20RG	UML16-STAR-SB-16/20RG	■
	SB-20C/E	UML16-STAR-SB-20C/E	■
	SR-20J	UML16-STAR-SR-20J	■
	SR-16R/SR-20R/SR-20RII	UML16-STAR-SR-20R	■
	SR-20RIII	UML16-STAR-SR-20RIII	■
	SR-20RIV	UML16-STAR-SR-20RIV-2T	■
		UML16-STAR-SR-20RIV-6T	■
	SR-32J	UML16-STAR-SR-32J	■
	SV-12/20	UML16-STAR-SV-12/20	■
	SW-20R	UML16-STAR-SW-20R-2T	■
		UML16-STAR-SW-20R-6T	■

Machine		Order designation	
Manufacturer	Type		
	DECO7/10 - EvoDECO10	UML12-DECO10-DUO	■
		UML12-DECO10-JET	■
		UML12-SWISS-NANO-2T	■
SWISS-NANO	SWISS-NANO 7	UML12-SWISS-NANO-3T	■
		UML12-SWISS-NANO-6T	■
SWISS-NANO 7	UML12-SWISS-NANO-7-4T	■	
DT13	UML12-DT13-2020206-9T	■	
CT20	UML12-CT20-2020019-7T	■	
Tornos	GT13	UML12-GT13-390224-5T	■
		UML12-GT13-390223-7T	■
	DECO13 - EvoDECO16	UML16-DECO13-DUO	■
	UML16-DECO13-JET	■	
	DECO20/26 - EvoDECO20/32	UML16-DECO20-DUO	■
	UML16-DECO20-JET	■	
	ST26	UML16-SWISS-ST26-DUO	■
		UML16-SWISS-ST26-JET	■
	DT26	UML16-DT26-2020206-7T	■
	GT26	UML16-GT26-386210-5T	■
UML16-GT26-386209-6T		■	
GT32	UML16-GT32-386210-4T	■	
	UML16-GT32-386209-5T	■	
SIGMA20/32	UML16-S20-DUO	■	
	UML16-S20-JET	■	
Tsugami	B074	UML12-B074-1-6T	■
		UML12-B075-1-8T	■
	P034	UML12-PO34-1-5T	■
		UML12-PO34-1-7T	■
		UML12-PO34-2-4T	■
UML12-PO34-2-10T	■		

518
UTILIS
multidec
swiss type tools

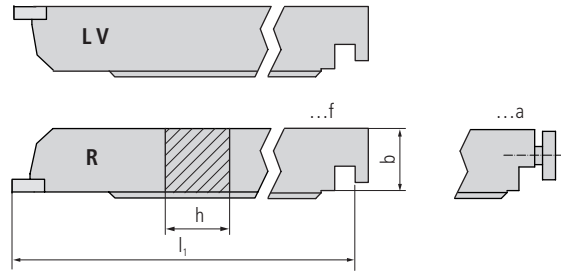

V: offset

UML... 1600...

Order designation				Dimensions						Inserts
L		R		h	b	l ₁				□49...
UML12a CUT 1600 LV	■	UML12a CUT 1600 R	■	12	15	110				16..
UML12f CUT 1600 LV	■	UML12f CUT 1600 R	■	12	15	110				16..
UML16a CUT 1600 LV	■	UML16a CUT 1600 R	■	16	16	118				16..
UML16f CUT 1600 LV	■	UML16f CUT 1600 R	■	16	16	118				16..

520

UTILIS
multidec®
swiss type tools

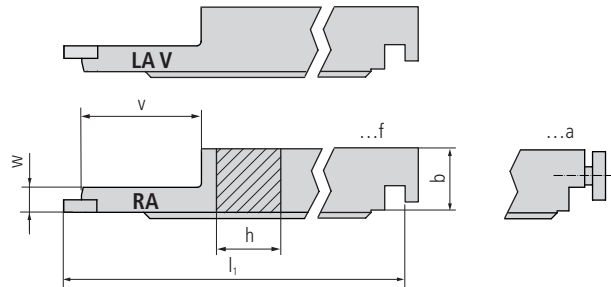

V: offset

UML... 1600... A

Order designation				Dimensions						Inserts
L		R		h	b	l ₁	v	w		□49...
UML12a CUT 1600 LA V	■	UML12a CUT 1600 RA	■	12	15	110	35	6		16..
UML12f CUT 1600 LA V	■	UML12f CUT 1600 RA	■	12	15	110	35	6		16..
UML16a CUT 1600 LA V	■	UML16a CUT 1600 RA	■	16	16	118	35	6		16..
UML16f CUT 1600 LA V	■	UML16f CUT 1600 RA	■	16	16	118	35	6		16..

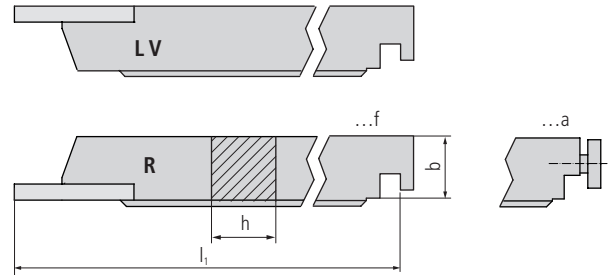

V: offset

UML... 3000...

Order designation				Dimensions						Inserts
L		R		h	b	l ₁				□ 111...
UML12a CUT 3000 LV	■	UML12a CUT 3000 R	■	12	15	110				30..
UML12f CUT 3000 LV	■	UML12f CUT 3000 R	■	12	15	110				30..
UML16a CUT 3000 LV	■	UML16a CUT 3000 R	■	16	16	118				30..
UML16f CUT 3000 LV	■	UML16f CUT 3000 R	■	16	16	118				30..

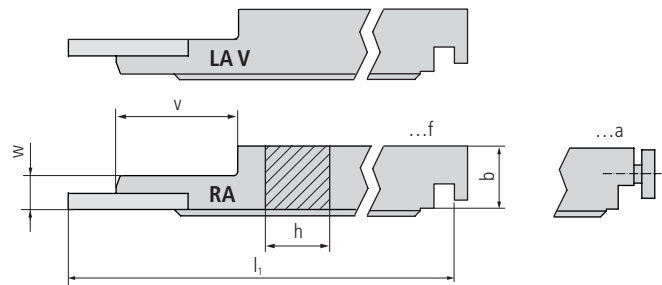

V: offset

UML... 3000... A

Order designation				Dimensions						Inserts
L		R		h	b	l ₁	v	w		□ 111...
UML12a CUT 3000 LA V	■	UML12a CUT 3000 RA	■	12	15	110	29	8		30..
UML12a CUT 3000 LAV SN*	■	UML12a CUT 3000 RA SN*	■	12	15	116	28	8		30..
UML12f CUT 3000 LA V	■	UML12f CUT 3000 RA	■	12	15	110	29	8		30..
UML16a CUT 3000 LA V	■	UML16a CUT 3000 RA	■	16	16	110	29	8		30..
UML16f CUT 3000 LA V	■	UML16f CUT 3000 RA	■	16	16	110	29	8		30..

* SN: Tornos SWISS NANO – For cut-off position T1

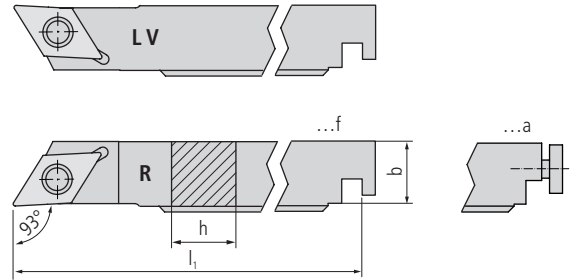

V: offset

UML... SDJC... (93°)

Order designation				Dimensions							Inserts
L		R		h	b	l ₁					□ 201...
		UML12a SDJCR 07	■	12	15	110					DC..0702..
		UML12f SDJCR 07	■	12	15	110					DC..0702..
UML12a SDJCL 11 V	■	UML12a SDJCR 11	■	12	15	110					DC..11T3..
		UML12f SDJCR 11	■	12	15	110					DC..11T3..
		UML16a SDJCR 07	■	16	16	118					DC..0702..
		UML16f SDJCR 07	■	16	16	118					DC..0702..
UML16a SDJCL 11 V	■	UML16a SDJCR 11	■	16	16	118					DC..11T3..
		UML16f SDJCR 11	■	16	16	118					DC..11T3..

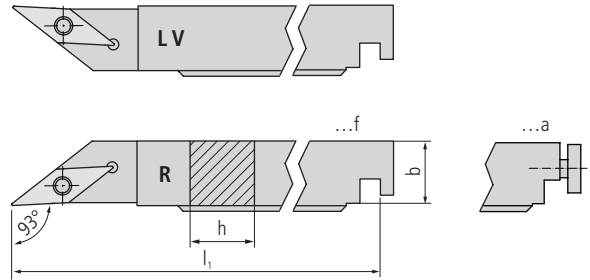
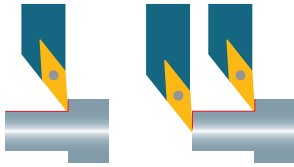

V: offset

UML... SVJC... (93°)

Order designation				Dimensions							Inserts
L		R		h	b	l ₁					□ 259...
UML12a SVJCL 11 V	■	UML12a SVJCR 11	■	12	15	110					VC..1103..
		UML12f SVJCR 11	■	12	15	110					VC..1103..
UML16a SVJCL 11 V	■	UML16a SVJCR 11	■	16	16	118					VC..1103..
		UML16f SVJCR 11	■	16	16	118					VC..1103..

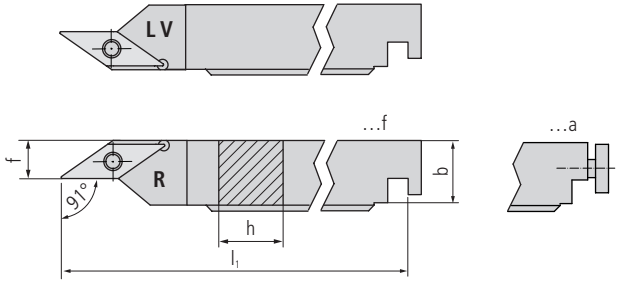

V: offset

UML... SVXC... (91°)

Order designation				Dimensions							Inserts
L		R		h	b	l ₁		f			□ 259...
UML12a SVXCL 11 V	■	UML12a SVXCR 11	■	12	15	110		5.4			VC..1103..
UML12f SVXCL 11 V	■	UML12f SVXCR 11	■	12	15	110		5.4			VC..1103..
UML16a SVXCL 11 V	■	UML16a SVXCR 11	■	16	16	118		8.9			VC..1103..
UML16f SVXCL 11 V	■	UML16f SVXCR 11	■	16	16	118		8.9			VC..1103..

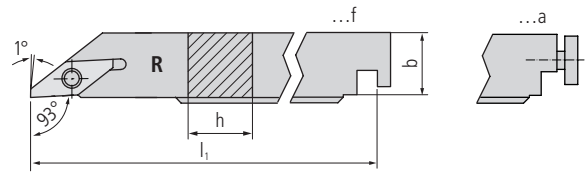

UML... SVJP... (93°)

V: offset

Order designation				Dimensions							Inserts	
L		R		h	b	l ₁						□ 305...
UML12a SVJPL 10 V	■	UML12a SVJPR 10	■	12	15	110						VP..1003..
UML12f SVJPL 10 V	■	UML12f SVJPR 10	■	12	15	110						VP..1003..
UML16a SVJPL 10 V	■	UML16a SVJPR 10	■	16	16	118						VP..1003..
UML16f SVJPL 10 V	■	UML16f SVJPR 10	■	16	16	118						VP..1003..

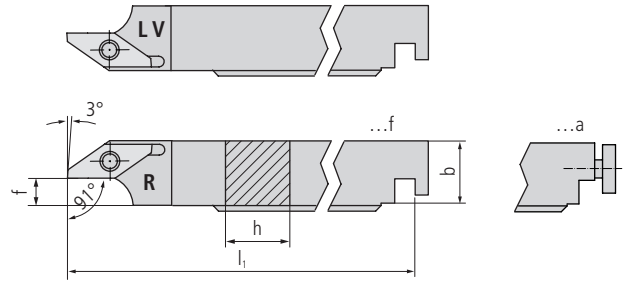

V: offset

UML... SVXP... (91°)

Order designation				Dimensions							Inserts
L		R		h	b	l ₁		f			□ 305...
UML12a SVXPL 10 V	■	UML12a SVXPR 10	■	12	15	110		5			VP..1003..
UML12f SVXPL 10 V	■	UML12f SVXPR 10	■	12	15	110		5			VP..1003..
UML16a SVXPL 10 V	■	UML16a SVXPR 10	■	16	16	118		9			VP..1003..
UML16f SVXPL 10 V	■	UML16f SVXPR 10	■	16	16	118		9			VP..1003..

Illustration	Description	Dimensions	Order designation	Holder
	TORX screw	M2.5 × 6 T08	MSP 25060 T08	■ UML... 1600... UML... SV.P... 10 UML... SV...11
		M3 × 7.3 T08	MSP 30073 T08	■ UML... 3000...A
		M3 × 9 T08	MSP 30090 T08	■ UML... 3000...
		M3.5 × 11 T15	MSP 35110 T15	■ UML... SD...11

TORX screwdriver  651...

multidec®-KM™ is a precise and robust quick-change system for automatic lathes with an interface to ISO standard 26622.
 UTILIS has suitable holders for multidec®-CUT, -TOP and for multidec®-BORE MICRO inserts for the KM Micro™ system.

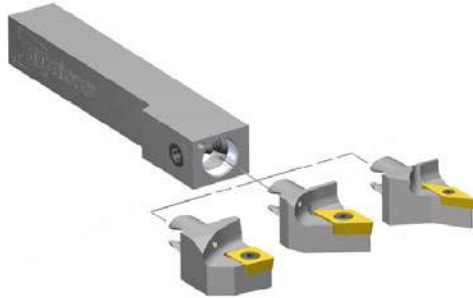

KM™ is a Trademark of Kennametal Inc.

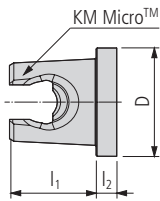

Advantages:

- Fast and simple installation of KM™ basic tool holders into the existing tool positions
- Quick tool changes
- Annealed holders
- High-quality multidec® cutting edges



Size	System		Dimensions		
	Kennametal Widia	Ceratizit	D	l ₁	l ₂
12	KM Micro™	KM12	12	13	–
16		KM16	16	14.3	–

Overview – multidec®-KM™

Technical information		11
Holders (OD turning)		530
Holders (ID turning)		534
Replacement and spare parts		535

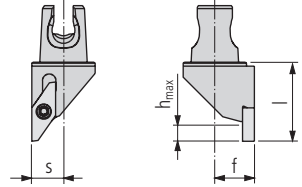
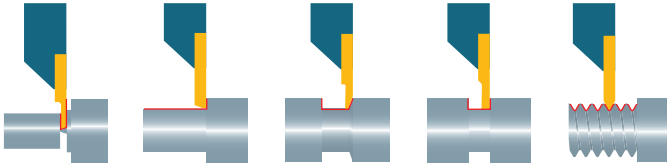

KM 12/16/20 CUT 1600 .

Order designation				Dimensions								Inserts	
L		R		KM	f	l				s	h _{max}		49...
■	■	■	■	12	8	20				6	5		16...
■	■	■	■	16	10	20				8	5		16...

530

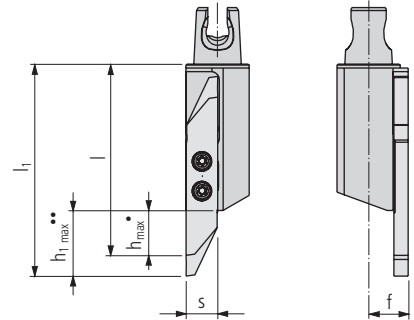

KM 12/16 CUT 3000 ...

Order designation				Dimensions								Inserts	
L		R		KM	f	l	l ₁			s	h _{max}	h _{1 max}	111...
■	■	■	■	12	8	43	—			6	10	—	30...
■	■	■	■	16	10	48	54			8	10	16	30...

• Short insert; •• Long insert

UTILIS **multidec**® swiss type tools

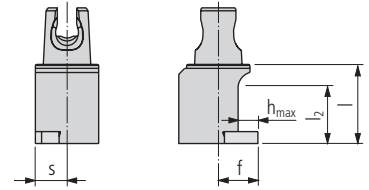
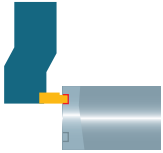

KM 12/16 CUT 1600-90 ...

Order designation				Dimensions								Inserts	
L		R		KM	f	l	l ₂			s	h _{max}		□ 49...
KM 12 CUT 1600-90 L	■	KM 12 CUT 1600-90 R	■	12	8	20	14			6	5		16...
KM 16 CUT 1600-90 L	■	KM 16 CUT 1600-90 R	■	16	10	20	14			8	5		16...

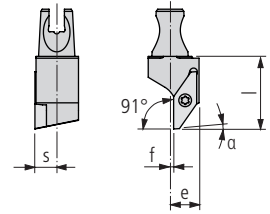

KM 12/16/20 SVXP... (91°)

Order designation				Dimensions								Inserts*
L		R		KM	f	l	e			s	a	□305...
KM 12 SVXPL 10	■	KM 12 SVXPR 10	■	12	1	20	8			6	3°	VP..1003..
KM 16 SVXPL 10	■	KM 16 SVXPR 10	■	16	3	20	10			8	3°	VP..1003..
KM 20 SVXPL 10	■	KM 20 SVXPR 10	■	20	5.5	25	10.5			9.5	3°	VP..1003..

* Attention
 Right hand holder needs left hand insert!

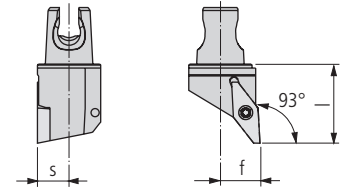
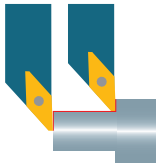

KM 12/16 SVJP... (93°)

Order designation				Dimensions								Inserts	
L		R		KM	f	l				s			□ 305...
KM 12 SVJPL 10	■	KM 12 SVJPR 10	■	12	8	20				6			VP..1003..
KM 16 SVJPL 10	■	KM 16 SVJPR 10	■	16	10	20				8			VP..1003..

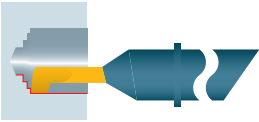

KM 12 SDA...



KM 16 SDA...

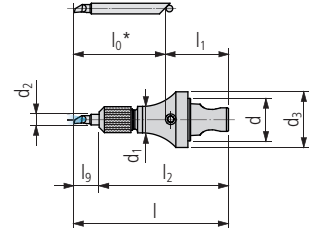
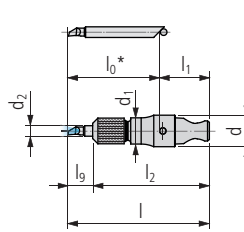

Order designation				Dimensions										Inserts		
				KM	d	l	lg	l1	l2	d1	d2	d3				□ 335...
N																
KM 12 SDA-4	■			12	12	l ₀ +1	l-2	6	31.5	10	4	-				SD.4... / SX.4...
KM 12 SDA-6	■			12	12	l ₀ +1	l-2	6	35.5	15	6	15				SD.6... / SX.6...
KM 12 SDA-8	■			12	12	l ₀ +1	l-2	6	37.5	18	8	18				SD.8... / SX.8...
KM 16 SDA-4 IC	■			16	16	l ₀ +1	l-2	9	34.5	10	4	21				SD.4... / SX.4...
KM 16 SDA-6 IC	■			16	16	l ₀ +1	l-2	9	38.5	15	6	21				SD.6... / SX.6...
KM 16 SDA-8 IC	■			16	16	l ₀ +1	l-2	9	40.5	18	8	21				SD.8... / SX.8...

* The length of the insert is variable

Illustration	Description	Dimensions	Order designation	Holder	Inserts
	TORX screw	M2.5 × 8 T08	MSP 25060 T08	■	KM.. CUT 1600, KM.. SV.P.10
		M3 × 9 T08	MSP 30090 T08	■	KM.. CUT 3000.
	Nut	M8 × 0.5	MSP SDA 4M	■	KM..SDA-4.
		M12 × 0.6	MSP SDA 6M	■	KM..SDA-6.
		M14 × 0.75	MSP SDA 8M	■	KM..SDA-8.
	Aligning device		SDA 4X	■	KM..SDA-4.
			SDA 6X	■	KM..SDA-6.
			SDA 8X	■	KM..SDA-8.
	Retaining ring		MSP SDA 4S	■	SD. 4... SX. 4...
			MSP SDA 6S	■	SD. 6... SX. 6...
			MSP SDA 8S	■	SD. 8... SX. 8...

TORX screwdriver 651...





Use of the multidec®-HSK-system with ISO 12164/DIN 69893 standardized attachment has become increasingly widespread in recent years. This system makes the customer independent from specific tool system, which is a great advantage. Simplicity, precision and reliability: these are the criteria that customers place on modern tool systems. HSK tools largely satisfy these demands and help to maximize productivity. The program comprises a wide selection of tool holders for both OD and ID turning on lathes. The standard range has been developed in size 32 and form "C" for manual tool changing. Now we propose a new size 40 in form HSK-T for the automatic- and manual tool change. Other HSK shapes and sizes are available on request.

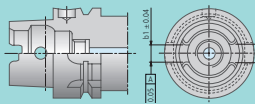

Advantages:

- Large program of toolholders in heat-treatable steel, with internal cooling, available from stock
- Holder with high rigidity and repeat accuracy
- High precision in positioning of cutting edge, cause of the axial positioning and the close tolerance of the holder keyway HSK-T standard ISO 12164
- Utilisation of high quality UTILIS multidec®-inserts

Overview – multidec®-HSK

Technical information		11
HSK-versions		538
Holders (IOD turning)		540
Holders (ID turning)		544
Closing plug		546
Replacement and spare parts		547

HSK – Form A

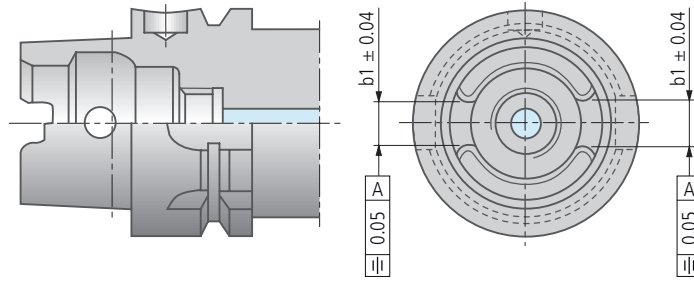

- Used on machining centers, milling machines, turning machines, special machines with automatic tool change
- Central, axial coolant supply through coolant tube
- Torque transmission via two key slots at end of taper
- Two slots on collar for tool magazine, location edge hole for data carrier in collar

HSK – Form C

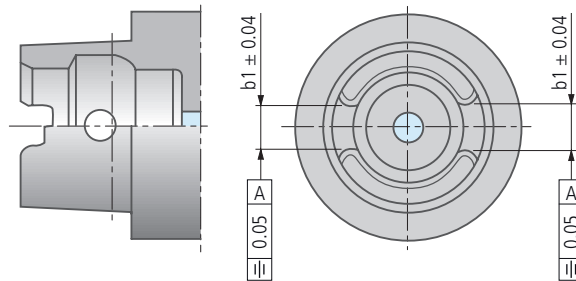

- Preferably used for spindles on transfer lines and special machines without automatic tool change or for short bore spindles and tool extensions and reductions
- Central, axial coolant supply
- Torque transmission via two key slots at end of taper

HSK – Form T

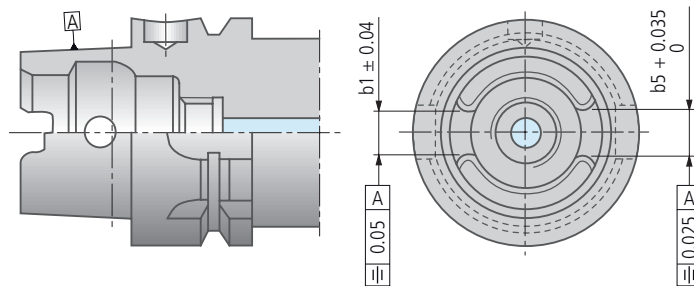

Tighter tolerance for perfect change precision

The "T" stands for "Turning". HSK-T combines the basic shape of the HSK taper in form A/C and differs by closer tolerances of the cam grooves on the cone of the tools. This important feature for turning assures accurate radial positioning (center height).

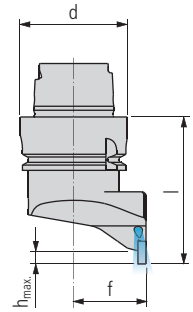

HSK... CUT 1600 .

Order designation				Form / Size	Dimensions					Inserts
L		R		HSK	d	f	l		h _{max}	□49...
HSK-C32 CUT 1600 L	■	HSK-C32 CUT 1600 R	■	C32	32	22	40		5	16...
HSK-T40 CUT 1600 L	■	HSK-T40 CUT 1600 R	■	A40 / C40	40	27	55		5	16...

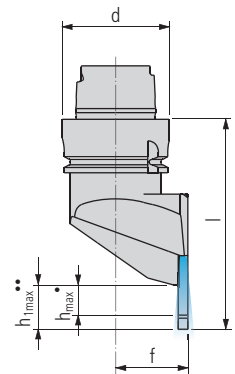

HSK... CUT 3000 .

Order designation				Form / Size	Dimensions					Inserts	
L		R		HSK	d	f	l		h _{max}	h _{1max}	□111...
HSK-C32 CUT 3000 L	■	HSK-C32 CUT 3000 R	■	C32	32	22	50		10	16	30...
HSK-T40 CUT 3000 L	■	HSK-T40 CUT 3000 R	■	A40 / C40	40	27	73		10	16	30...

● Short insert; ●● Long insert

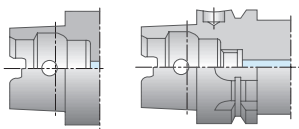

HSK-C... HSK-T (A/C)... Versions □ 538

540
 UTILIS
 multidec®
 swiss type tools

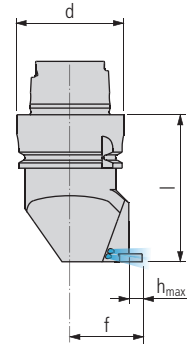
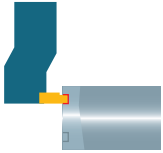

HSK... CUT 1600-90 .

Order designation				Form / Size	Dimensions						Inserts*	
L		R		HSK	d	f	l			h _{max}		⌀49...
HSK-C32 CUT 1600-90 L	■	HSK-C32 CUT 1600-90 R	■	C32	32	22	40			5		16...
HSK-T40 CUT 1600-90 L	■	HSK-T40 CUT 1600-90 R	■	A40 / C40	40	27	55			5		16...

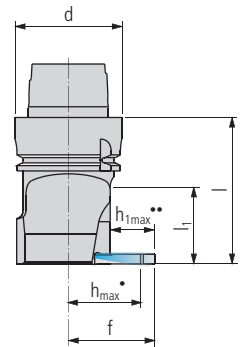

HSK... CUT 3000-90 .

Order designation				Form / Size	Dimensions						Inserts*	
L		R		HSK	d	f	l	l ₁		h _{max}	h _{1max}	⌀111...
HSK-C32 CUT 3000-90 L	■	HSK-C32 CUT 3000-90 R	■	C32	32	22	40	24		10	—	30...
HSK-T40 CUT 3000-90 L	■	HSK-T40 CUT 3000-90 R	■	A40 / C40	40	27	55	30		10	16	30...

• Short insert; •• Long insert

* Attention
 Right hand holder needs left hand insert!

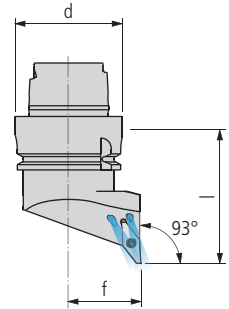
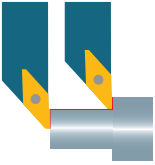

HSK... SVJP... (93°)

Order designation				Form / Size	Dimensions							Inserts	
L		R		HSK	d	f	l						□ 305...
HSK-C32 SVJPL 10	■	HSK-C32 SVJPR 10	■	C32	32	22	40						VP...1003...
HSK-T40 SVJPL 10	■	HSK-T40 SVJPR 10	■	A40 / C40	40	27	55						VP...1003...

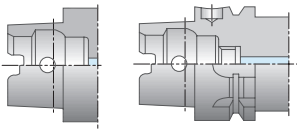

HSK-C... HSK-T (A/C)... Versions □ 538

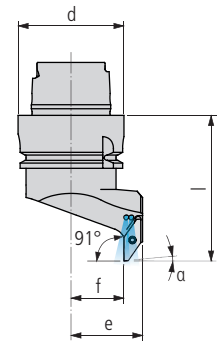

HSK... SVXP... (91°)

Order designation				Form / Size	Dimensions						Inserts*
L		R		HSK	d	f	l	e		a	□ 305...
HSK-C32 SVXPL 10	■	HSK-C32 SVXPR 10	■	C32	32	15	40	22		3°	VP...1003...
HSK-T40 SVXPL 10	■	HSK-T40 SVXPR 10	■	A40 / C40	40	20	55	27		3°	VP...1003...

*** Attention**
Right hand holder needs left hand insert!

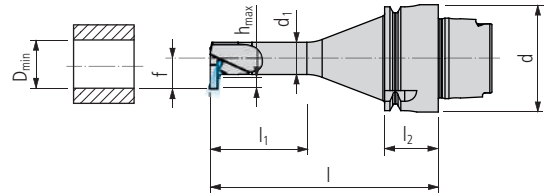

HSK... CUT 1600... RD

Order designation				Form / Size	Dimensions								Inserts*
L		R		HSK	d	f	l	D _{min}	l ₁	l ₂	d ₁	h _{max}	□49...
HSK-C32 CUT 1600-12 RD L	■	HSK-C32 CUT 1600-12 RD R	■	C32	32	11	75	17.5	36	10	12	3	16...
HSK-C32 CUT 1600-16 RD L	■	HSK-C32 CUT 1600-16 RD R	■	C32	32	13	75	21	48	10	16	4	16...
HSK-C32 CUT 1600-20 RD L	■	HSK-C32 CUT 1600-20 RD R	■	C32	32	15	75	25	60	10	20	4	16...
HSK-T40 CUT 1600-12 RD L	■	HSK-T40 CUT 1600-12 RD R	■	A40 / C40	40	11	85	17.5	36	20	12	3	16...
HSK-T40 CUT 1600-16 RD L	■	HSK-T40 CUT 1600-16 RD R	■	A40 / C40	40	13	85	21	48	20	16	4	16...
HSK-T40 CUT 1600-20 RD L	■	HSK-T40 CUT 1600-20 RD R	■	A40 / C40	40	15	85	25	60	20	20	4	16...

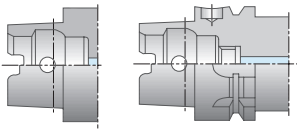

HSK-C... HSK-T (A/C)... Versions □ 538

* Attention
 Right hand holder needs left hand insert!

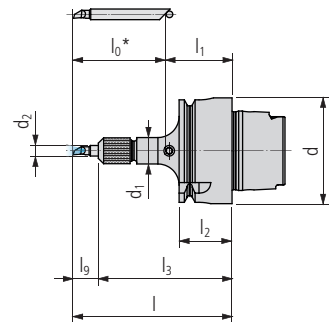
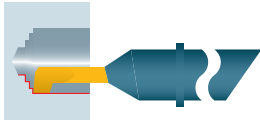

HSK... SDA...

Order designation	Form / Size	Dimensions								Inserts
		HSK	d	l	l ₀	l ₁	l ₂	l ₃	d ₁	d ₂
N HSK-C32 SDA-4	■ C32	32	l ₀ +l ₁	l- ₃	15	10	40.5	10	4	SD.4.../SX.4...
HSK-C32 SDA-6	■ C32	32	l ₀ +l ₁	l- ₃	15	10	44.5	15	6	SD.6.../SX.6...
HSK-C32 SDA-8	■ C32	32	l ₀ +l ₁	l- ₃	15	10	46.5	18	8	SD.8.../SX.8...
HSK-T40 SDA-4	■ A40 / C40	40	l ₀ +l ₁	l- ₃	25	20	50.5	10	4	SD.4.../SX.4...
HSK-T40 SDA-6	■ A40 / C40	40	l ₀ +l ₁	l- ₃	25	20	54.5	15	6	SD.6.../SX.6...
HSK-T40 SDA-8	■ A40 / C40	40	l ₀ +l ₁	l- ₃	25	20	56.5	18	8	SD.8.../SX.8...

* The length of the insert is variable

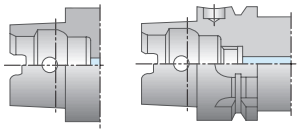

HSK-C... HSK-T (A/C)... Versions □ 538

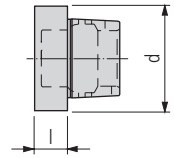





HSK... VS

Order designation	Form / Size	Dimensions							
		HSK	d	l					
HSK-C32 VS	■ C32		32	10					
HSK-C40 VS	■ C40		40	15					

For holders (CUT/SC/SD/SV...) OD turning

Illustration	Description	Dimensions	Order designation	Holder
	TORX screw	M2.5 × 6 T08	MSP 25060 T08	■ HSK ... CUT 1600 ... HSK ... SV.P ...
		M3 × 9 T08	MSP 30090 T08	■ HSK ... CUT 3000 ...

For holders (CUT/SC/SD/SV...) ID turning

Illustration	Description	Dimensions	Order designation	Holder	Inserts
	TORX screw	M2.5 × 6 T08	MSP 25060 T08	■	HSK ... CUT 1600 ... RD
	Nut	M8 × 0.5	MSP SDA 4M	■	HSK..SDA-4.
		M12 × 0.6	MSP SDA 6M	■	HSK..SDA-6.
		M14 × 0.75	MSP SDA 8M	■	HSK..SDA-8.
	Aligning device		SDA 4X	■	HSK..SDA-4.
			SDA 6X	■	HSK..SDA-6.
			SDA 8X	■	HSK..SDA-8.
	Retaining ring		MSP SDA 4S	■	SD. 4... SX. 4...
			MSP SDA 6S	■	SD. 6... SX. 6...
			MSP SDA 8S	■	SD. 8... SX. 8...

TORX screwdriver 651...

multidec®-PSC is a flexible and modular quick change toolholder-system, with a polygon-connection compliant with ISO 26623-1 standard. High torque transmission is one basic advantage of the system. The program includes tool holders suitable for turning machines with multidec®-CUT, multidec®-TOP and multidec®-BORE MICRO inserts.



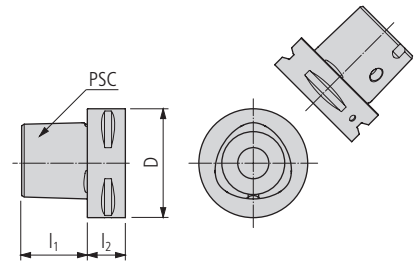

Advantages:

- Connection with high rigidity, repeat accuracy and self-centering
- Quick change of toolholders
- Toolholders with heat-treatable steel and internal cooling
- Utilisation of high quality multidec® inserts



Size		Dimensions		
PSC	Sandvik Coromant Capto®	D	l ₁	l ₂
32	C3	32	19	15
40	C4	40	24	20
50	C5	50	30	20
63	C6	63	38	22
80	C8	80	48	30
100	C10	100	60	32

Overview – multidec®-PSC

Technical information		11
HOLDERS (OD turning)		550
HOLDERS (ID turning)		554
Replacement and spare parts		556

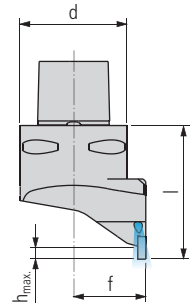
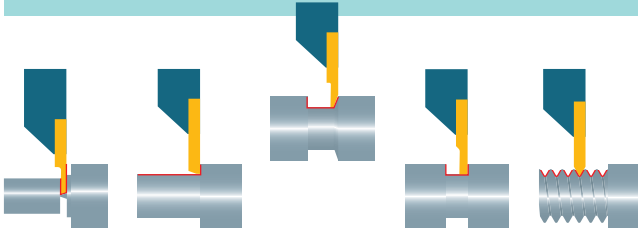

PSC ... CUT 1600 .

Order designation				Size	Dimensions						Inserts
L		R		PSC	d	f	l			h _{max}	□49...
PSC 32 CUT 1600 L	■	PSC 32 CUT 1600 R	■	32	32	22	40			5	16...
PSC 40 CUT 1600 L	■	PSC 40 CUT 1600 R	■	40	40	27	50			5	16...

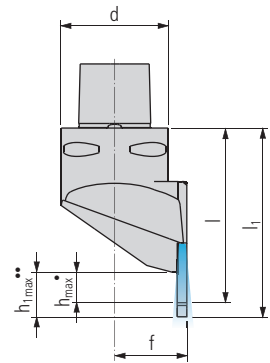

PSC ... CUT 3000 .

Order designation				Size	Dimensions						Inserts	
L		R		PSC	d	f	l	l ₁		h _{max}	h _{1max}	□111...
PSC 32 CUT 3000 L	■	PSC 32 CUT 3000 R	■	32	32	22	60	66		10	16	30...
PSC 40 CUT 3000 L	■	PSC 40 CUT 3000 R	■	40	40	27	65	71		10	16	30...

● Short insert; ●● Long insert

550

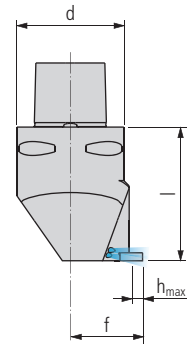
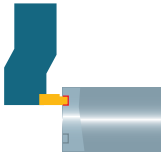

PSC ... CUT 1600-90 .

Order designation				Size	Dimensions							Inserts*	
L		R		PSC	d	f	l				h_{max}		□49...
PSC 32 CUT 1600-90 L	■	PSC 32 CUT 1600-90 R	■	32	32	22	40				5		16...
PSC 40 CUT 1600-90 L	■	PSC 40 CUT 1600-90 R	■	40	40	27	50				5		16...

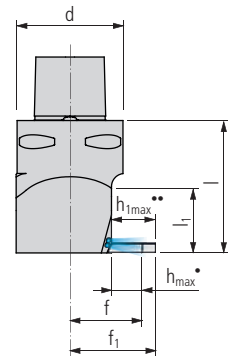

PSC ... CUT 3000-90 .

Order designation				Size	Dimensions							Inserts*	
L		R		PSC	d	f	f_1	l	l_1		h_{max}	h_{1max}	□111...
PSC 32 CUT 3000-90 L	■	PSC 32 CUT 3000-90 R	■	32	32	22	27	40	19		10	16	30...
PSC 40 CUT 3000-90 L	■	PSC 40 CUT 3000-90 R	■	40	40	27	32	50	30		10	16	30...

• Short insert; •• Long insert

* Attention
 Right hand holder needs left hand insert!

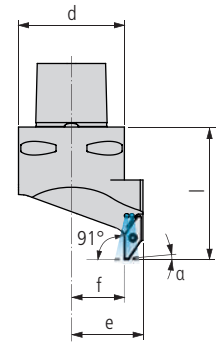

PSC ... SVXP... (91°)

Order designation				Size	Dimensions							Inserts*
L		R		PSC	d	f	l	e			a	□305...
PSC 32 SVXPL 10	■	PSC 32 SVXPR 10	■	32	32	15	40	22			3°	VP...1003...
PSC 40 SVXPL 10	■	PSC 40 SVXPR 10	■	40	40	20	50	27			3°	VP...1003...

*** Attention**
Right hand holder needs left hand insert!

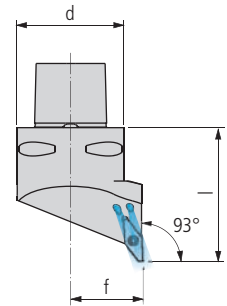
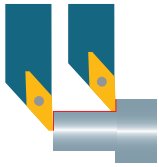

PSC ... SVJP... (93°)

Order designation				Size	Dimensions								Inserts	
L		R		PSC	d	f	l							305...
PSC 32 SVJPL 10	■	PSC 32 SVJPR 10	■	32	32	22	40							VP...1003...
PSC 40 SVJPL 10	■	PSC 40 SVJPR 10	■	40	40	27	50							VP...1003...

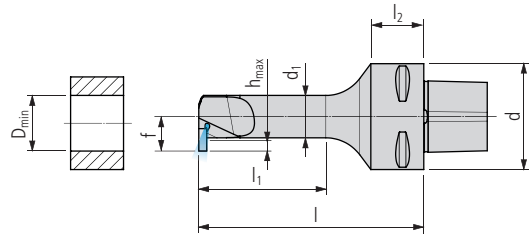

PSC ... CUT 1600... RD

Order designation				Size	Dimensions								Inserts*
L		R		PSC	d	f	l	D _{min}	l ₁	l ₂	d ₁	h _{max}	□49...
PSC 32 CUT 1600-12 RD L	■	PSC 32 CUT 1600-12 RD R	■	32	32	11	80	17.5	36	15	12	3	16...
PSC 32 CUT 1600-16 RD L	■	PSC 32 CUT 1600-16 RD R	■	32	32	13	80	21	48	15	16	4	16...
PSC 32 CUT 1600-20 RD L	■	PSC 32 CUT 1600-20 RD R	■	32	32	15	80	25	60	15	20	4	16...
PSC 40 CUT 1600-12 RD L	■	PSC 40 CUT 1600-12 RD R	■	40	40	11	85	17.5	36	20	12	3	16...
PSC 40 CUT 1600-16 RD L	■	PSC 40 CUT 1600-16 RD R	■	40	40	13	85	21	48	20	16	4	16...
PSC 40 CUT 1600-20 RD L	■	PSC 40 CUT 1600-20 RD R	■	40	40	15	85	25	60	20	20	4	16...

* Attention
 Right hand holder needs left hand insert!

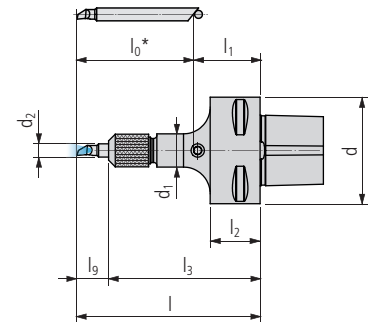
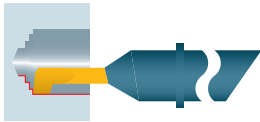





PSC ... SDA...

Order designation	Size	Dimensions									Inserts □ 335...
		PSC	d	l	l _g	l ₁	l ₂	l ₃	d ₁	d ₂	
N PSC 32 SDA-4	■ 32		32	l ₀ +l ₁	l- ₃	20	15	45.5	10	4	SD.4.../SX.4...
PSC 32 SDA-6	■ 32		32	l ₀ +l ₁	l- ₃	20	15	49.5	15	6	SD.6.../SX.6...
PSC 32 SDA-8	■ 32		32	l ₀ +l ₁	l- ₃	20	15	51.5	18	8	SD.8.../SX.8...
PSC 40 SDA-4	■ 40		40	l ₀ +l ₁	l- ₃	25	20	50.5	10	4	SD.4.../SX.4...
PSC 40 SDA-6	■ 40		40	l ₀ +l ₁	l- ₃	25	20	54.5	15	6	SD.6.../SX.6...
PSC 40 SDA-8	■ 40		40	l ₀ +l ₁	l- ₃	25	20	56.5	18	8	SD.8.../SX.8...

For holders (CUT/TOP...) OD turning

Illustration	Description	Dimensions	Order designation	Holder
	TORX screw	M2.5×6 T08	MSP 25060 T08	■ PSC ... CUT 1600 ... PSC ... SV.P ...
		M3×9 T08	MSP 30090 T08	■ PSC ... CUT 3000 ...

For holders (CUT...) ID turning

Illustration	Description	Dimensions	Order designation	Holder	Inserts
	TORX screw	M2.5×6 T08	MSP 25060 T08	■	PSC ... CUT 1600 ... RD
	Nut	M8×0.5	MSP SDA 4M	■	PSC..SDA-4.
		M12×0.6	MSP SDA 6M	■	PSC..SDA-6.
		M14×0.75	MSP SDA 8M	■	PSC..SDA-8.
	Aligning device		SDA 4X	■	PSC..SDA-4.
			SDA 6X	■	PSC..SDA-6.
			SDA 8X	■	PSC..SDA-8.
	Retaining ring		MSP SDA 4S	■	SD. 4... SX. 4...
			MSP SDA 6S	■	SD. 6... SX. 6...
			MSP SDA 8S	■	SD. 8... SX. 8...

TORX screwdriver □ 651...

Solid and compact tools are an enormous advantage for turning operations on multitask machines. Specially-designed tools must be used with the machine spindle during the turning process that can allow work to be done very close to the main or opposed spindle. Any errors in the height of the cutting edge and torsional forces should also be kept to a minimum.

With the HSK-E40, HSK-T32, HSK-T40, HSK-A40 and PSC 40 (Capto C4) spindles, this sophisticated range of tools offers ideal solutions for modern turning and milling centers.

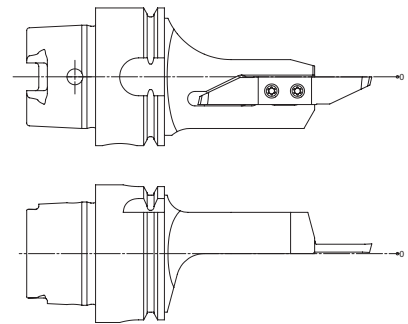

Advantages:

- Monoblock tools with interchangeable inserts
- Compact and solid design
- The insert is positioned on the center line (guaranteeing a very accurate cutting edge height and high repeatability while also reducing of the load on the spindle)
- All tools are equipped with integrated coolant supply
- The high quality UTILIS inserts from the multidec®-CUT, -ISO, -TOP and -BORE MICRO series can be used

Technical information		11
Holders HSK-T32/T40/A40 ... (OD turning)		560
Holders HSK-T32/T40/A40 ... (ID turning)		566
Holders PSC 40 ... (OD turning)		567
Holders PSC 40 ... (ID turning)		573
Holders HSK-E40 ... WM (OD turning for Willemin-Macodel machines)		574
Holders HSK-E40 ... WM (ID turning for Willemin-Macodel machines)		580
Replacement and spare parts		581

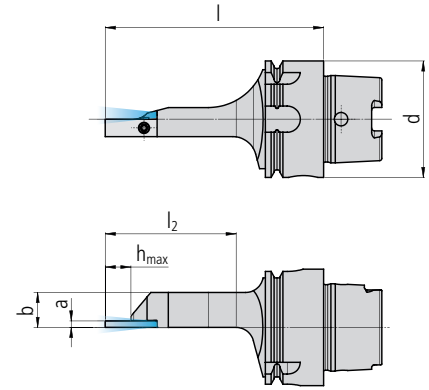

HSK-... MT CUT 500 .

Order designation				Form / Size	Dimensions							Inserts	
L		R		HSK	d	b	l	l ₂	a			h _{max}	□45...
HSK-T32 MT CUT 500 L	■	HSK-T32 MT CUT 500 R	■	T32	32	12	65	35	2			8.5	50.
HSK-T40 MT CUT 500 L	■	HSK-T40 MT CUT 500 R	■	T40	40	12	75	45	2			8.5	50.
HSK-A40 MT CUT 500 L	■	HSK-A40 MT CUT 500 R	■	A40	40	12	75	45	2			8.5	50.

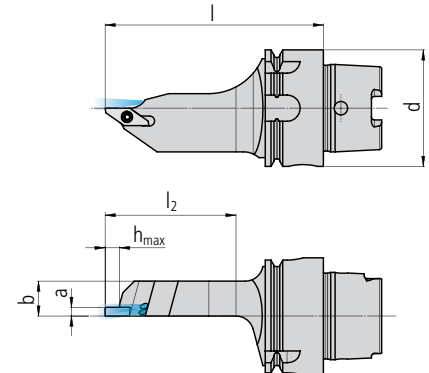

HSK-... MT CUT 1600 .

Order designation				Form / Size	Dimensions							Inserts	
L		R		HSK	d	b	l	l ₂	a			h _{max}	□49...
HSK-T32 MT CUT 1600 L	■	HSK-T32 MT CUT 1600 R	■	T32	32	12	65	35	3			5	16..
HSK-T40 MT CUT 1600 L	■	HSK-T40 MT CUT 1600 R	■	T40	40	12	75	45	3			5	16..
HSK-A40 MT CUT 1600 L	■	HSK-A40 MT CUT 1600 R	■	A40	40	12	75	45	3			5	16..

560

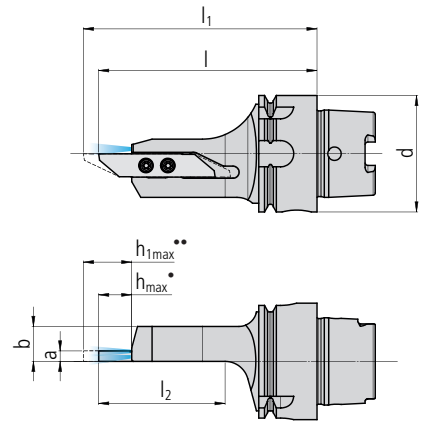

HSK-... MT CUT 3000 .

Order designation				Form / Size	Dimensions								Inserts
L				HSK	d	b	l	l ₁	l ₂	a	h _{max}	h _{1max}	□ 111...
					HSK-T32 MT CUT 3000 L	■	HSK-T32 MT CUT 3000 R	■	T32	32	12	65	—
HSK-T40 MT CUT 3000 L	■	HSK-T40 MT CUT 3000 R	■	T40	40	12	75	80	45	3.5	10	16	30..
HSK-A40 MT CUT 3000 L	■	HSK-A40 MT CUT 3000 R	■	A40	40	12	75	80	45	3.5	10	16	30..

• Short insert; •• Long insert

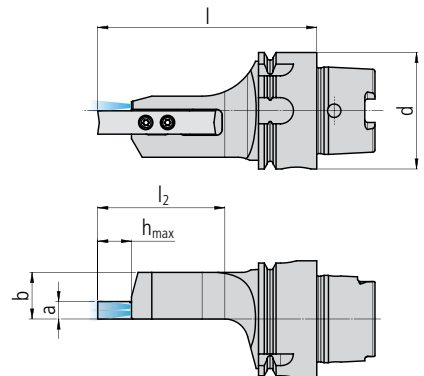

HSK-... MT CUT 3600 .

Order designation				Form / Size	Dimensions								Inserts
L				HSK	d	b	l	l ₂	a		h _{max}	□ 161...	
					HSK-T40 MT CUT 3600 L	■	HSK-T40 MT CUT 3600 R	■	T40	40	16	75	43
HSK-A40 MT CUT 3600 L	■	HSK-A40 MT CUT 3600 R	■	A40	40	16	75	43	6		10	36..	

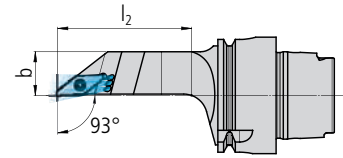
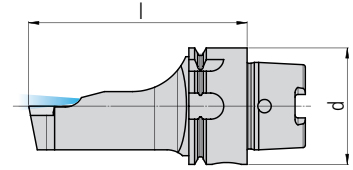
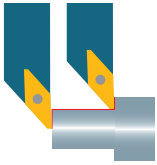

HSK-... MT SVJP... (93°)

Order designation				Form / Size	Dimensions				Inserts
L		R		HSK	d	b	l	l ₂	□305...
HSK-T32 MT SVJPL 10	■	HSK-T32 MT SVJPR 10	■	T32	32	12	65	36	VP.. 1003..
HSK-T40 MT SVJPL 10	■	HSK-T40 MT SVJPR 10	■	T40	40	15	75	46	VP.. 1003..
HSK-A40 MT SVJPL 10	■	HSK-A40 MT SVJPR 10	■	A40	40	15	75	46	VP.. 1003..

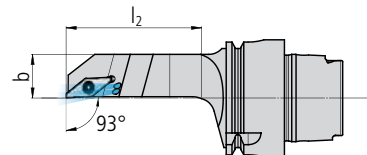
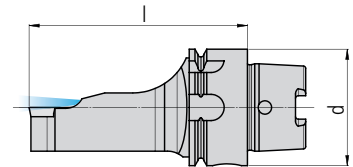

HSK-... MT SVJP... V (93°)

Order designation				Form / Size	Dimensions				Inserts
L		R		HSK	d	b	l	l ₂	□305...
HSK-T32 MT SVJPL 10 V	■	HSK-T32 MT SVJPR 10 V	■	T32	32	12	65	36	VP.. 1003..
HSK-T40 MT SVJPL 10 V	■	HSK-T40 MT SVJPR 10 V	■	T40	40	15	75	46	VP.. 1003..
HSK-A40 MT SVJPL 10 V	■	HSK-A40 MT SVJPR 10 V	■	A40	40	15	75	46	VP.. 1003..

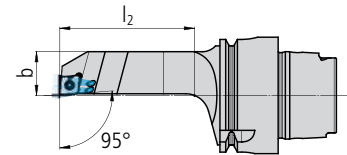
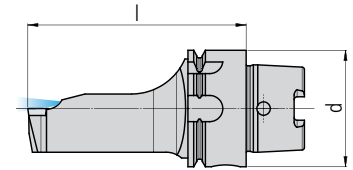
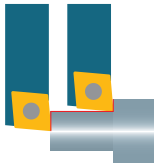

HSK-... MT SCLC... (95°)

Order designation				Form / Size	Dimensions						Inserts	
L		R		HSK	d	b	l	l ₂				□ 177...
HSK-T32 MT SCLCL 06	■	HSK-T32 MT SCLCR 06	■	T32	32	15	65	35				CC.. 0602..
HSK-T32 MT SCLCL 09	■	HSK-T32 MT SCLCR 09	■	T32	32	15	65	35				CC.. 09T3..
HSK-T40 MT SCLCL 06	■	HSK-T40 MT SCLCR 06	■	T40	40	15	75	45				CC.. 0602..
HSK-T40 MT SCLCL 09	■	HSK-T40 MT SCLCR 09	■	T40	40	15	75	45				CC.. 09T3..
HSK-A40 MT SCLCL 06	■	HSK-A40 MT SCLCR 06	■	A40	40	15	75	45				CC.. 0602..
HSK-A40 MT SCLCL 09	■	HSK-A40 MT SCLCR 09	■	A40	40	15	75	45				CC.. 09T3..

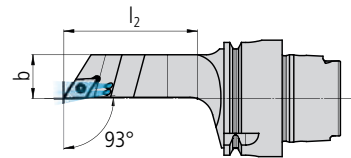
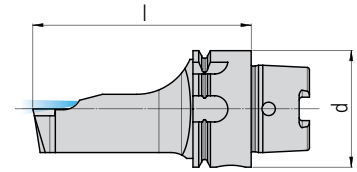
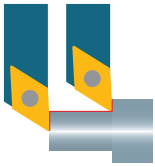

HSK-... MT SDJC... (93°)

Order designation				Form / Size	Dimensions						Inserts	
L		R		HSK	d	b	l	l ₂				□ 201...
HSK-T32 MT SDJCL 07	■	HSK-T32 MT SDJCR 07	■	T32	32	12	65	36				DC.. 0702..
HSK-T32 MT SDJCL 11	■	HSK-T32 MT SDJCR 11	■	T32	32	12.5	65	37				DC.. 11T3..
HSK-T40 MT SDJCL 07	■	HSK-T40 MT SDJCR 07	■	T40	40	15	75	46				DC.. 0702..
HSK-T40 MT SDJCL 11	■	HSK-T40 MT SDJCR 11	■	T40	40	15	75	46				DC.. 11T3..
HSK-A40 MT SDJCL 07	■	HSK-A40 MT SDJCR 07	■	A40	40	15	75	46				DC.. 0702..
HSK-A40 MT SDJCL 11	■	HSK-A40 MT SDJCR 11	■	A40	40	15	75	46				DC.. 11T3..

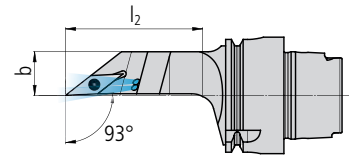
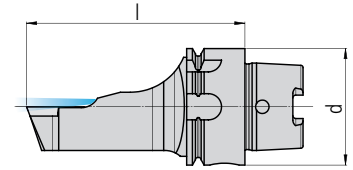
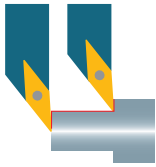

HSK-... MT SVJC... (93°)

Order designation				Form / Size	Dimensions						Inserts	
L		R		HSK	d	b	l	l ₂				□ 259...
HSK-T32 MT SVJCL 07	■	HSK-T32 MT SVJCR 07	■	T32	32	12	65	36				VC.. 0702..
HSK-T32 MT SVJCL 11	■	HSK-T32 MT SVJCR 11	■	T32	32	12	65	36				VC.. 1103..
HSK-T40 MT SVJCL 07	■	HSK-T40 MT SVJCR 07	■	T40	40	15	75	46				VC.. 0702..
HSK-T40 MT SVJCL 11	■	HSK-T40 MT SVJCR 11	■	T40	40	15	75	46				VC.. 1103..
HSK-T40 MT SVJCL 13	■	HSK-T40 MT SVJCR 13	■	T40	40	15	75	46				VC.. 1303..
HSK-A40 MT SVJCL 07	■	HSK-A40 MT SVJCR 07	■	A40	40	15	75	46				VC.. 0702..
HSK-A40 MT SVJCL 11	■	HSK-A40 MT SVJCR 11	■	A40	40	15	75	46				VC.. 1103..
HSK-A40 MT SVJCL 13	■	HSK-A40 MT SVJCR 13	■	A40	40	15	75	46				VC.. 1303..

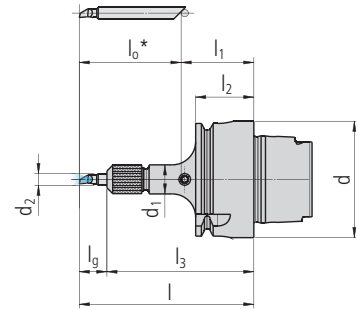
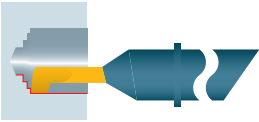

HSK-... SDA.

Order designation				Form / Size	Dimensions								Inserts
N				HSK	d	l	lg	l1	l2	l3	d1	d2	□335...
				HSK-T32 SDA-4	■			T32	32	l ₀ +l ₁	l- ₃	25	20
HSK-T32 SDA-6	■			T32	32	l ₀ +l ₁	l- ₃	25	20	54.5	15	6	SD.6... / SX.6..
HSK-T32 SDA-8	■			T32	32	l ₀ +l ₁	l- ₃	25	20	56.5	18	8	SD.8... / SX.8..
HSK-T40 SDA-4	■			T40	40	l ₀ +l ₁	l- ₃	25	20	50.5	10	4	SD.4... / SX.4..
HSK-T40 SDA-6	■			T40	40	l ₀ +l ₁	l- ₃	25	20	54.5	15	6	SD.6... / SX.6..
HSK-T40 SDA-8	■			T40	40	l ₀ +l ₁	l- ₃	25	20	56.5	18	8	SD.8... / SX.8..
HSK-A40 SDA-4	■			A40	40	l ₀ +l ₁	l- ₃	25	20	50.5	10	4	SD.4... / SX.4..
HSK-A40 SDA-6	■			A40	40	l ₀ +l ₁	l- ₃	25	20	54.5	15	6	SD.6... / SX.6..
HSK-A40 SDA-8	■			A40	40	l ₀ +l ₁	l- ₃	25	20	56.5	18	8	SD.8... / SX.8..

* The length of the insert is variable



PSC 40 MT CUT 500 .

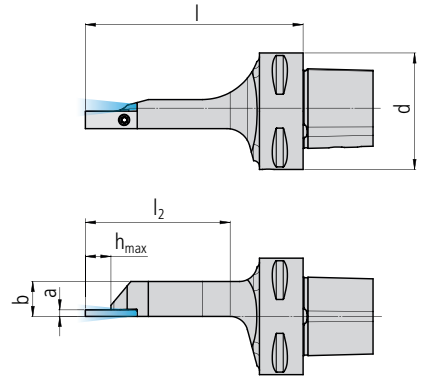

Order designation				Form / Size	Dimensions							Inserts
L		R		PSC	d	b	l	l ₂	a		h _{max}	□45...
PSC 40 MT CUT 500 L	■	PSC 40 MT CUT 500 R	■	40	40	12	75	45	2		8.5	50.



PSC 40 MT CUT 1600 .

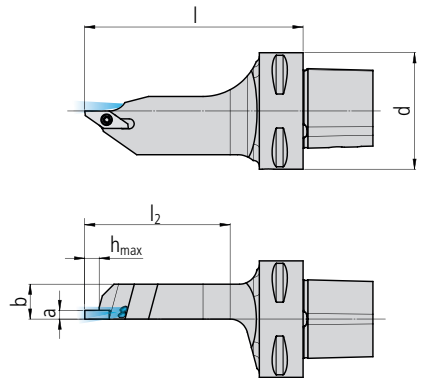

Order designation				Form / Size	Dimensions							Inserts
L		R		PSC	d	b	l	l ₂	a		h _{max}	□49...
PSC 40 MT CUT 1600 L	■	PSC 40 MT CUT 1600 R	■	40	40	12	75	45	3		5	16..

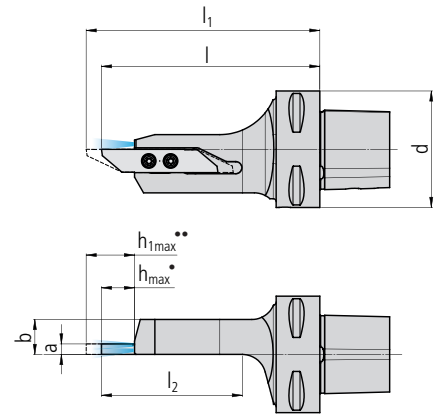
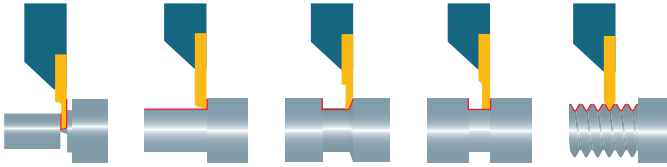

PSC 40 MT CUT 3000 .

Order designation		Form / Size	Dimensions								Inserts
L	R	PSC	d	b	l	l ₁	l ₂	a	h _{max}	h _{1max}	□ 111...
PSC 40 MT CUT 3000 L	PSC 40 MT CUT 3000 R	40	40	12	75	80	45	3.5	10	16	30..

• Short insert; •• Long insert

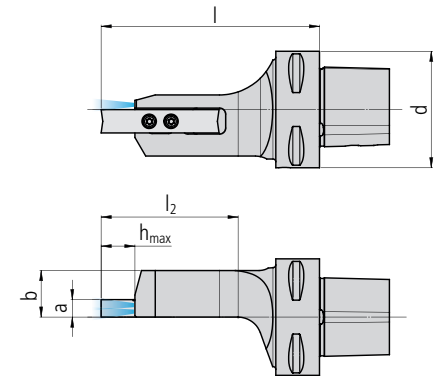

PSC 40 MT CUT 3600 .

Order designation		Form / Size	Dimensions								Inserts
L	R	PSC	d	b	l	l ₂	a		h _{max}	□ 161...	
PSC 40 MT CUT 3600 L	PSC 40 MT CUT 3600 R	40	40	16	75	44	6		10	36..	

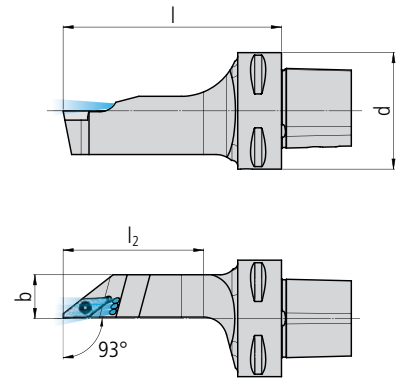
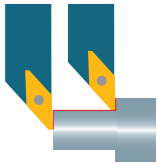

PSC 40 MT SVJP... (93°)

Order designation				Form / Size	Dimensions						Inserts	
L		R		PSC	d	b	l	l ₂				□ 305...
PSC 40 MT SVJPL 10	■	PSC 40 MT SVJPR 10	■	40	40	15	75	50				VP.. 1003..

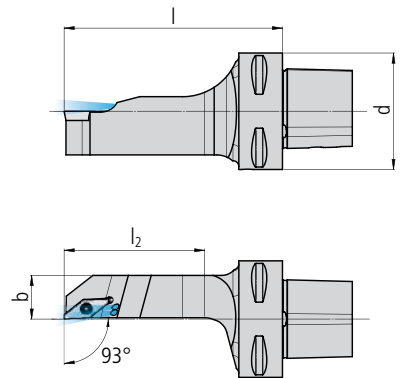

PSC 40 MT SVJP... V (93°)

Order designation				Form / Size	Dimensions						Inserts	
L		R		PSC	d	b	l	l ₂				□ 305...
PSC 40 MT SVJPL 10 V	■	PSC 40 MT SVJPR 10 V	■	40	40	15	75	50				VP.. 1003..

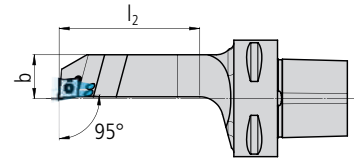
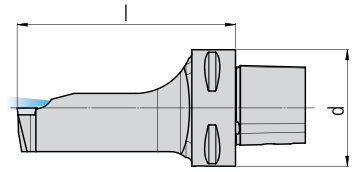
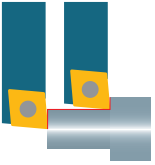

PSC 40 MT SCLC... (95°)

Order designation				Form / Size	Dimensions						Inserts	
L		R		PSC	d	b	l	l ₂				□ 177...
PSC 40 MT SCLCL 06	■	PSC 40 MT SCLCR 06	■	40	40	15	75	43				CC.. 0602..
PSC 40 MT SCLCL 09	■	PSC 40 MT SCLCR 09	■	40	40	15	75	43				CC.. 09T3..

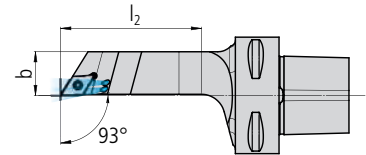
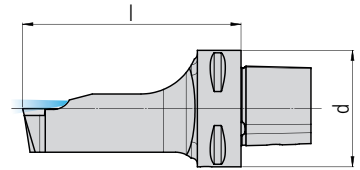
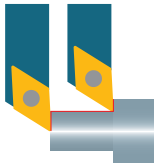

PSC 40 MT SDJC... (93°)

Order designation				Form / Size	Dimensions						Inserts	
L		R		PSC	d	b	l	l ₂				□ 201...
PSC 40 MT SDJCL 07	■	PSC 40 MT SDJCR 07	■	40	40	15	75	43				DC.. 0702..
PSC 40 MT SDJCL 11	■	PSC 40 MT SDJCR 11	■	40	40	15	75	43				DC.. 11T3..

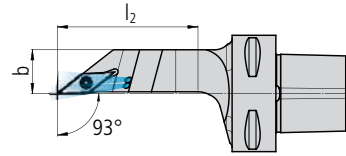
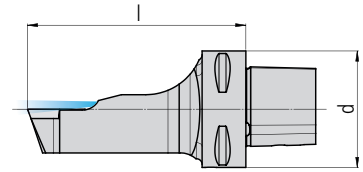
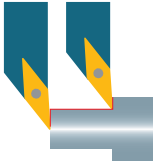

PSC 40 MT SVJC... (93°)

Order designation				Form / Size	Dimensions						Inserts	
L		R		PSC	d	b	l	l ₂				□ 259...
PSC 40 MT SVJCL 07	■	PSC 40 MT SVJCR 07	■	40	40	15	75	45				VC.. 0702..
PSC 40 MT SVJCL 11	■	PSC 40 MT SVJCR 11	■	40	40	15	75	45				VC.. 1103..
PSC 40 MT SVJCL 13	■	PSC 40 MT SVJCR 13	■	40	40	15	75	45				VC.. 1303..

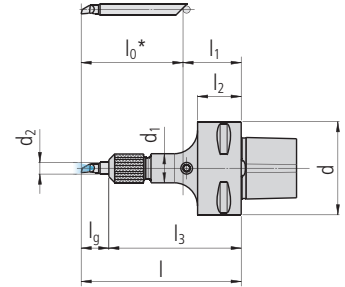
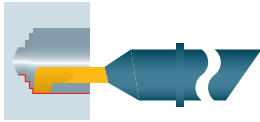

PSC 40 SDA .

Order designation		Form / Size	Dimensions										Inserts
N		PSC	d	l	l ₉	l ₁	l ₂	l ₃	d ₁	d ₂	□ 335...		
			PSC 40 SDA-4	■	40	40	l ₀ +l ₁	l-l ₃	25	20	50.5	10	4
PSC 40 SDA-6	■	40	40	l ₀ +l ₁	l-l ₃	25	20	54.5	15	6	SD.6... / SX.6..		
PSC 40 SDA-8	■	40	40	l ₀ +l ₁	l-l ₃	25	20	56.5	18	8	SD.8... / SX.8..		

* The length of the insert is variable

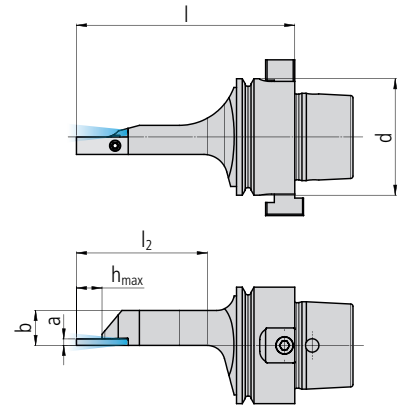
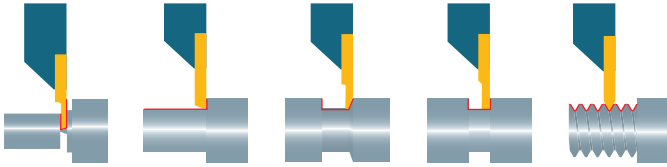

HSK-E40 MT CUT 500 ... WM

Order designation		Form / Size	Dimensions						Inserts
L	R	HSK	d	b	l	l ₂	a	h _{max}	□45...
HSK-E40 MT CUT 500 L WM	HSK-E40 MT CUT 500 R WM	E40	40	12	75	45	2	8.5	50.

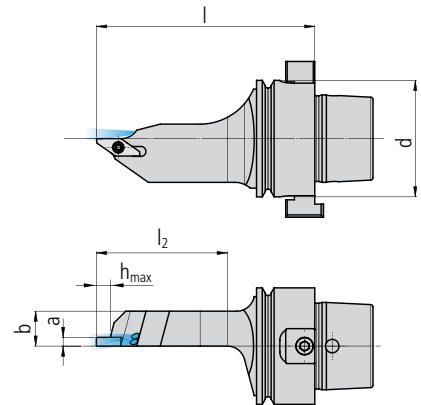

HSK-E40 MT CUT 1600 ... WM

Order designation		Form / Size	Dimensions						Inserts
L	R	HSK	d	b	l	l ₂	a	h _{max}	□49...
HSK-E40 MT CUT 1600 L WM	HSK-E40 MT CUT 1600 R WM	E40	40	12	75	45	3	5	16..

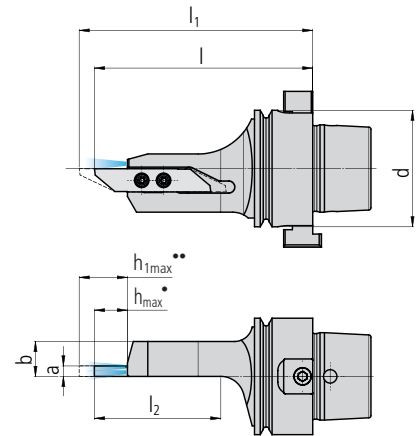

HSK-E40 MT CUT 3000 ... WM

Order designation		Form / Size	Dimensions								Inserts
L	R	HSK	d	b	l	l ₁	l ₂	a	h _{max}	h _{1max}	□ 111...
HSK-E40 MT CUT 3000 L WM	HSK-E40 MT CUT 3000 R WM	E40	40	12	75	80	43	3.5	10	16	30..

• Short insert; •• Long insert

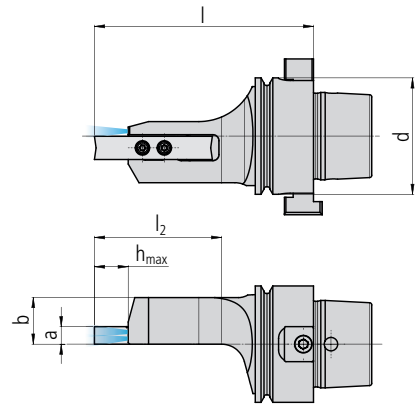

HSK-E40 MT CUT 3600 ... WM

Order designation		Form / Size	Dimensions							Inserts
L	R	HSK	d	b	l	l ₂	a	h _{max}	□ 161...	
HSK-E40 MT CUT 3600 L WM	HSK-E40 MT CUT 3600 R WM	E40	40	16	75	44	6	10	36..	

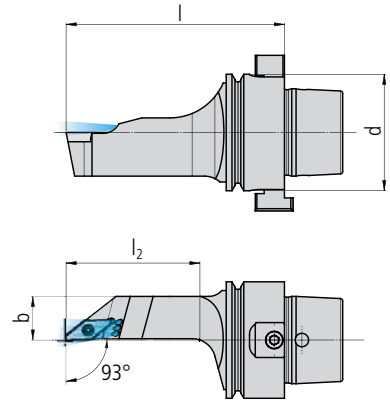
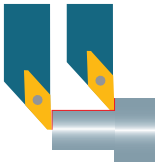

HSK-E40 MT SVJPL... WM (93°)

Order designation				Form / Size	Dimensions				Inserts
L		R		HSK	d	b	l	l ₂	□ 305...
HSK-E40 MT SVJPL 10 WM	■	HSK-E40 MT SVJPR 10 WM	■	E40	40	15	75	46	VP.. 1003..

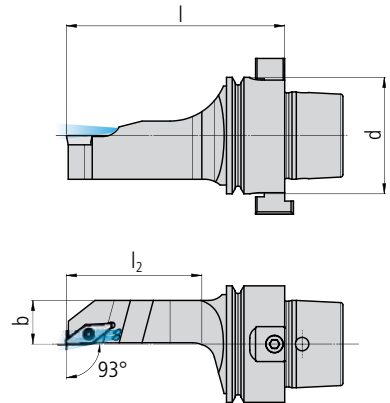

HSK-E40 MT SVJPL... V WM (93°)

Order designation				Form / Size	Dimensions				Inserts
L		R		HSK	d	b	l	l ₂	□ 305...
HSK-E40 MT SVJPL 10 V WM	■	HSK-E40 MT SVJPR 10 V WM	■	E40	40	15	75	46	VP.. 1003..

576

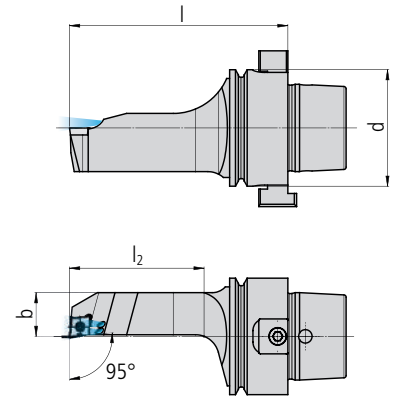
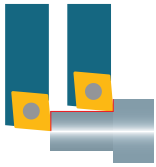

HSK-E40 MT SCLC... WM (95°)

Order designation				Form / Size	Dimensions						Inserts	
L		R		HSK	d	b	l	l ₂				□ 177...
HSK-E40 MT SCLCL 06 WM	■	HSK-E40 MT SCLCR 06 WM	■	E40	40	15	75	47				CC.. 0602..
HSK-E40 MT SCLCL 09 WM	■	HSK-E40 MT SCLCR 09 WM	■	E40	40	15	75	47				CC.. 09T3..

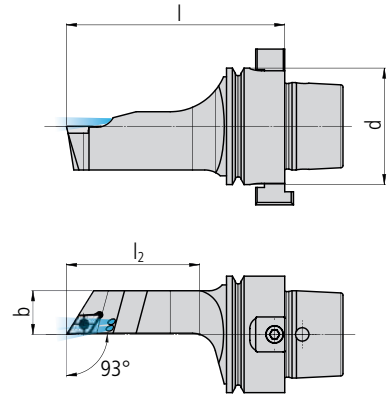
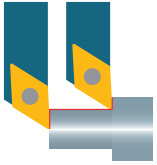

HSK-E40 MT SDJC... WM (93°)

Order designation				Form / Size	Dimensions						Inserts	
L		R		HSK	d	b	l	l ₂				□ 201...
HSK-E40 MT SDJCL 07 WM	■	HSK-E40 MT SDJCR 07 WM	■	E40	40	15	75	46				DC.. 0702..
HSK-E40 MT SDJCL 11 WM	■	HSK-E40 MT SDJCR 11 WM	■	E40	40	15	75	46				DC.. 11T3..

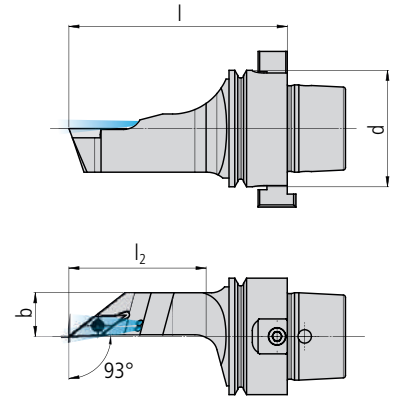
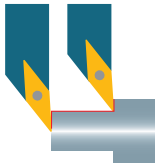

HSK-E40 MT SVJCL... WM (93°)

Order designation				Form / Size	Dimensions						Inserts	
L		R		HSK	d	b	l	l ₂				□ 259...
HSK-E40 MT SVJCL 07 WM	■	HSK-E40 MT SVJCR 07 WM	■	E40	40	15	75	45				VC.. 0702..
HSK-E40 MT SVJCL 11 WM	■	HSK-E40 MT SVJCR 11 WM	■	E40	40	15	75	45				VC.. 1103..
HSK-E40 MT SVJCL 13 WM	■	HSK-E40 MT SVJCR 13 WM	■	E40	40	15	75	45				VC.. 1303..

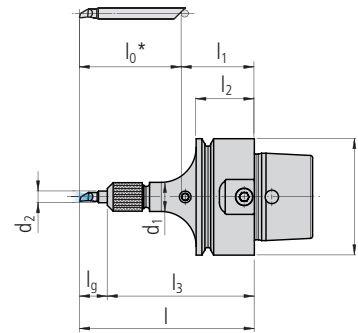
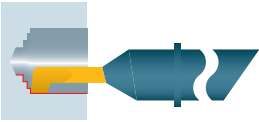

HSK-E40 MT SDA . WM



Order designation				Form / Size	Dimensions								Inserts
N				HSK	d	l	lg	l1	l2	l3	d1	d2	□ 335...
				HSK-E40 MT SDA-4 WM	■			E40	40	l ₀ +l ₁	l-l ₃	25	20
HSK-E40 MT SDA-6 WM	■			E40	40	l ₀ +l ₁	l-l ₃	25	20	54.5	15	6	SD.6... / SX.6..
HSK-E40 MT SDA-8 WM	■			E40	40	l ₀ +l ₁	l-l ₃	25	20	56.5	18	8	SD.8... / SX.8..

* The length of the insert is variable

For holders (CUT/SV/SC/SD) OD turning

Illustration	Description	Dimensions	Order designation	Holder
	TORX screw	M2 × 5.5 T06	MSP 20055 T06	■ ... SV.. 07
		M2.5 × 6 T08	MSP 25060 T08	■ ... CUT 500 ... CUT 1600 ... SC.. 06 ... SD.. 07 ... SV.P 10 ... SV..11
		M3 × 9 T08	MSP 30090 T08	■ ... CUT 3000 ... SV..13
		M3 × 11 TP09	MSP 30110 TP09	■ ... CUT 3600
		M3.5 × 11 T15	MSP 35110 T15	■ ... SC.. 09 ... SD.. 11

For holders (SDA) ID turning

Illustration	Description	Dimensions	Order designation	Holder	Inserts
	Nut	M8 × 0.5	MSP SDA 4M	■ ... SDA-4.	
		M12 × 0.6	MSP SDA 6M	■ ... SDA-6.	
		M14 × 0.75	MSP SDA 8M	■ ... SDA-8.	
	Aligning device		SDA 4X	■ ... SDA-4.	
			SDA 6X	■ ... SDA-6.	
			SDA 8X	■ ... SDA-8.	
	Retaining ring		MSP SDA 4S	■	SD. 4... SX. 4...
			MSP SDA 6S	■	SD. 6... SX. 6...
			MSP SDA 8S	■	SD. 8... SX. 8...

TORX screwdriver 651...

ESCOMATIC machines are known as versatile and flexible automatic turning centers for the low cost manufacture of complex work pieces in small and large batch sizes. Material is fed from the coil with a straightening unit or from a bar loader. UTILIS has developed a range of insert holders for various machine types.

Advantages:

- Elaborate program of toolholders, available from stock
- Nickelized toolholders with heat-treatable steel
- Utilisation of high quality multidec® inserts
- Quick change of inserts in the machine or presetting outside of the machine
- Significant reduction of machine downtimes

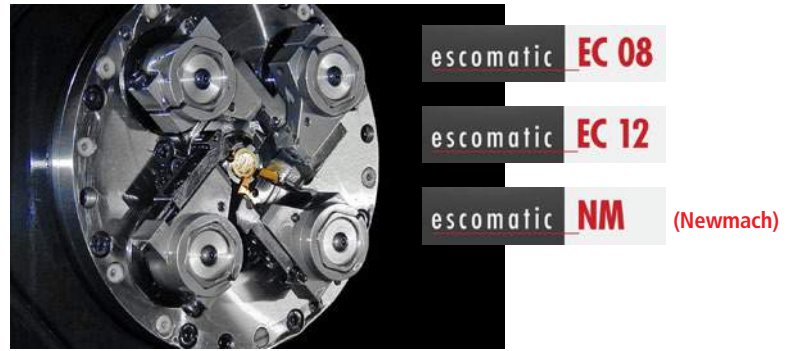

For the rotating tool heads of machine types ECO8, EC12, Newmach NM 64X, NM 6 Flexi, NM 6 TWIN and NM 8, the program includes tool holders which are suitable for multidec®-CUT, multidec®-TOP and ISO standard inserts.



ESCO offers a modification of the existing chuck on the D2, D4 and D5 machine types, where the basic holders for the cranks can be replaced with insert holders. Following this modification, holders for UTILIS inserts can then be attached.

Important: In order to guarantee perfect functionality, modifications may only be made by ESCO. UTILIS only supplies the holders and the corresponding inserts.



The following machine types can be modified:

D2, D2 Flex Speed, D5 Flex Speed, D2-CNC, D2-CNC-UP, D4, D5, D5-CNC, D5-Twin and D5-Ultra



For the machine type D6, we recommend a new exchange kit. This new holder and insert system will replace the old system with monobloc tools.

Overview – multidec®-ESCOMATIC

Technical information		11
Support		584
Holders		585
Replacement and spare parts		589



ESCO D6...

Order designation	Machine type	Holder
ESCO D6-9-38-B	■	ESCO D6-12...

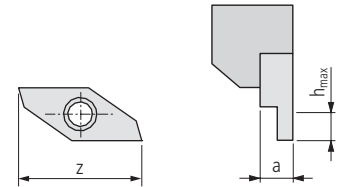

ESCO ... CUT 1600 .

Order designation	Execution			Machine type	Dimensions			Inserts □ 49...
	L	N	R		z	h _{max}	a	
ESCO 503-0679 CUT 1600 R			■	EC 08 / NM 8 Flexi	15	5	3	16...
ESCO 503-0403 CUT 1600 R*			□	EC 08 / NM 8 Flexi	13–14	4–4.5	3	16...
ESCO 403-0875 CUT 1600 R*			■	EC 12	13–14	4–4.5	3	16...
ESCO 303-1711 CUT 1600 R			■	NM 64X / NM 6 Flexi / NM 6 Twin	15	5	3	16...
ESCO 303-2126 CUT 1600 R*			□	NM 64X / NM 6 Flexi / NM 6 Twin	14–15	4.5–5	3	16...
ESCO 303-2125 CUT 1600 R*			□	NM 64X / NM 6 Flexi / NM 6 Twin	14.5–15.5	4.75–5.25	3	16...
ESCO 303-1657 CUT 1600 R*			□	NM 64X / NM 6 Flexi / NM 6 Twin	13–14	4–4.5	3	16...
ESCO D6-12-5451 CUT 1600 R			■	D6	15	5	3	16...
ESCO D6-12-5452 CUT 1600 L	■			D6	15	5	3	16...
ESCO D6-12-5451-1 CUT 1600 R			□	D6	15	5	4	1694... **
ESCO D6-12-5452-1 CUT 1600 L	□			D6	15	5	4	1694... **
ESCO D2-R-6353-1 CUT 1600 R			■	D2, D4, D5	15	5	3	16...
ESCO D2-R-6590-1 CUT 1600 L	■			D2, D4, D5	15	5	3	16...
ESCO D2-R-6353 CUT 1600 R*			□	D2, D4, D5	13–14	4–4.5	3	16...
ESCO D2-R-6590 CUT 1600 L*	□			D2, D4, D5	13–14	4–4.5	3	16...

** Special inserts—multidec4you® □ 600...

* Attention

The total length (z) of the CUT 16... cutting edge is 15 mm. If this length is undershot or exceeded to a significant extent, the travel distance of the holder may no longer be sufficient. In this case, a change to another holder must take place.

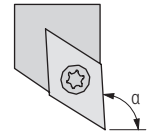

ESCO ... DC ...

Order designation	Execution			Machine type	Dimensions			Inserts □ 201 ...
	L	N	R		α			
ESCO 503-0333 DC 0702 R			■	EC 08 / NM 8 Flexi	92°			DC..0702..
ESCO 503-0629 DC 0702 L	■			EC 08 / NM 8 Flexi	92°			DC..0702..
ESCO 403-0653 DC 0702 R			■	EC 12	92°			DC..0702..
ESCO 303-1760 DC 0702 R			■	NM 64X / NM 6 Flexi / NM 6 Twin	92°			DC..0702..
ESCO D6-12-5458 DC 0702 R			■	D6	92°			DC..0702..
ESCO D6-12-5457 DC 0702 L	■			D6	92°			DC..0702..
ESCO D2-R-6592 DC 0702 R			■	D2, D4, D5	92°			DC..0702..

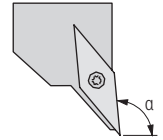
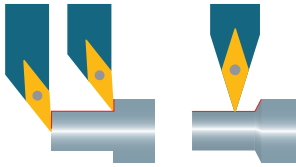

ESCO ... VC ...

Order designation	Execution			Machine type	Dimensions		Inserts □ 259...
	L	N	R		α		
ESCO 503-0262 VC 0702 R			■	EC 08 / NM 8 Flexi	92°		VC..0702.. (R<0.1)
ESCO 503-0483 VC 0702 R			■	EC 08 / NM 8 Flexi	92°		VC..0702.. (R≥0.1)
ESCO 503-0583 VC 0702 L	■			EC 08 / NM 8 Flexi	92°		VC..0702.. (R≥0.1)
ESCO 503-0404 VC 1103 R			■	EC 08 / NM 8 Flexi	92°		VC..1103..
ESCO 303-2127 VC 0702 L	■			NM 64X / NM 6 Flexi / NM 6 Twin	92°		VC..0702.. (R<0.03)
ESCO 303-1637 VC 0702 R			■	NM 64X / NM 6 Flexi / NM 6 Twin	92°		VC..0702.. (R<0.03)
ESCO 303-1640 VC 0702 R			■	NM 64X / NM 6 Flexi / NM 6 Twin	92°		VC..0702.. (R≥0.03)
ESCO D6-12-5455 VC 1103 R			■	D6	92°		VC..1103..
ESCO D6-12-5454 VC 1103 L	■			D6	92°		VC..1103..
ESCO D2-R-6588 VC 0702 R			■	D2, D4, D5	92°		VC..0702.. (R<0.1)
ESCO D2-R-6588-1 VC 0702 R			■	D2, D4, D5	92°		VC..0702.. (R≥0.1)

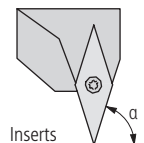

ESCO ... VC ... N

Order designation	Execution			Machine type	Dimensions		Inserts □ 259...
	L	N	R		α		
ESCO 503-0482 VC 0702 N		■		EC 08 / NM 8 Flexi	72.5°		VC..0702..
ESCO 303-1642 VC 0702 N		■		NM 64X / NM 6 Flexi / NM 6 Twin	72.5°		VC..0702..

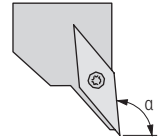
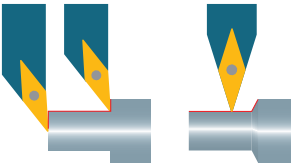

ESCO ... VB ...

Order designation	Execution			Machine type	Dimensions			Inserts
	L	N	R		α			
ESCO 403-0674 VB 1103 R	■		■	EC 12	92°			VB..1103
ESCO 403-0696 VB 1103 L	■			EC 12	92°			VB..1103

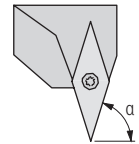

ESCO ... VB ... N

Order designation	Execution			Machine type	Dimensions			Inserts
	L	N	R		α			
ESCO 403-0679 VB 1103 N		■		EC 12	72.5°			VB..1103

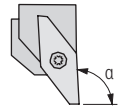

ESCO ... VP ...

Order designation	Execution			Machine type	Dimensions			Inserts □ 305...
	L	N	R		α			
ESCO 503-0335 VP 1003 R			■	EC 08 / NM 8 Flexi	92°			VP..1003..
ESCO 403-0293 VP 1003 R			■	EC 12	90°			VP..1003..
ESCO 403-0594 VP 1003 R			■	EC 12	92°			VP..1003..
ESCO 403-0652 VP 1003 L	■			EC 12	92°			VP..1003..
ESCO D6-12-5456 VP 1003 R			■	D6	92°			VP..1003..
ESCO D6-12-5453 VP 1003 L	■			D6	92°			VP..1003..

Replacement and spare parts

Illustration	Description	Dimensions	Order designation	Holder
	TORX screw	M2 × 5.5 T06	MSP 20055 T06 ■	ESCO... VC 0702 .
		M2.5 × 6 T08	MSP 25060 T08 ■	ESCO... CUT 1600 . ESCO... VP 1003 . ESCO... VB 1103 . ESCO... VC 1103 . ESCO... DC 0702 .
	Special allen head screw	M4 × 12	ESCO D6-4-409 IB3 ■	ESCO D6-9-38-B
	Socket head screw	M4 × 10	MSP 40100 IB3 ■	ESCO D6-12...
		M4 × 12	MSP 40120 IB3 ■	
	Set screw	M3 × 25	MSP 30250 IB1.5 ■	ESCO D6-9-38-B
	Allen key	SW 1.5	MSP IB1.5 ■	MSP 30... IB1.5
		SW 3	MSP IB3 ■	MSP 40... IB3

Cut-off operation near the spindle or the sub-spindle is frequently difficult with standard-tool holders. The cutting edge is too far away or the tool holder collides with the spindle. Adapted special tool holders are the solution in this case.

This program proposes to use multidec®-CUT and -TOP inserts, adapted tool holders and modules for machines of DECO 7, DECO 10, EvoDECO 10, DECO 13, EvoDECO 16, DECO 20, DECO 26 and EvoDECO 32.

TORNOS



Advantages:

- Adapted tool-holders with internal cooling, nickel plated and made from heat treated steel, available from stock
- Increased stability by direct attachment of tool holders on the machine base plate
- Cutting edge near the spindle/sub-spindle
- Cut-off of small parts without problems
- Utilisation of high quality multidec®-CUT inserts

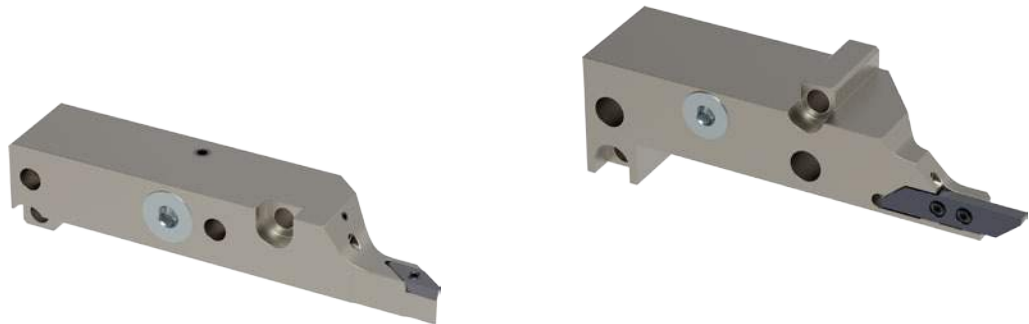

Overview – multidec®-TORNOS DECO

Technical information

11

Holders



592

Replacement and spare parts



598

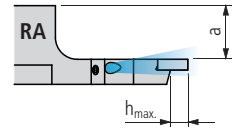
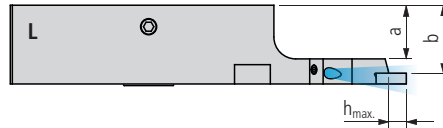
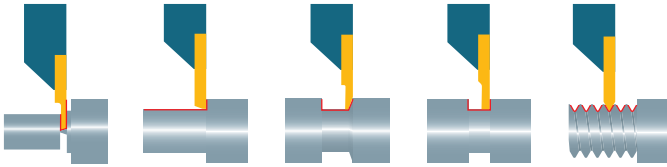

DECO... 7/10 CUT 1600 ...

Order designation				Dimensions			Machine type	Inserts
L		R		a	b	h_{max}		□ 49...
DECO/EVO 7/10 CUT 1600 LIC	■	DECO/EVO 7/10 CUT 1600 RA IC	■	15	19	5	DECO 7/10, EvoDECO 10	16...

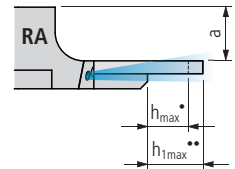
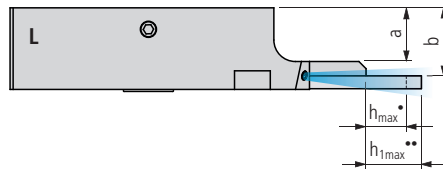

DECO... 7/10 CUT 3000 ...

Order designation				Dimensions				Machine type	Inserts
L		R		a	b	h_{max}	h_{1max}		□ 111...
DECO/EVO 7/10 CUT 3000 LIC	■	DECO/EVO 7/10 CUT 3000 RA IC	■	15	19	10	—	DECO 7/10, EvoDECO 10	30 ...

• Short insert; •• Long insert

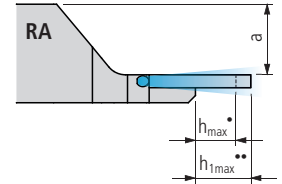
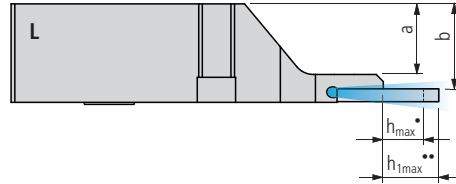
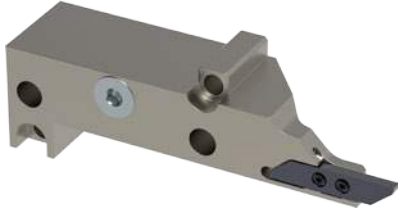

DECO... 13/16 CUT 3000 ...

Order designation				Dimensions				Machine type	Inserts
L		R		a	b	h _{max}	h _{1max}		□ 111...
DECO/EVO 13/16 CUT 3000 L IC	■	DECO/EVO 13/16 CUT 3000 RA IC	■	25	29	10	–	DECO 13, EvoDECO 16	30...

• Short insert; •• Long insert

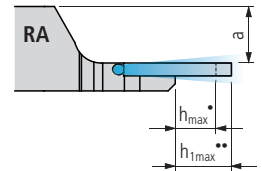
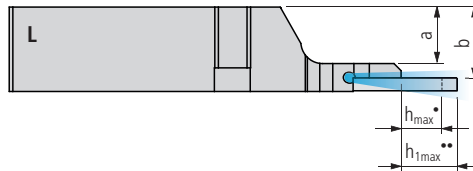

DECO... 20/26/32 CUT 3000 ...

Order designation				Dimensions				Machine type	Inserts
L		R		a	b	h _{max}	h _{1max}		□ 111...
DECO/EVO 20/26/32 CUT 3000 L IC	■	DECO/EVO 20/26/32 CUT 3000 RA IC	■	20	24	10	16	DECO 20/26, Evo DECO 32	30...

• Short insert; •• Long insert

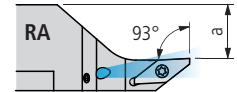
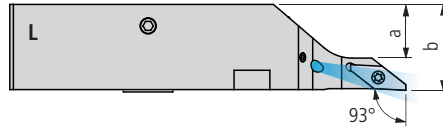
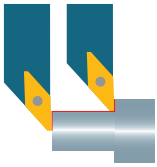

DECO... 7/10 SVJP ... (93°)

Order designation		Dimensions		Machine type	Inserts
L	R	a	b		□ 305...
DECO/EVO 7/10 SVJP L IC	DECO/EVO 7/10 SVJP RA IC	15	24	DECO 7/10, EvoDECO 10	VP 1003..

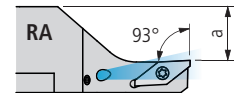
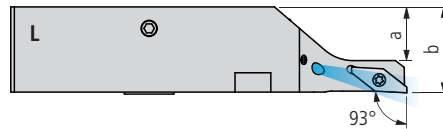

DECO... 7/10 SVJP ... V (93°)

Order designation		Dimensions		Machine type	Inserts
L	R	a	b		□ 305...
DECO/EVO 7/10 SVJP L V IC	DECO/EVO 7/10 SVJP RA V IC	15	24	DECO 7/10, EvoDECO 10	VP 1003..

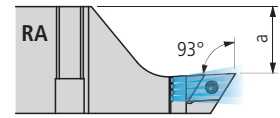
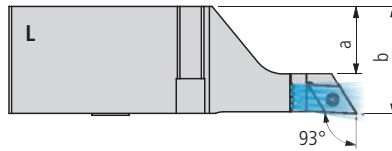
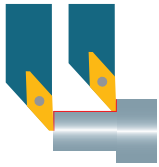

DECO... 13/16 SDJC ... (93°)

Order designation		Dimensions		Machine type	Inserts
L	R	a	b		□ 201...
DECO/EVO 13/16 SDJC L IC	DECO/EVO 13/16 SDJC RA IC	25	40	DECO 13, EvoDECO 16	DC.. 11T3..

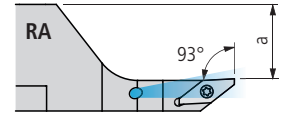
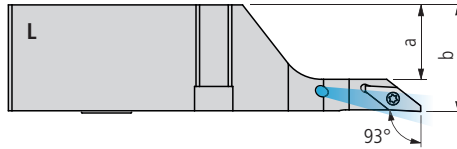
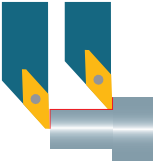

DECO... 13/16 SVJP ... (93°)

Order designation		Dimensions		Machine type	Inserts
L	R	a	b		□ 305...
DECO/EVO 13/16 SVJP L IC	DECO/EVO 13/16 SVJP RA IC	25	34	DECO 13, EvoDECO 16	VP 1003..

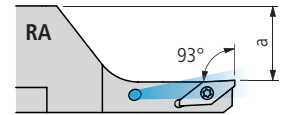
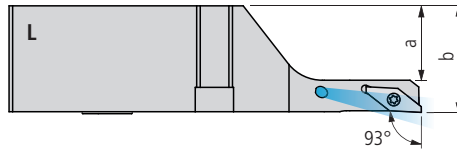

DECO... 13/16 SVJP ... V (93°)

Order designation		Dimensions		Machine type	Inserts
L	R	a	b		□ 305...
DECO/EVO 13/16 SVJP L V IC	DECO/EVO 13/16 SVJP RA V IC	25	34	DECO 13, EvoDECO 16	VP 1003..

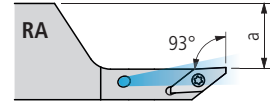
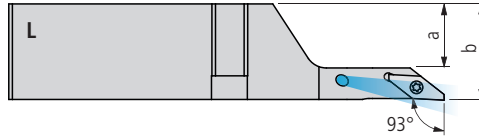
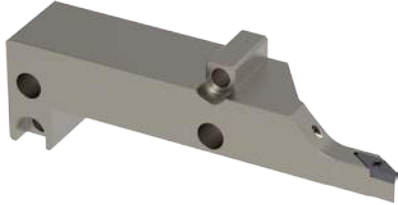
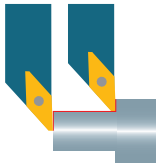



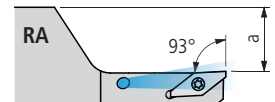
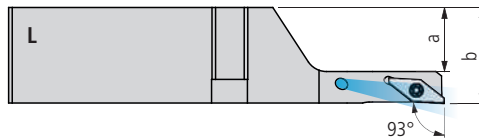

DECO... 20/26/32 SVJP ... (93°)

Order designation				Dimensions		Machine type	Inserts
L		R		a	b		□ 305...
DECO/EVO 20/26/32 SVJP L IC	■	DECO/EVO 20/26/32 SVJP RA IC	■	20	29	DECO 20/26, EvoDECO 32	VP 1003..

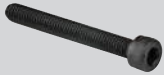

DECO... 20/26/32 SVJP ... V (93°)

Order designation				Dimensions		Machine type	Inserts
L		R		a	b		□ 305...
DECO/EVO 20/26/32 SVJP L V IC	■	DECO/EVO 20/26/32 SVJP RA V IC	■	20	29	DECO 20/26, EvoDECO 32	VP 1003..

Illustration	Description	Dimensions	Order designation	Holder
	TORX screw	M2.5 × 6 T08	MSP 25060 T08	■ DECO/EVO... CUT 1600.. DECO/EVO...SVJR..
		M3 × 9 T08	MSP 30090 T08	■ DECO/EVO... CUT 3000..
	Cylindrical pin	ø5 h6 × 24	MSP Z5524	■ DECO/EVO 7/10...
		ø5 h6 × 24	MSP Z5524 special	■ DECO/EVO 7/10...
	Socket head screw	M5 × 30 IB4	MSP 50300 IB4	■ DECO/EVO 7/10...
		M6 × 40 IB5	MSP 60400 IB5	■ DECO/EVO 13/16...
		M6 × 35 IB5	MSP 60350 IB5	■ DECO/EVO 20/26/32...
	Allen key	SW 4	MSP IB4	■ MSP 50... IB4
		SW 5	MSP IB5	■ MSP 60... IB5
	Screw plug	G $\frac{1}{8}$ " IB5	MSP VSR G1/8 IB5	■ DECO/EVO 7/10... DECO/EVO 13/16...

TORX screwdriver  651...

Product description

Development and production of multidec® tools for your own specific needs.

Customer's situation

A special machining situation is very difficult or impossible to be resolved by using tools from the standard multidec® range. For this, a special tool or a standard tool with a different dimension is required.

UTILIS solution

After detailed consultation, we will develop and make the best multidec® solution for your particular needs. Normally this will be done using standard blanks which enable the special tools to be produced and delivered quickly and at reasonable cost. The familiar multidec® quality is of course always guaranteed.

Advantages:

- UTILIS know-how and quality, even for special solutions
- Targeted new development in accordance with customer requirements is possible
- Construction with many years of experience
- Modern manufacturing with the best machinery





Equipping with PCD, CVD diamond or CBN cutter possible by request.

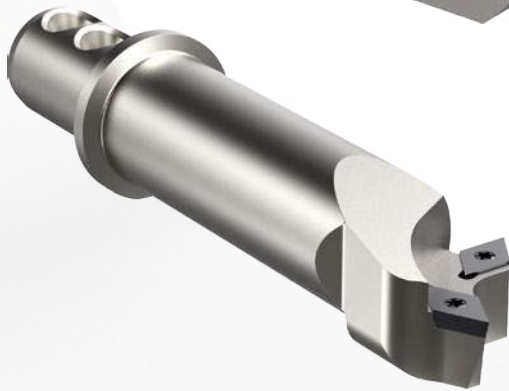
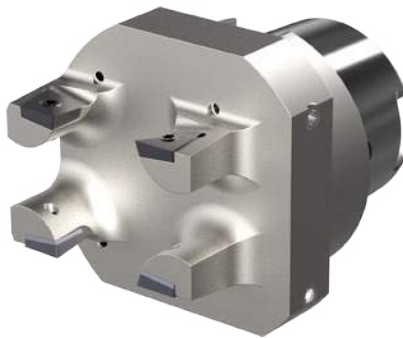

Inquiry

multidec4you®

The feasibility study starts in the technical office when your inquiry is received and the first estimate of the costs is then worked out with the involvement of the production. Competent product managers will prepare a tailor-made solution for you and provide you with a quotation.

Accessories

Accessories are well-suited products to be used in combination with cutting tools in different machining applications. They aren't related to a specific tool system.



Clamping and cooling system – multidec®-LUB



Coolant system

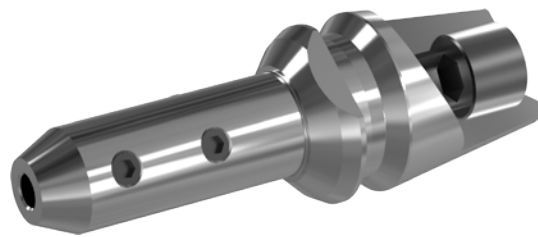

Monoblock ER tool holder – multidec®-TAPER-IN



Screwdriver



Collets



Reduction sleeves

Overview – Accessories

Technical information

11

Clamping and cooling system

Overview – multidec®-LUB



605

Coolant system

Overview of high pressure and low pressure

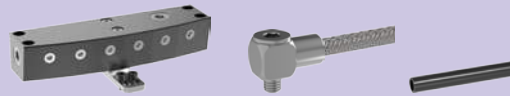

619

Monoblock ER tool holder

Overview – multidec®-TAPER-IN

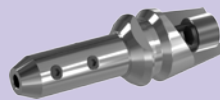

643

Special tools – multidec4you®

600

Screwdriver

Overview



651

Collets



654

Reduction sleeves



655

The multidec®-LUB clamping shim directs the coolant precisely onto the tool insert, even at low pressure. The flexible stop allows for the tool holder to be replaced safely and quickly. The supply of coolant under high and low pressure is made through a distributor block or directly in the multidec®-LUB clamping shim.

Coolant distributors with two to eight outlets, hoses in a range of different versions and lengths, plus diverse fittings and quick couplings are available as accessories for complete high-pressure and low-pressure solutions.

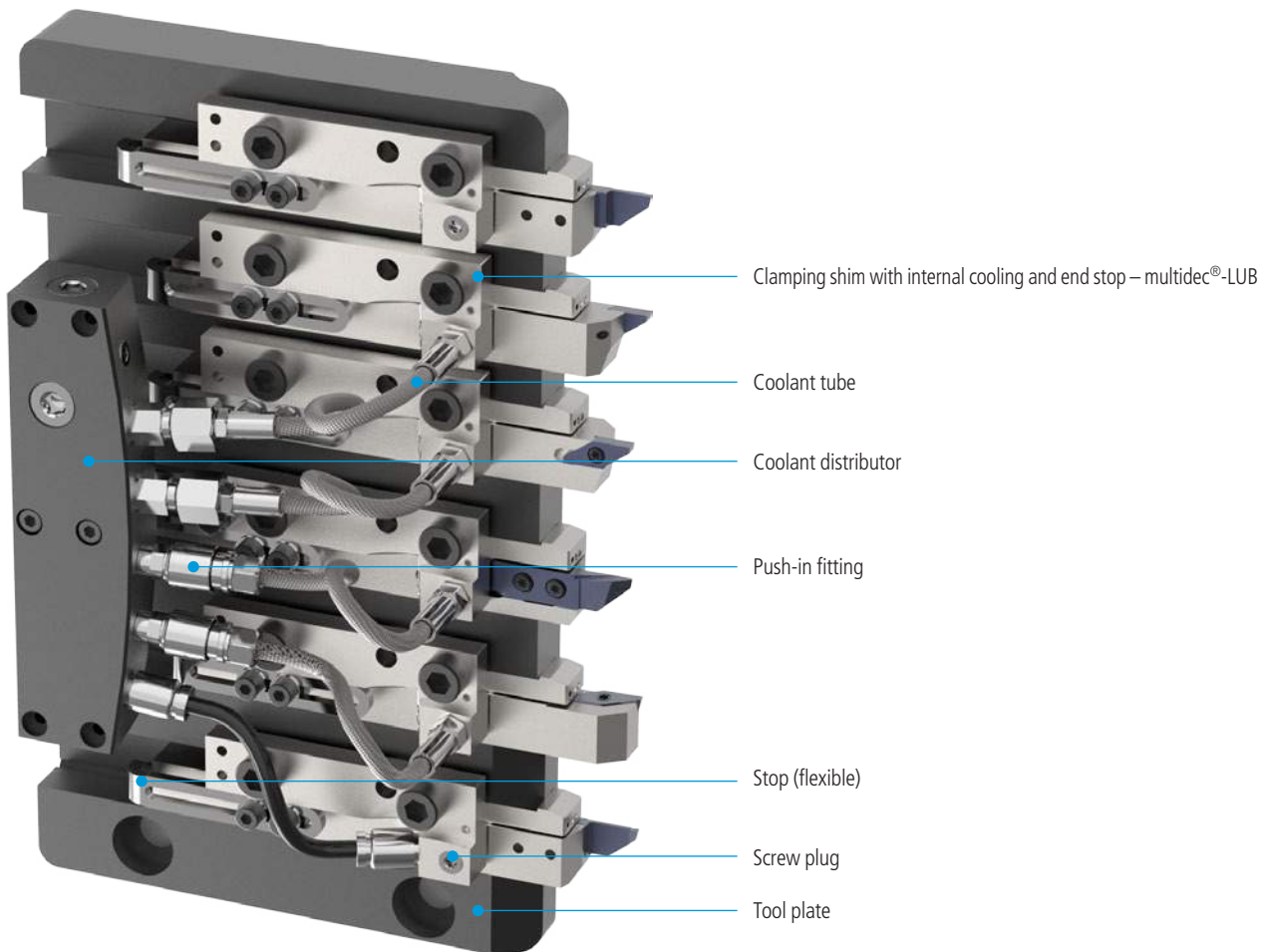

Benefits:

- Simple installation through replacement of the original clamping shim with the multidec®-LUB clamping shim
- The service life of the insert is increased as the removal of chips and heat is improved thanks to the precise positioning of the cooling on the cutting edge
- Increased process reliability
- Use of the clamping shim at pressures of 30 to 200 bar or 435 to 2900 psi
- Quick and safe replacement of the insert thanks to integrated stop
- Tool holders without internal cooling (IC) can continue to be used
- The clamping shim can be used under high and low pressure
- For right-hand and left-hand tool holders
- The clamping shim has two connecting options for the coolant supply
- Different coolant distributors, hoses and push-in fittings for high and low pressure
- Torque screwdriver for precise clamping of the tools

Overview – multidec®-LUB

Technical information

11

Clamping shims

608



Replacement and spare parts

616

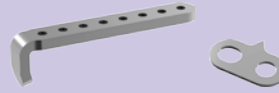

Order guideline

617

The designation of a clamping wedge contains all of the important information, which is put together in accordance with the following system:

Clamping shim

MLU CI - 12 - R-R IC - F

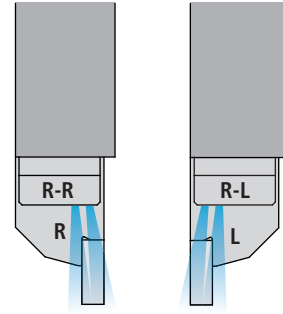
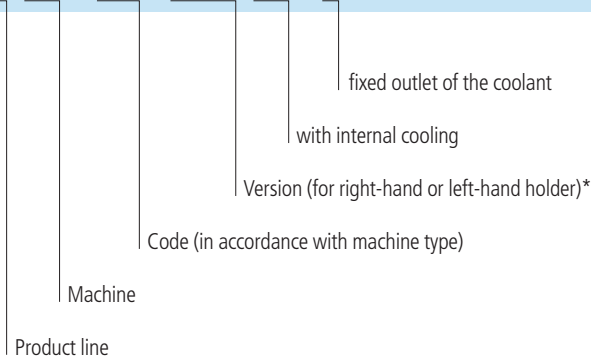

* R-R: Clamping shim for right-hand holders "R"
R-L: Clamping shim for left-hand holders "L"



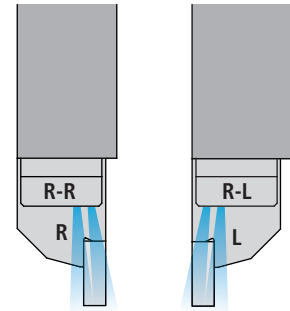

MLU CI-... IC F (CITIZEN)

R-R: Clamping shim for right-hand holders "R"; R-L: Clamping shim for left-hand holders "L"

Type of machine	Tool plate	Holder	Positions	Order designation		
				R	L	606
R07	QTF4308	8×8	T11–T12	MLU CI-12 R-R IC-F	MLU CI-12 R-L IC-F	
K12	BTF1012	12×12	T1–T6	MLU CI-01 R-R IC-F	MLU CI-01 R-L IC-F	
	GTF7010	10×10	T1–T6	MLU CI-09 R-R IC-F	MLU CI-09 R-L IC-F	
K12 E	BTF1010	10×10	T1–T7	MLU CI-02 R-R IC-F	MLU CI-02 R-L IC-F	
L12	GTF7010	10×10	T1–T6	MLU CI-09 R-R IC-F	MLU CI-09 R-L IC-F	
	GTF7010 L	3/8" (9.525)		MLU CI-07 R-R IC-F	MLU CI-07 R-L IC-F	
	GTF7020	8×8		MLU CI-10 R-R IC-F	MLU CI-10 R-L IC-F	
C16	GTF6010	10×10	T1–T6	MLU CI-02 R-R IC-F	MLU CI-02 R-L IC-F	
K16	BTF1010	10×10	T1–T7	MLU CI-02 R-R IC-F	MLU CI-02 R-L IC-F	
	BTF1012	12×12	T1–T6	MLU CI-01 R-R IC-F	MLU CI-01 R-L IC-F	
K16 E	GTF5110	10×10	T1–T5	MLU CI-02 R-R IC-F	MLU CI-02 R-L IC-F	
L16	BTF1012	12×12	T1–T6	MLU CI-01 R-R IC-F	MLU CI-01 R-L IC-F	
M16	BTF3110	10×10	T1–T4	MLU CI-14 R-R IC-F	MLU CI-14 R-L IC-F	
	BTF1012	12×12	T1–T6	MLU CI-01 R-R IC-F	MLU CI-01 R-L IC-F	
A20	GTF5110	10×10	T1–T5	MLU CI-02 R-R IC-F	MLU CI-02 R-L IC-F	
	BTF1012	12×12	T1–T6	MLU CI-01 R-R IC-F	MLU CI-01 R-L IC-F	
	BTF2413			1/2" (12.7)	T2–T5	MLU CI-05 R-R IC-F
A20 L	BTF2212	12×12	T2–T5	MLU CI-01 R-R IC-F	MLU CI-01 R-L IC-F	
	BTF2213	1/2" (12.7)		MLU CI-03 R-R IC-F	MLU CI-03 R-L IC-F	
	BTF2412	12×12		MLU CI-01 R-R IC-F	MLU CI-01 R-L IC-F	
L20	BTF2413	1/2" (12.7)	T2–T5	MLU CI-03 R-R IC-F	MLU CI-03 R-L IC-F	
	GTF3113		T2–T6	MLU CI-03 R-R IC-F	MLU CI-03 R-L IC-F	
	GTF3612	12×12	T2–T5	MLU CI-01 R-R IC-F	MLU CI-01 R-L IC-F	
			T1 (cut off)	MLU CI-08 R-R IC-F	MLU CI-08 R-L IC-F	
		5/8" (15.875)	T1 (cut off)	MLU CI-08 R-R IC-F	MLU CI-08 R-L IC-F	
	GTF3812	16×16	T1 (cut off)	MLU CI-08 R-R IC-F	MLU CI-08 R-L IC-F	
L20 E	GTF3612	12×12	T1–T6	MLU CI-01 R-R IC-F	MLU CI-01 R-L IC-F	
		5/8" (15.875)	T2–T5	MLU CI-01 R-R IC-F	MLU CI-01 R-L IC-F	
	16×16	T1 (cut off)	MLU CI-08 R-R IC-F	MLU CI-08 R-L IC-F		
	GTF3613	5/8" (15.875)	T1–T5	MLU CI-08 R-R IC-F	MLU CI-08 R-L IC-F	
L20 X	BTF2413	1/2" (12.7)	T2–T5	MLU CI-11 R-R IC-F	MLU CI-11 R-L IC-F	
		5/8" (15.875)	T2–T5	MLU CI-03 R-R IC-F	MLU CI-03 R-L IC-F	
	16×16	T1 (cut off)	MLU CI-08 R-R IC-F	MLU CI-08 R-L IC-F		
	GTF3612	12×12	T2–T5	MLU CI-01 R-R IC-F	MLU CI-01 R-L IC-F	
			T1 (cut off)	MLU CI-08 R-R IC-F	MLU CI-08 R-L IC-F	
		5/8" (15.875)	T2–T5	MLU CI-01 R-R IC-F	MLU CI-01 R-L IC-F	
16×16	T1 (cut off)	MLU CI-08 R-R IC-F	MLU CI-08 R-L IC-F			
M20	GTF2513	12×12	T1–T5	MLU CI-01 R-R IC-F	MLU CI-01 R-L IC-F	

Continuation

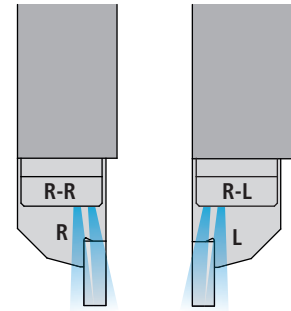

MLU CI-... IC F (CITIZEN)

R-R: Clamping shim for right-hand holders "R"; R-L: Clamping shim for left-hand holders "L"

Type of machine	Tool plate	Holder	Positions	Order designation			
				R	L	606	
L25	GTF4016	16×16	T11–T15	MLU CI-08 R-R IC-F	■	MLU CI-08 R-L IC-F	■
A32		5/8" (15.875)	T1–T6	MLU CI-08 R-R IC-F	■	MLU CI-08 R-L IC-F	■
		16×16		MLU CI-08 R-R IC-F	■	MLU CI-08 R-L IC-F	■
L32	GTF4016	16×16	T11–T15	MLU CI-08 R-R IC-F	■	MLU CI-08 R-L IC-F	■
M32	GTF5216	5/8" (15.875)	T1–T5	MLU CI-08 R-R IC-F	■	MLU CI-08 R-L IC-F	■
		16×16		MLU CI-08 R-R IC-F	■	MLU CI-08 R-L IC-F	■
	GTF5816	MLU CI-08 R-R IC-F		■	MLU CI-08 R-L IC-F	■	
M32 V	GTF5216L	5/8" (15.875)	T1–T5	MLU CI-08 R-R IC-F	■	MLU CI-08 R-L IC-F	■
		16×16		MLU CI-08 R-R IC-F	■	MLU CI-08 R-L IC-F	■
M416-V	GTF5210	10×10	T1–T5	MLU CI-02 R-R IC-F	■	MLU CI-02 R-L IC-F	■
M416-VIII	GTF5210	10×10	T1–T5	MLU CI-02 R-R IC-F	■	MLU CI-02 R-L IC-F	■
L4-25	GTF4516	5/8" (15.875)	T11–T15	MLU CI-08 R-R IC-F	■	MLU CI-08 R-L IC-F	■
M432-V	GTF5816	5/8" (15.875)	T1–T5	MLU CI-08 R-R IC-F	■	MLU CI-08 R-L IC-F	■
		16×16		MLU CI-08 R-R IC-F	■	MLU CI-08 R-L IC-F	■
M432-VII	GTF5816	5/8" (15.875)	T1–T5	MLU CI-08 R-R IC-F	■	MLU CI-08 R-L IC-F	■
		16×16		MLU CI-08 R-R IC-F	■	MLU CI-08 R-L IC-F	■
M432-VIII	GTF5816	5/8" (15.875)	T1–T5	MLU CI-08 R-R IC-F	■	MLU CI-08 R-L IC-F	■
		16×16		MLU CI-08 R-R IC-F	■	MLU CI-08 R-L IC-F	■

Scope of delivery: Clamping shim with stop

Coolant system 619...
 Torque screwdriver 651...

Attention

Tighten the multidec®-LUB clamping shim using the torque screwdriver according to the marking on the shim.

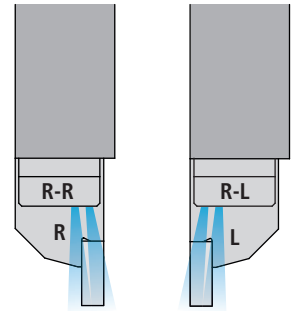

MLU DO-... IC F (DOOSAN)

R-R: Clamping shim for right-hand holders "R"; **R-L:** Clamping shim for left-hand holders "L"

Type of machine	Tool plate	Holder	Positions	Order designation	606
Puma ST20G		12 × 12	T1–T6	<div style="display: flex; justify-content: space-around;"> <div style="text-align: center;"> R </div> <div style="text-align: center;"> L </div> </div>	<div style="display: flex; justify-content: space-around;"> MLU DO-01 R-R IC-F ■ MLU DO-01 R-L IC-F ■ </div>

MLU GM-... IC F (GILDEMEISTER/DMG)

Type of machine	Tool plate	Holder	Positions	Order designation	606
Sprint 20		12 × 12	T1–T5	<div style="display: flex; justify-content: space-around;"> <div style="text-align: center;"> R </div> <div style="text-align: center;"> L </div> </div>	<div style="display: flex; justify-content: space-around;"> MLU GM-01 R-R IC-F ■ MLU GM-01 R-L IC-F ■ </div>
Sprint 32/42	(Plate 1)	16 × 16	T1–T5	<div style="display: flex; justify-content: space-around;"> <div style="text-align: center;"> R </div> <div style="text-align: center;"> L </div> </div>	<div style="display: flex; justify-content: space-around;"> MLU GM-02 R-R IC-F ■ MLU GM-02 R-L IC-F ■ </div>
linear classic	(Plate 2)		T6–T8	<div style="display: flex; justify-content: space-around;"> <div style="text-align: center;"> R </div> <div style="text-align: center;"> L </div> </div>	<div style="display: flex; justify-content: space-around;"> MLU GM-03 R-R IC-F ■ MLU GM-03 R-L IC-F ■ </div>

Scope of delivery: Clamping shim with stop

Coolant system 619...
 Torque screwdriver 651...

Attention
 Tighten the multidec®-LUB clamping shim using the torque screwdriver according to the marking on the shim.

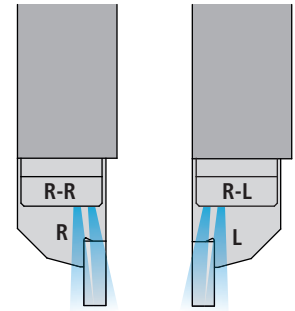

MLU HA-... IC F (HANWHA)

R-R: Clamping shim for right-hand holders "R"; **R-L:** Clamping shim for left-hand holders "L"

Type of machine	Tool plate	Holder	Positions	Order designation		606
				R	L	
XD12 J		12 × 12		MLU HA-01 R-R IC-F	MLU HA-01 R-L IC-F	■
SL16S		12 × 12		MLU HA-01 R-R IC-F	MLU HA-01 R-L IC-F	■
XD20H		12 × 12	T1–T6	MLU HA-02 R-R IC-F	MLU HA-02 R-L IC-F	■
XD20J		12 × 12	T1–T6	MLU HA-02 R-R IC-F	MLU HA-02 R-L IC-F	■
XD38H II		16 × 16	T1–T5	MLU HA-05 R-R IC-F	MLU HA-05 R-L IC-F	■
SL200		12 × 12	T1–T6	MLU HA-02 R-R IC-F	MLU HA-02 R-L IC-F	■

MLU MI-... IC F (MIYANO)

Type of machine	Tool plate	Holder	Positions	Order designation		606
				R	L	
BX-26 S		16 × 16	T1–T6	MLU MI-01 R-R IC-F	MLU MI-01 R-L IC-F	■

Scope of delivery: Clamping shim with stop

- Coolant system 619...
- Torque screwdriver 651...

Attention

Tighten the multidec®-LUB clamping shim using the torque screwdriver according to the marking on the shim.

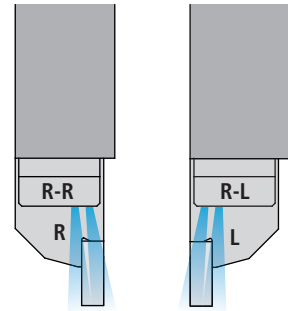

MLU ST-... IC F (STAR)

R-R: Clamping shim for right-hand holders "R"; **R-L:** Clamping shim for left-hand holders "L"

Type of machine	Tool plate	Holder	Positions	Order designation		
				R	L	606
SR-10 J	22-0100629-00 691-01	8 × 8	T1–T6	MLU ST-01 R-R IC-F	MLU ST-01 R-L IC-F	
SB-12 R	0M103-00	12 × 12	T1–T6	MLU ST-16 R-R IC-F	MLU ST-16 R-L IC-F	
SB-12 R Type G	0M104	10 × 10	T1–T5	MLU ST-14 R-R IC-F	MLU ST-14 R-L IC-F	
SV-12	22-0100181-01	12 × 12	T3–T5	MLU ST-10 R-R IC-F	MLU ST-10 R-L IC-F	
			T1–T2 (cut off)	MLU ST-11 R-R IC-F	MLU ST-11 R-L IC-F	
		½" (12.7)	T3–T5	MLU ST-10 R-R IC-F	MLU ST-10 R-L IC-F	
			T1–T2 (cut off)	MLU ST-11 R-R IC-F	MLU ST-11 R-L IC-F	
	24-0002928-03	12 × 12	T3–T5	MLU ST-10 R-R IC-F	MLU ST-10 R-L IC-F	
			T1–T2 (cut off)	MLU ST-11 R-R IC-F	MLU ST-11 R-L IC-F	
		½" (12.7)	T3–T5	MLU ST-10 R-R IC-F	MLU ST-10 R-L IC-F	
			T1–T2 (cut off)	MLU ST-11 R-R IC-F	MLU ST-11 R-L IC-F	
	421-01	12 × 12	T3–T5	MLU ST-10 R-R IC-F	MLU ST-10 R-L IC-F	
			T1–T2 (cut off)	MLU ST-11 R-R IC-F	MLU ST-11 R-L IC-F	
		½" (12.7)	T3–T5	MLU ST-10 R-R IC-F	MLU ST-10 R-L IC-F	
			T1–T2 (cut off)	MLU ST-11 R-R IC-F	MLU ST-11 R-L IC-F	
SW-12 RII	0M104	10 × 10	T1–T5	MLU ST-14 R-R IC-F	MLU ST-14 R-L IC-F	
SB-16	481-02	12 × 12	T2–T6	MLU ST-07 R-R IC-F	MLU ST-07 R-L IC-F	
SB-16 C	630.62.00	12 × 12	T1–T5	MLU ST-07 R-R IC-F	MLU ST-07 R-L IC-F	
SR-16 R	541-01	12 × 12	T1–T6	MLU ST-07 R-R IC-F	MLU ST-07 R-L IC-F	
SB-20 R	0M101	12 × 12	T2–T6	MLU ST-07 R-R IC-F	MLU ST-07 R-L IC-F	
			T1 (cut off)	MLU ST-08 R-R IC-F	MLU ST-08 R-L IC-F	
SR-20 J	0E0-62	12 × 12	T2–T6	MLU ST-07 R-R IC-F	MLU ST-07 R-L IC-F	
	T1 (cut off)		MLU ST-08 R-R IC-F	MLU ST-08 R-L IC-F		
	T2–T6		MLU ST-07 R-R IC-F	MLU ST-07 R-L IC-F		
	T1 (cut off)		MLU ST-08 R-R IC-F	MLU ST-08 R-L IC-F		
	T2–T6		MLU ST-07 R-R IC-F	MLU ST-07 R-L IC-F		
22-0100679-00		T1 (cut off)	MLU ST-08 R-R IC-F	MLU ST-08 R-L IC-F		
22-0100712-00		T2–T6	MLU ST-07 R-R IC-F	MLU ST-07 R-L IC-F		
		T1 (cut off)	MLU ST-08 R-R IC-F	MLU ST-08 R-L IC-F		
SR-20 J Type C	DE062010	12 × 12	T1–T6	MLU ST-07 R-R IC-F	MLU ST-07 R-L IC-F	
SR-20 RII	541-01	12 × 12	T1–T6	MLU ST-07 R-R IC-F	MLU ST-07 R-L IC-F	
SR-20 RIII	680-62	12 × 12	T2–T6	MLU ST-07 R-R IC-F	MLU ST-07 R-L IC-F	
SR-20 RIV	0W0-62	12 × 12	T2–T5, T11–T12	MLU ST-07 R-R IC-F	MLU ST-07 R-L IC-F	
			T1 (cut off)	MLU ST-09 R-R IC-F	MLU ST-09 R-L IC-F	
	22-0101068-00		T2–T5, T11–T12	MLU ST-07 R-R IC-F	MLU ST-07 R-L IC-F	
			T1 (cut off)	MLU ST-09 R-R IC-F	MLU ST-09 R-L IC-F	

Continuation

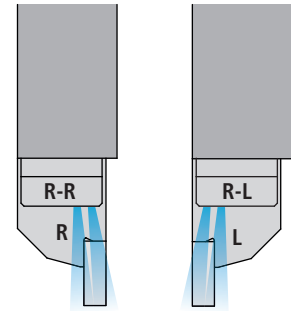

MLU ST... IC F (STAR)

R-R: Clamping shim for right-hand holders "R"; R-L: Clamping shim for left-hand holders "L"

Type of machine	Tool plate	Holder	Positions	Order designation		
				R	L	606
SV-20	22-0100181-01	12 × 12	T3–T5	MLU ST-10 R-R IC-F	MLU ST-10 R-L IC-F	
			T1–T2 (cut off)	MLU ST-11 R-R IC-F	MLU ST-11 R-L IC-F	
		½" (12.7)	T3–T5	MLU ST-10 R-R IC-F	MLU ST-10 R-L IC-F	
			T1–T2 (cut off)	MLU ST-11 R-R IC-F	MLU ST-11 R-L IC-F	
	24-0002928-03	12 × 12	T3–T5	MLU ST-10 R-R IC-F	MLU ST-10 R-L IC-F	
			T1–T2 (cut off)	MLU ST-11 R-R IC-F	MLU ST-11 R-L IC-F	
		½" (12.7)	T3–T5	MLU ST-10 R-R IC-F	MLU ST-10 R-L IC-F	
			T1–T2 (cut off)	MLU ST-11 R-R IC-F	MLU ST-11 R-L IC-F	
	421-01	12 × 12	T3–T5	MLU ST-10 R-R IC-F	MLU ST-10 R-L IC-F	
			T1–T2 (cut off)	MLU ST-11 R-R IC-F	MLU ST-11 R-L IC-F	
		½" (12.7)	T3–T5	MLU ST-10 R-R IC-F	MLU ST-10 R-L IC-F	
			T1–T2 (cut off)	MLU ST-11 R-R IC-F	MLU ST-11 R-L IC-F	
SV-20 R	T100	12 × 12	T1–T7	MLU ST-15 R-R IC-F	MLU ST-15 R-L IC-F	
SW-20	571-01	12 × 12	T11–T12	MLU ST-07 R-R IC-F	MLU ST-07 R-L IC-F	
	571-03		T2–T4	MLU ST-07 R-R IC-F	MLU ST-07 R-L IC-F	
			T1 (cut off)	MLU ST-07 R-R IC-F	MLU ST-07 R-L IC-F	
SR-32 J	670-62	⅝" (15.875)	T2–T6	MLU ST-03 R-R IC-F	MLU ST-03 R-L IC-F	
			T1 cut off)	MLU ST-02 R-R IC-F	MLU ST-02 R-L IC-F	
			T2–T6	MLU ST-03 R-R IC-F	MLU ST-03 R-L IC-F	
		16 × 16	T1 cut off)	MLU ST-02 R-R IC-F	MLU ST-02 R-L IC-F	
			T2–T4	MLU ST-13 R-R IC-F	MLU ST-13 R-L IC-F	
SV32	421-04	16 × 16	T1 (cut off)	MLU ST-12 R-R IC-F	MLU ST-12 R-L IC-F	

Scope of delivery: Clamping shim with stop

- Coolant system 619...
- Torque screwdriver 651...

Attention

Tighten the multidec®-LUB clamping shim using the torque screwdriver according to the marking on the shim.

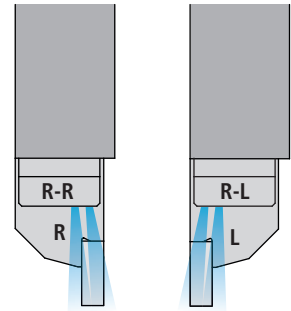
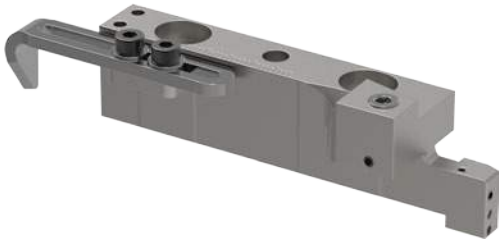

MLU TO-... IC F (TORNOS)

R-R: Clamping shim for right-hand holders "R"; R-L: Clamping shim for left-hand holders "L"

Type of machine	Tool plate	Holder	Positions	Order designation		606
				R	L	
DT13	390223	12 × 12	T2–T5	MLU TO-06 R-R IC-F	■ MLU TO-06 R-L IC-F	■
	390224		T1 (cut off)	MLU TO-06 R-R IC-F	■ MLU TO-06 R-L IC-F	■
GT13	390223	12 × 12	T2–T5	MLU TO-06 R-R IC-F	■ MLU TO-06 R-L IC-F	■
	390224		T1 (cut off)	MLU TO-06 R-R IC-F	■ MLU TO-06 R-L IC-F	■
CT20/5	2000118	12 × 12	T1–T6	MLU TO-05 R-R IC-F	■ MLU TO-05 R-L IC-F	■
Swiss GT26	386209	16 × 16	T1–T5	MLU TO-04 R-R IC-F	■ MLU TO-04 R-L IC-F	■
	386210		T2–T4	MLU TO-03 R-R IC-F	■ MLU TO-03 R-L IC-F	■
Swiss ST26	398577	12 × 12	T1 (cut off)	MLU TO-02 R-R IC-F	■ MLU TO-02 R-L IC-F	■
			T2–T5	MLU TO-09 R-R IC-F	■ MLU TO-09 R-L IC-F	■
			T1	MLU TO-08 R-R IC-F	■ MLU TO-08 R-L IC-F	■
			T1–T3	MLU TO-08 R-R IC-F	■ MLU TO-08 R-L IC-F	■
Swiss GT32	398585	16 × 16	T1–T2	MLU TO-08 R-R IC-F	■ MLU TO-08 R-L IC-F	■
	398595			MLU TO-08 R-R IC-F	■ MLU TO-08 R-L IC-F	■
			T110–T114	MLU TO-04 R-R IC-F	■ MLU TO-04 R-L IC-F	■

Scope of delivery: Clamping shim with stop

Coolant system 619...
 Torque screwdriver 651...

Attention
 Tighten the multidec®-LUB clamping shim using the torque screwdriver according to the marking on the shim.

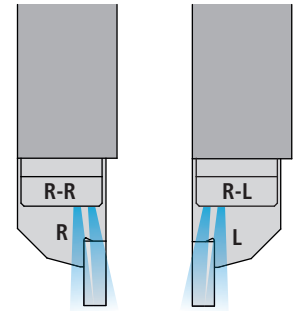

MLU TS-... IC F (TSUGAMI)

R-R: Clamping shim for right-hand holders "R"; **R-L:** Clamping shim for left-hand holders "L"







Type of machine	Tool plate	Holder	Positions	Order designation			
				R	L	606	
BH20		12 × 12	T2–T4	MLU TS-02 R-R IC-F	■	MLU TS-02 R-L IC-F	■
			T1 (cut off)	MLU TS-04 R-R IC-F	■	MLU TS-04 R-L IC-F	■
BH20 Z		12 × 12	T2–T4	MLU TS-02 R-R IC-F	■	MLU TS-02 R-L IC-F	■
			T1 (cut off)	MLU TS-04 R-R IC-F	■	MLU TS-04 R-L IC-F	■
BS20 S-V	Plate 1	12 × 12	T4–T5	MLU TS-02 R-R IC-F	■	MLU TS-02 R-L IC-F	■
	Plate 2		T11–T16	MLU TS-02 R-R IC-F	■	MLU TS-02 R-L IC-F	■
BO123 E	Plate 1	12 × 12	T1–T6	MLU TS-02 R-R IC-F	■	MLU TS-02 R-L IC-F	■
BO124 E	Plate 1	12 × 12	T1–T6	MLU TS-02 R-R IC-F	■	MLU TS-02 R-L IC-F	■
BO125 E	Plate 1	12 × 12	T1–T6	MLU TS-02 R-R IC-F	■	MLU TS-02 R-L IC-F	■
BO126 E II	Plate 1	12 × 12	T1–T6	MLU TS-02 R-R IC-F	■	MLU TS-02 R-L IC-F	■
BO203	Plate 1	12 × 12	T1–T6	MLU TS-02 R-R IC-F	■	MLU TS-02 R-L IC-F	■
BO204 E	Plate 1	12 × 12	T1–T6	MLU TS-02 R-R IC-F	■	MLU TS-02 R-L IC-F	■
BO205 E	Plate 1	12 × 12	T1–T6	MLU TS-02 R-R IC-F	■	MLU TS-02 R-L IC-F	■
S205	Plate 1	12 × 12	T4–T8	MLU TS-02 R-R IC-F	■	MLU TS-02 R-L IC-F	■
	Plate 2		T18–T20	MLU TS-02 R-R IC-F	■	MLU TS-02 R-L IC-F	■
S206	Plate 1	12 × 12	T4–T8	MLU TS-02 R-R IC-F	■	MLU TS-02 R-L IC-F	■
	Plate 2		T18–T20	MLU TS-02 R-R IC-F	■	MLU TS-02 R-L IC-F	■
S206E		12 × 12		MLU TS-02 R-R IC-F	■	MLU TS-02 R-L IC-F	■
HS207	Plate 1	12 × 12	T4–T8	MLU TS-01 R-R IC-F	■	MLU TS-01 R-L IC-F	■
SS207	Plate 1	12 × 12	T4–T8	MLU TS-01 R-R IC-F	■	MLU TS-01 R-L IC-F	■
	Plate 2		T18–T20	MLU TS-01 R-R IC-F	■	MLU TS-01 R-L IC-F	■
		½" (12.7)	T4–T8	MLU TS-11 R-R IC-F	■	MLU TS-11 R-L IC-F	■
SS207-5AX	Plate 1	12 × 12	T4–T8	MLU TS-01 R-R IC-F	■	MLU TS-01 R-L IC-F	■
	Plate 2		T18–T20	MLU TS-01 R-R IC-F	■	MLU TS-01 R-L IC-F	■
HS267		16 × 16		MLU TS-02 R-R IC-F	■	MLU TS-02 R-L IC-F	■
HS327		16 × 16	T1–T5	MLU TS-06 R-R IC-F	■	MLU TS-06 R-L IC-F	■

Scope of delivery: Clamping shim with stop

Coolant system 619...
 Torque screwdriver 651...

Attention

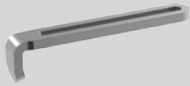
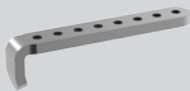
Tighten the multidec®-LUB clamping shim using the torque screwdriver according to the marking on the shim.

Illustration	Description	Dimensions	Order designation	
	Pointer		MLU 68-01	■
	Allen head screw	M3 x 6 DIN912	MSP30060 IB2.5	■
	Washer	M3/3.2/7/0.5	MSP US-3	■
	Screw plug	M5 x 4	MSP VSR M5	■
	Stop	L 27	MLU-27-06 AN-A	■
		L 42	MLU 42 AN-A	■
		L 47	MLU-47-06 AN-A	■
		L 50	MLU 50 AN-A	■
		L 60	MLU 60 AN-A	■
	Stop	L 54	MLU 54 AN-I	■
	Hold-down spring	L27	MLU-NF	■

In order to determine the correct multidec®-LUB clamping shim, we require the exact dimensions of the tool plate and clamping shim. Therefore, please send these to us as a sample for measurement or use the form to send us the required information.

Attention

The positions in the tool plate are not always identical. Therefore, measure the position where you want to use the multidec®-LUB clamping shim exactly.

Machine data	
Manufacturer	
Type	
Year of manufacture	
Serial number	
Plate number	
Shaft cross-section	

Dimensions (mm)	
X1	
X2*	
X3	
X4	

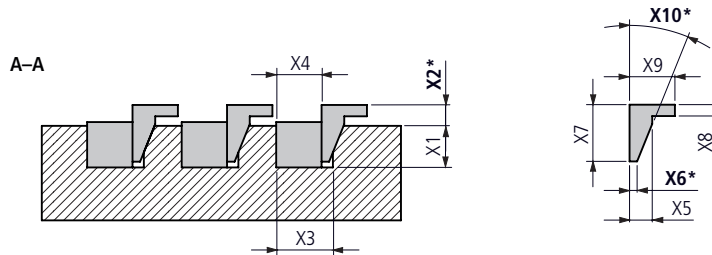

Dimensions (mm)	
X5	
X6*	
X7	
X8	
X9	
X10*	

* Important dimension: Enter exact measurement!

Dimensions (mm)	
X11	
X12	
X13	
X14*	
X15	

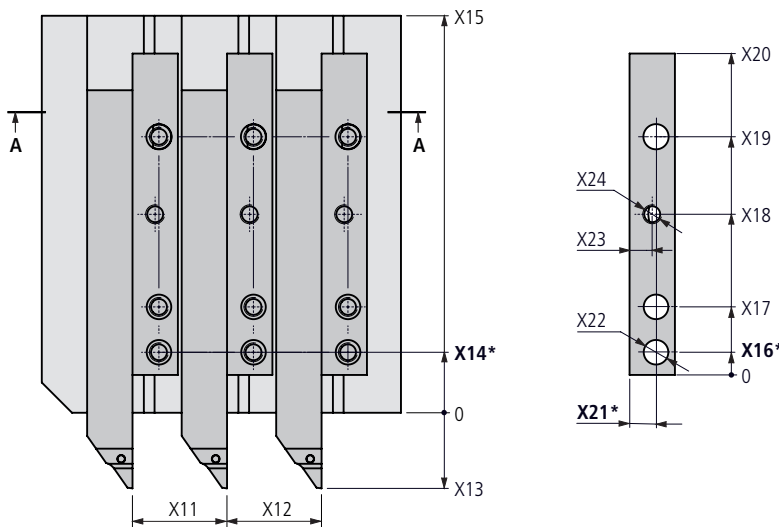

Dimensions (mm)	
X16*	
X17	
X18	
X19	
X20	
X21*	
X22	
X23	
X24	

Company _____

Responsible person _____

Road _____

Postal code, City _____

Phone _____

Fax _____

E-mail _____



■ Utilis AG, Precision Tools
 Kreuzlingerstrasse 22, CH-8555 Müllheim, Switzerland
 Phone +41 52 762 62 62, Fax +41 52 762 62 00
 info@utilis.com, www.utilis.com

The newly developed high-pressure solution from UTILIS (up to a maximum of 200 bar or 2900 psi) ensures optimal delivery of coolant to the insert.

The highly compact and robust design and the stainless steel finish are the main features of this product.

The product range includes several straight and pivoting unions with connection diameters of 4 mm and several quick connections. The use thereof dispenses with the laborious task of unscrewing the high-pressure tubes. This increases efficiency by minimising machine downtime.

The high-pressure hoses are available in a wide variety of lengths with different connections.

Reduction unions, extensions, screw connections, spare parts and coolant distributors round off the product range.

Benefits:

- Flexible enough to be used with all multidec® product lines with internal cooling
- Can be used within a temperature range of –60 to +250 °C or –76 to +482 °F
- Can be used up to a maximum operating pressure of 200 bar or 2900 psi



The range associated with the low-pressure solution for operating pressures up to a maximum of 30 bar or 435 psi includes a straight union and a swivel-type union with a connecting diameter of 4 mm when a polyurethane tube is being used.

As with our high-pressure solution, we offer reduction unions, extensions, closing plugs, and sealing rings. The polyurethane tube with an external diameter of 4 mm is 1000 mm long. This allows you to cut it to the length you need on a case-by-case basis.









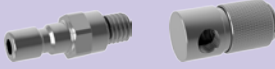
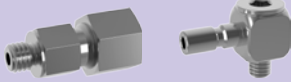
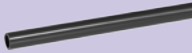

A well-balanced range of compact coolant distributors made of light metal completes the offer.

Benefits:

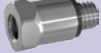
- Flexible enough to be used with all multidec® product lines with internal cooling
- Can be used up to a maximum operating pressure of 30 bar or 435 psi (test pressure of 30 bar or 435 psi)
- Corrosion-resistant and compact design



Overview – Coolant system

Connecting options		620
Coolant distributors – high / low pressure		623
Tubes – high pressure		624
Quick change connectors – high pressure		626
Unions – high pressure		630
Coolant tubes – low pressure		632
Unions – low pressure		633
Screw connections – high / low pressure		634
Extensions – high / low pressure		635
Reduction unions – high / low pressure		636
Closing plug – high pressure		637
Closing plug – low pressure		638
Replacement parts – high / low pressure		639
Nozzle / socket installation		640
STVR / EWR installation		641

High pressure



MLU KV ...

623



MLU... IC ...

608...



... IC

81...

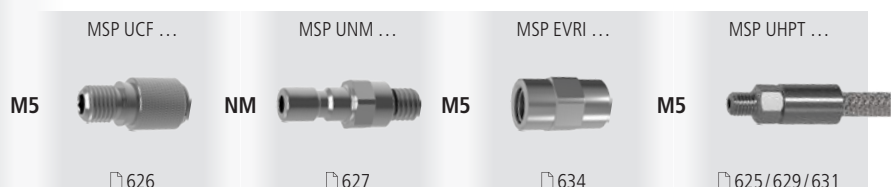
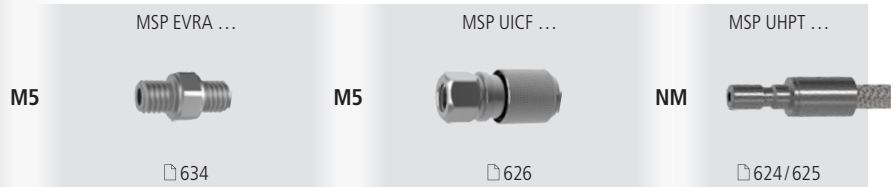

Low pressure



High pressure

MSP UHPT ...



NM

▣ 624/625

MSP UACF ...

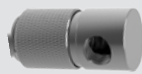

M5

▣ 626

MSP EVRA ...



M5

▣ 634

MSP UHPT ...



4

▣ 628/629

MSP USVR ...

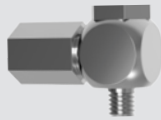

M5

▣ 630

... IC



▣ 81...

MSP UHPT ...



M5

▣ 625/629/631

MSP RVRW ...

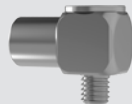

M5

▣ 634

MLU... IC ...



▣ 608...

MSP UHPT ...



M5

▣ 625/629/631

MSP UICF ...

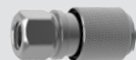

NM

▣ 626

MSP USNM ...

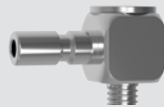

M5

▣ 627

MSP UHPT ...



M5

▣ 625/629/631

MSP UANM ...



NM

▣ 627

MSP UCF ...

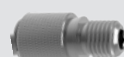

M5

▣ 626

MLU KV ...



▣ 623

MSP UHPT ...



M5

▣ 625/629/631

MSP UACF ...

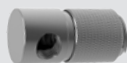

NM

▣ 626

MSP UNM ...



M5

▣ 627

Low pressure

MSP KSK...



4KS

▣ 632

MSP EWR ...



M5

▣ 633

maximum 200 bar/2900 psi

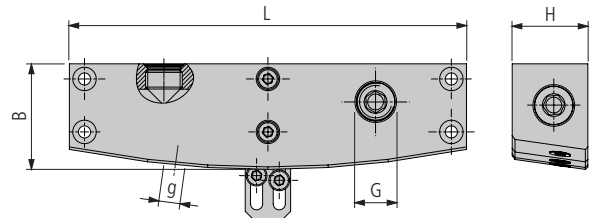

MLU KV ... L (Large)

Order designation		Inputs G	Outputs g	Dimensions			Connecting options		620/621
				B	L	H	M5	G½**	
MLU KV 2-3 L	■	3 × G½	2 × M5	25	35	20	Miscellaneous	MSP ... G1/8	
MLU KV 4-3 L	■	3 × G½	4 × M5	27	68	20			
MLU KV 6-3 L	■	3 × G½	6 × M5	28	105	20			
MLU KV 8-3 L	■	3 × G½	8 × M5	28	138	20			

MLU KV ... S* (Small)

Order designation		Inputs G	Outputs g	Dimensions			Connecting options		620/621
				B	L	H	M5	G½**	
MLU KV 2-3 S	■	3 × G½	2 × M5	25	23	20	Miscellaneous	MSP ... G1/8	
MLU KV 4-3 S	■	3 × G½	4 × M5	27	45	20			
MLU KV 6-3 S	■	3 × G½	6 × M5	28	65	20			
MLU KV 8-3 S	■	3 × G½	8 × M5	28	85	20			

* Quick couplings can only be used to a limited extent (less space in this version)

** Screw plugs 637
Replacement parts 639

maximum 200 bar/2900 psi

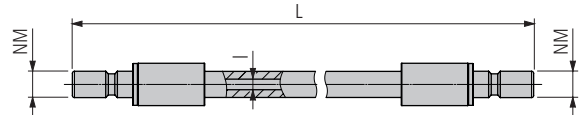

MSP UHPT ... NM-NM (Plug – Plug)

Order designation	Dimensions					Connecting options
	L	I				NM
MSP UHPT 100 NM-NM	100	3				MSP UICF ... MSP UCF ... MSP UACF ...
MSP UHPT 150 NM-NM	150	3				
MSP UHPT 200 NM-NM	200	3				
MSP UHPT 250 NM-NM	250	3				
MSP UHPT 300 NM-NM	300	3				
MSP UHPT 400 NM-NM	400	3				
MSP UHPT 500 NM-NM	500	3				

No sealing ring required

MSP UHPTB* ... NM-NM (Plug – Plug)

Order designation	Dimensions					Connecting options
	L	I				NM
MSP UHPTB 100 NM-NM	100	3.7				MSP UICF ... MSP UCF ... MSP UACF ...
MSP UHPTB 150 NM-NM	150	3.7				
MSP UHPTB 200 NM-NM	200	3.7				
MSP UHPTB 250 NM-NM	250	3.7				
MSP UHPTB 300 NM-NM	300	3.7				
MSP UHPTB 400 NM-NM	400	3.7				
MSP UHPTB 500 NM-NM	500	3.7				

No sealing ring required

* B (bigger): for 50 % more coolant passage

maximum 200 bar/2900 psi

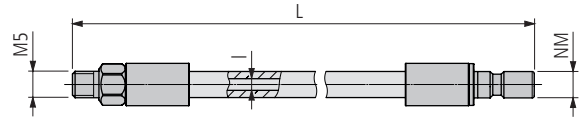

MSP UHPT ... M5-NM (External thread –Pug)

Order designation		Dimensions				Connecting options 620/621	
		L	I			M5	NM
MSP UHPT 100 M5-NM	■	100	3			Miscellaneous	MSP UICF ... MSP UCF ... MSP UACF ...
MSP UHPT 150 M5-NM	■	150	3				
MSP UHPT 200 M5-NM	■	200	3				
MSP UHPT 250 M5-NM	■	250	3				
MSP UHPT 300 M5-NM	■	300	3				
MSP UHPT 400 M5-NM	■	400	3				
MSP UHPT 500 M5-NM	■	500	3				

No sealing ring required

MSP UHPTB* ... M5-NM (External thread –Pug)

Order designation		Dimensions				Connecting options 620/621	
		L	I			M5	NM
MSP UHPTB 100 M5-NM	■	100	3.7			Miscellaneous	MSP UICF ... MSP UCF ... MSP UACF ...
MSP UHPTB 150 M5-NM	■	150	3.7				
MSP UHPTB 200 M5-NM	■	200	3.7				
MSP UHPTB 250 M5-NM	■	250	3.7				
MSP UHPTB 300 M5-NM	■	300	3.7				
MSP UHPTB 400 M5-NM	■	400	3.7				
MSP UHPTB 500 M5-NM	■	500	3.7				

No sealing ring required

* B (bigger): for 50 % more coolant passage

maximum 200 bar/2900 psi

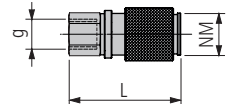
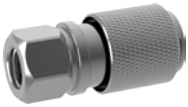

MSP UICF ... (Internal thread–Coupling)

Order designation		Dimensions				Connecting options	
		g	L			g	NM
MSP UICF M5	■	M5	18			Miscellaneous	MSP ...UNM MSP ...USNM MSP ...UANM

No sealing ring required

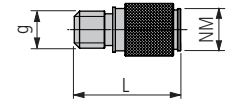

MSP UCF ... (External thread–Coupling)

Order designation		Dimensions				Connecting options	
		g	L			g	NM
MSP UCF M5	■	M5	21			Miscellaneous	MSP ...UNM MSP ...USNM MSP ...UANM
MSP UCF M6	■	M6	21				
MSP UCF M8	■	M8	19				
MSP UCF M8x1	■	M8 x 1	19				
MSP UCF G1/8	■	G ¹ / ₈	19				
MSP UCF PT1/8	■	PT ¹ / ₈	20				

No sealing ring required

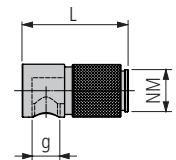
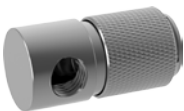

MSP UACF ... (Internal thread 90°–Coupling)

Order designation		Dimensions				Connecting options	
		g	L			g	NM
MSP UACF M5	■	M5	20			Miscellaneous	MSP ...UNM MSP ...USNM MSP ...UANM

No sealing ring required

Closing plug □ 637
 Replacement parts □ 639

Legend □ 8...

maximum 200 bar/2900 psi

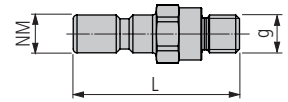

MSP UNM ... (Plug–External thread)

Order designation		Dimensions				Connecting options	
		g	L			g	NM
MSP UNM M5	■	M5	19.5				
MSP UNM M6	■	M6	19.5				
MSP UNM M8	■	M8	21.5				
MSP UNM M8x1	■	M8 × 1	19.5			Miscellaneous	MSP ...UICF ... MSP ...UCF ... MSP ...UACF ...
MSP UNM G1/8	■	G1/8	22				
MSP UNM PT1/8	■	PT1/8	20				
MSP UNM UNF5/16	■	UNF5/16	19.5				

No sealing ring required

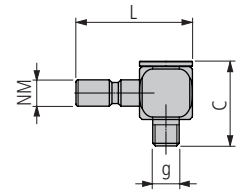

MSP USNM ... (90° plug–External thread, swivelling)

Order designation		Dimensions				Connecting options	
		g	C	L		g	NM
MSP USNM M5	■	M5	16	22			
MSP USNM M6	■	M6	17	22			
MSP USNM M8	■	M8	17.5	24			
MSP USNM M8x1	■	M8 × 1	17.5	24		Miscellaneous	MSP ...UICF ... MSP ...UCF ... MSP ...UACF ...
MSP USNM G1/8	■	G1/8	20	28			

No sealing ring required

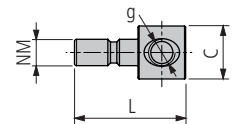

MSP UANM ... (Plug, internal thread 90°)

Order designation		Dimensions				Connecting options	
		g	C	L		g	NM
MSP UANM M5	■	M5	10	21		Miscellaneous	MSP ...UICF ... MSP ...UCF ... MSP ...UACF ...

No sealing ring required

maximum 200 bar/2900 psi

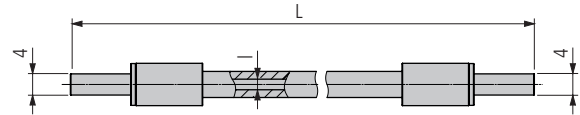

MSP UHPT ... 4-4 (Nozzle–Nozzle)

Order designation	Dimensions					Connecting options
	L	I				620/621
MSP UHPT 100 4-4	100	3				4 MSP UGVR ... MSP USVR ...
MSP UHPT 150 4-4	150	3				
MSP UHPT 200 4-4	200	3				
MSP UHPT 250 4-4	250	3				
MSP UHPT 300 4-4	300	3				
MSP UHPT 400 4-4	400	3				
MSP UHPT 500 4-4	500	3				

No sealing ring required

MSP UHPTB* ... 4-4 (Nozzle–Nozzle)

Order designation	Dimensions					Connecting options
	L	I				620/621
MSP UHPTB 100 4-4	100	3.7				4 MSP UGVR ... MSP USVR ...
MSP UHPTB 150 4-4	150	3.7				
MSP UHPTB 200 4-4	200	3.7				
MSP UHPTB 250 4-4	250	3.7				
MSP UHPTB 300 4-4	300	3.7				
MSP UHPTB 400 4-4	400	3.7				
MSP UHPTB 500 4-4	500	3.7				

No sealing ring required

* B (bigger): for 50 % more coolant passage

Nozzle/socket installation 640

maximum 200 bar/2900 psi

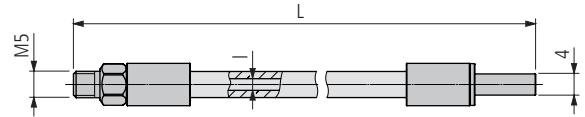

MSP UHPT ... M5-4 (External thread – Nozzle)

Order designation	Dimensions					Connecting options 620/621	
	L	I				M5	4
MSP UHPT 100 M5-4	■	100	3			Miscellaneous	MSP UGVR ... MSP USVR ...
MSP UHPT 150 M5-4	■	150	3				
MSP UHPT 200 M5-4	■	200	3				
MSP UHPT 250 M5-4	■	250	3				
MSP UHPT 300 M5-4	■	300	3				
MSP UHPT 400 M5-4	■	400	3				
MSP UHPT 500 M5-4	■	500	3				

No sealing ring required

MSP UHPTB* ... M5-4 (External thread – Nozzle)

Order designation	Dimensions					Connecting options 620/621	
	L	I				M5	4
MSP UHPTB 100 M5-4	■	100	3.7			Miscellaneous	MSP UGVR ... MSP USVR ...
MSP UHPTB 150 M5-4	■	150	3.7				
MSP UHPTB 200 M5-4	■	200	3.7				
MSP UHPTB 250 M5-4	■	250	3.7				
MSP UHPTB 300 M5-4	■	300	3.7				
MSP UHPTB 400 M5-4	■	400	3.7				
MSP UHPTB 500 M5-4	■	500	3.7				

No sealing ring required

* B (bigger): for 50 % more coolant passage

Nozzle/socket installation 640

maximum 200 bar/2900 psi

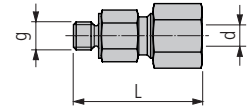
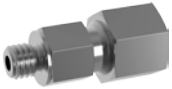

MSP UGVR ... (External thread–External thread)

Order designation		Dimensions				Connecting options	
		g	d	L		g	4
MSP UGVR M5-4	■	M5	4	27			620/621
MSP UGVR G1/8-4	■	G1/8	4	32		Miscellaneous	MSP UHPT ...-4
MSP UGVR PT1/8-4	■	PT1/8	4	32			

No sealing ring required

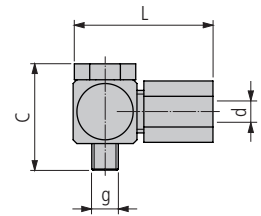
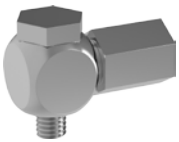

MSP USVR ... (External thread 90°, swivelling–Socket)

Order designation		Dimensions				Connecting options	
		g	d	L	C	g	4
MSP USVR M5-4	■	M5	4	28	21		620/621
MSP USVR G1/8-4	■	G1/8	4	37	30	Miscellaneous	MSP UHPT ...-4

No sealing ring required

- Replacement parts 639
- Nozzle/socket installation 640

maximum 200 bar/2900 psi

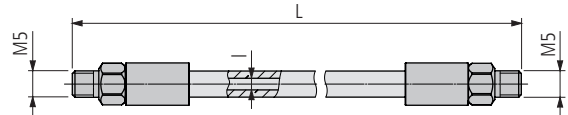

MSP UHPT ... M5-M5 (External thread – External thread)

Order designation	Dimensions					Connecting options
	L	I				M5
MSP UHPT 100 M5-M5	■	100	3.7			Miscellaneous
MSP UHPT 150 M5-M5	■	150	3.7			
MSP UHPT 200 M5-M5	■	200	3.7			
MSP UHPT 250 M5-M5	■	250	3.7			
MSP UHPT 300 M5-M5	■	300	3.7			
MSP UHPT 400 M5-M5	■	400	3.7			
MSP UHPT 500 M5-M5	■	500	3.7			

No sealing ring required

MSP UHPTB* ... M5-M5 (External thread – External thread)

Order designation	Dimensions					Connecting options
	L	I				M5
MSP UHPTB 100 M5-M5	■	100	3.7			Miscellaneous
MSP UHPTB 150 M5-M5	■	150	3.7			
MSP UHPTB 200 M5-M5	■	200	3.7			
MSP UHPTB 250 M5-M5	■	250	3.7			
MSP UHPTB 300 M5-M5	■	300	3.7			
MSP UHPTB 400 M5-M5	■	400	3.7			
MSP UHPTB 500 M5-M5	■	500	3.7			

No sealing ring required

* B (bigger): for 50 % more coolant passage

maximum 30 bar/435 psi

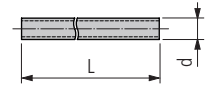

MSP KSK... (4KS – 4KS)

Order designation		Dimensions				Connecting options 620/621
		d	L			4KS
MSP KSK-4KS	■	4	1000			MSP STVR ... MSP EWR ...

maximum 30 bar/435 psi

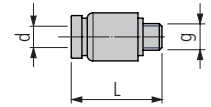

MSP STVR ... (KS4–External thread)

Order designation	Dimensions				Connecting options 620/621	
	d	g	L		KS4	M5
MSP STVR KS4-M5	4	M5	17		MSP KSK...	Miscellaneous

Including sealing ring

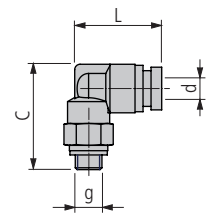

MSP EWR ... (External thread 90° – KS4)

Order designation	Dimensions				Connecting options 620/621	
	g	d	L	C	M5	KS4
MSP EWR M5-KS4	M5	4	18	21	Miscellaneous	MSP KSK...

Including sealing ring

- Closing plug MSP VSK ... 638
- Replacement parts 639
- STVR/EWR installation 641

maximum 200 bar/2900 psi

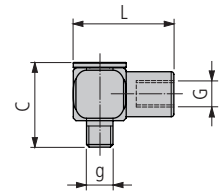

MSP RVRW ... (External thread 90°, swivelling – Internal thread)

Order designation	Dimensions				
	g	G	L	C	
MSP RVRW M5-M5	M5	M5	19	16	

No sealing ring required

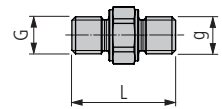

MSP EVRA ... (External thread – External thread)

Order designation	Dimensions			
	G	g	L	
MSP EVRA M5-M5	M5	M5	14	

No sealing ring required

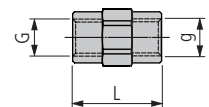
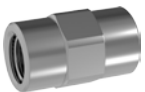

MSP EVRI ... (Internal thread – Internal thread)

Order designation	Dimensions			
	G	g	L	
MSP EVRI M5-M5	M5	M5	14	

No sealing ring required

maximum 200 bar/2900 psi

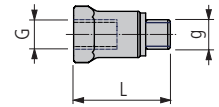

MSP VLR ... (Internal thread – External thread)

Order designation		Dimensions				
		G	g	L		
MSP VLR 100 M5-M5	■	M5	M5	10		
MSP VLR 200 M5-M5	■	M5	M5	20		
MSP VLR 400 M5-M5	■	M5	M5	40		

Including sealing ring

Replacement parts 639

maximum 200 bar/2900 psi

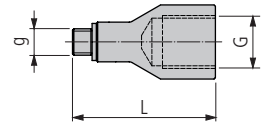

MSP RVRI ... (External thread–Internal thread)

Order designation		Dimensions			
		g	G	L	
MSP RVRI 100 M5-M6	■	M5	M6	15	
MSP RVRI 185 M5-M8x1	■	M5	M8x1	23	
MSP RVRI 225 M5-M10x1	■	M5	M10x1	27	
MSP RVRI 225 M5-G1/8	■	M5	G1/8	27	

Including sealing ring

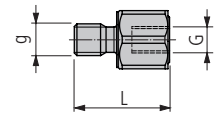

MSP RVRA ... (External thread–Internal thread)

Order designation		Dimensions			
		g	G	L	
MSP RVRA 100 M6-M5	■	M6	M5	18	
MSP RVRA 70 M8x1-M5	■	M8x1	M5	15	
MSP RVRA 70 M10x1-M5	■	M10x1	M5	15	
MSP RVRA 70 G1/8-M5	■	G1/8	M5	15	

No sealing ring required

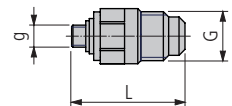

MSP RVR ... (External thread–External thread)

Order designation		Dimensions			
		g	G	L	
MSP RVR M5-7/16-20 UNF	■	M5	7/16-20 UNF	29	

Including sealing ring

Replacement parts □ 639

Legend □ 8...

maximum 200 bar/2900 psi

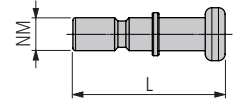
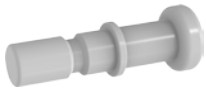

MSP VNM (Plug)

Order designation		Dimensions				NM
		L				
MSP VNM	■	23				MSP ...UICF ... MSP ...UCF ... MSP ...UACF ...



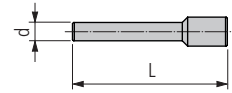

No sealing ring required

maximum 30 bar/435 psi



MSP VSK... (4KS)

Order designation		Dimensions				d
		d	L			
MSP VSK-4KS	■	4	32			MSP STVR ... MSP EWR ...

Illustration	Description	Dimensions	Order designation	related to
	Sealing ring	5	MSP USK-M5	■ MSP STVR... ■ MSP EWR... ■ MSP VLR... ■ MSP RVRI... ■ MSP RVR...
	Nut for clamping ring	4	MSP UCN 4	■ MSP UGVR M5-4 ■ MSP USVR M5-4
			MSP UCN 6	■ MSP UGVR G1/8-4 ■ MSP USVR G1/8-4
			MSP UCN PT1/8	■ MSP UGVR PT1/8
	Clamping ring for tube connection	4	MSP UCR 4	■ MSP UGVR M5-4 ■ MSP USVR M5-4
			MSP UCR 6-4	■ MSP UGVR G1/8-4 ■ MSP USVR G1/8-4
			MSP UCR PT1/8	■ MSP UGVR PT1/8
	Screw plug	M5	MSP VSR M5 IB2.5	■ MLU KV...
		M6x0.5	MSP VSR M6x0.5 IB3	■ MLU KV...
		M8x1	MSP VSR M8x1 IB4	■ MLU KV...
		G7/8	MSP VSR G1/8 IB5	■ MLU KV...

Initial assembly

1. Screw on the union nut by hand until finger-tight. At the same time, push the tube against the fitting.
2. Tighten down the union nut through **1 3/4 rotations** using an open-end wrench.
 - 1 Making a mark will assist in correct rotation. Hold the adaptor with a second wrench to prevent it turning.

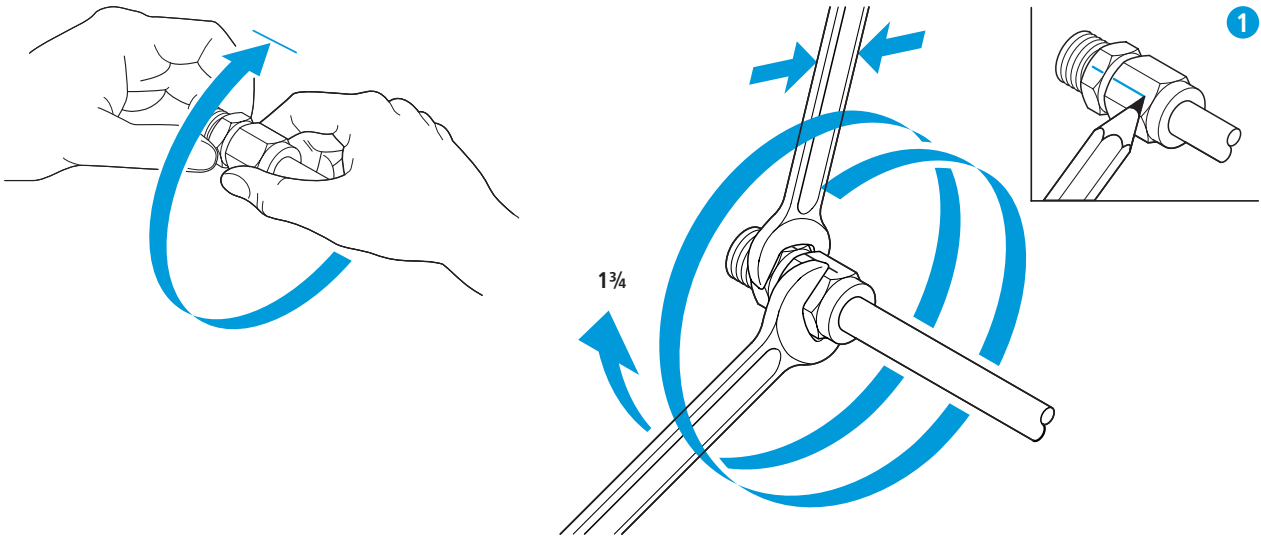
**Repeat assembly**

When refitting the same tube union, screw the union nut back on by hand until finger-tight and tighten down the union nut with an open-end wrench with **1/4 of a rotation** for the final fit.

In the event of repeat fitting, parts must be lubricated.

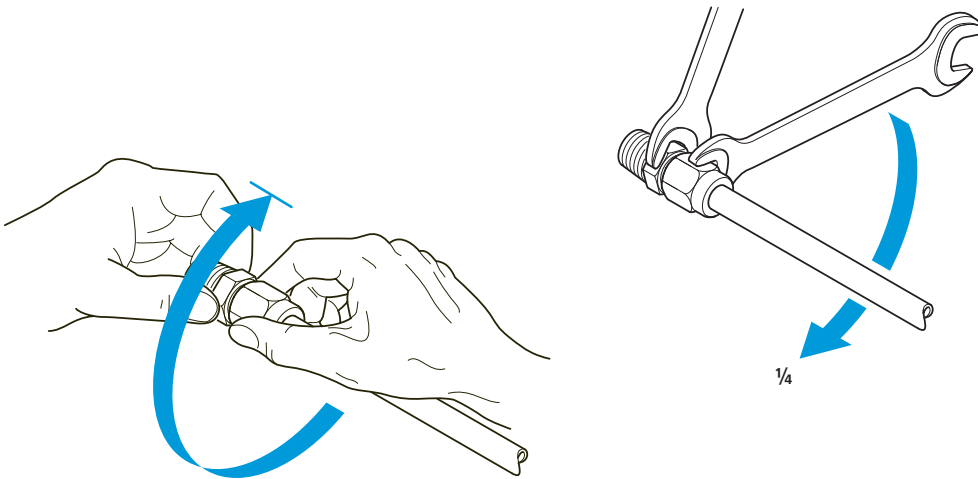

Installation of the straight plug connector

1. Screw on the straight plug connector by hand until finger-tight.
2. With the Allen key, thoroughly tighten the straight plug connector (as shown) through the opening for the connection using the force of your fingers only.

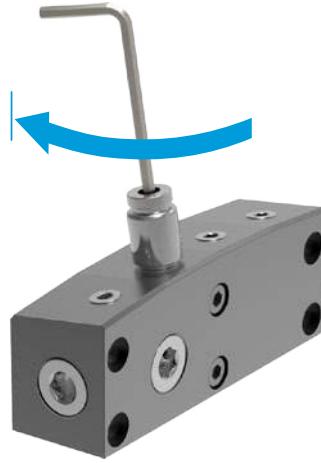
**Installation of the swivel-type plug connector**

1. Screw on the swivel plug connector by hand until finger-tight.
2. With an open-end wrench, thoroughly tighten the swivel-type plug connector (as shown) using a normal amount of force.

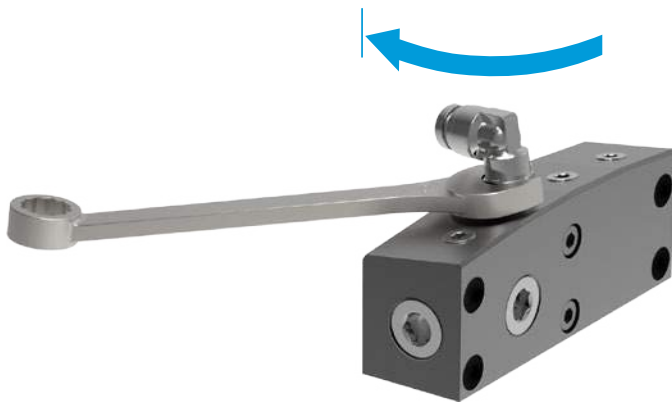

multidec®-TAPER-IN is a tool holder serie that has been specially developed to be used on Swiss type turning machines. These tool holders have a monoblock design in order to achieve the highest possible stability. The multidec®-TAPER-IN tool holders can be used in any driven or stationary spindle compliant with the DIN 6499 standard.

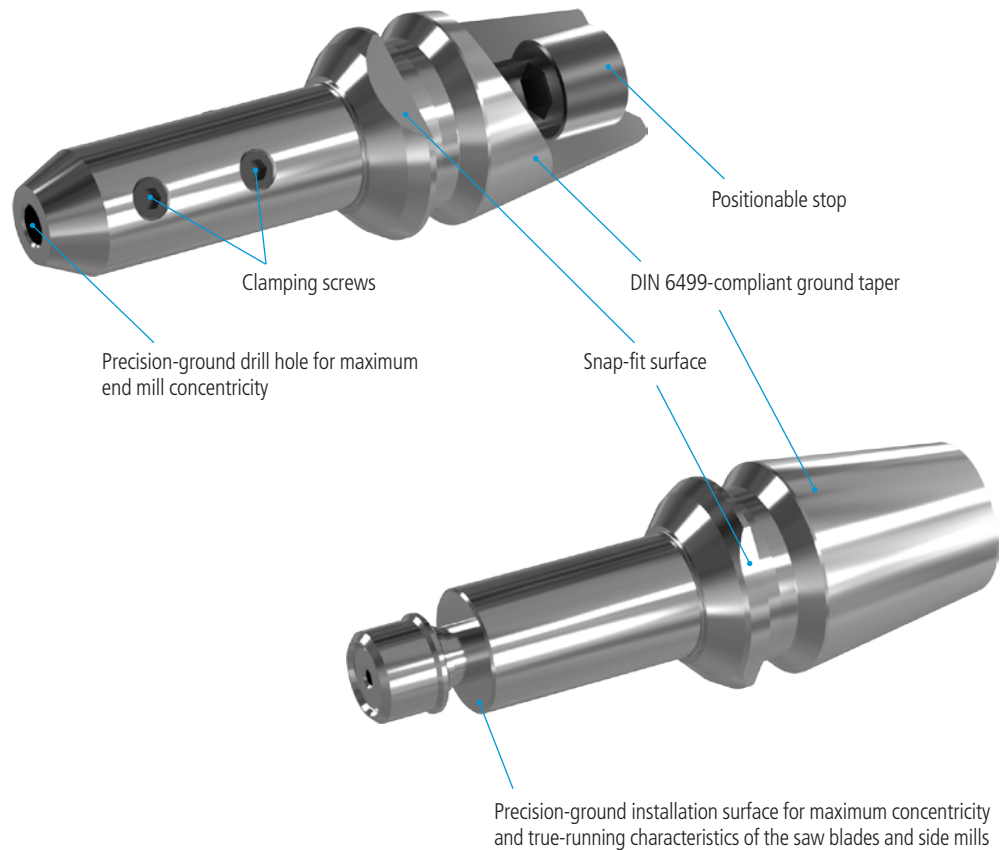

Benefits:

- Ideally suited to Swiss-type turning machines (profile turning)
- Direct fit in the collet chuck with ER cone
- No special clamping nuts are needed
- Monoblock design for reduced added tolerance
- High stability
- Ground surfaces
- Holder for ER sizes 8, 11, 16, 20 and 25
- Concentric accuracy of 0.005 mm
- Stop screw adjustable on both sides for tool positioning

Overview – multidec®-TAPER-IN

Technical information 11

Monoblock ER tool holder (for end mills)



644

Monoblock ER tool holder (for saw blades and side mills)

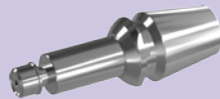

646

Replacement and spare parts



648

For end mills

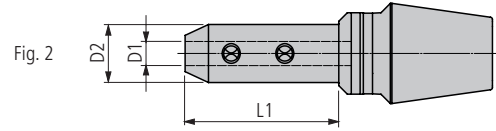
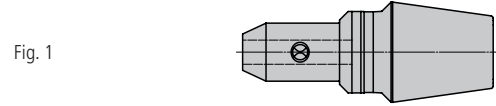

MTIM ER ...

Order designation		Dimensions					Fig.
		ER	D1	L1	D2		
MTIM ER8-1.00-10	■	8	1	10	6.4		1
MTIM ER8-1.00-15	■	8	1	15	6.4		1
MTIM ER8-1.50-10	■	8	1.5	10	6.4		1
MTIM ER8-1.50-15	■	8	1.5	15	6.4		1
MTIM ER8-1.59-10	■	8	1.59	10	6.4		1
MTIM ER8-1.59-15	■	8	1.59	15	6.4		1
MTIM ER8-2.00-10	■	8	2	10	6.4		1
MTIM ER8-2.00-15	■	8	2	15	6.4		1
MTIM ER8-3.00-10	■	8	3	10	7		1
MTIM ER8-3.00-15	■	8	3	15	7		1
MTIM ER8-3.18-10	■	8	3.18	10	7		1
MTIM ER8-3.18-15	■	8	3.18	15	7		1
MTIM ER11-1.59-10	■	11	1.59	10	6.4		1
MTIM ER11-2.00-10	■	11	2	10	6.4		1
MTIM ER11-3.00-10	■	11	3	10	8		1
MTIM ER11-3.00-15	■	11	3	15	8		1
MTIM ER11-3.00-20	■	11	3	20	8		2
MTIM ER11-3.18-10	■	11	3.18	10	8		1
MTIM ER11-3.18-15	■	11	3.18	15	8		1
MTIM ER11-3.18-20	■	11	3.18	20	8		2
MTIM ER11-4.00-15	■	11	4	15	8		1
MTIM ER11-4.00-20	■	11	4	20	8		2
MTIM ER16-1.00-16	■	16	1	16	6.4		1
MTIM ER16-1.50-16	■	16	1.5	16	6.4		1
MTIM ER16-1.59-16	■	16	1.59	16	6.4		1
MTIM ER16-2.00-16	■	16	2	16	6.4		1
MTIM ER16-1.00-16	■	16	1	16	6.4		1
MTIM ER16-1.50-16	■	16	1.5	16	6.4		1
MTIM ER16-1.59-16	■	16	1.59	16	6.4		1
MTIM ER16-2.00-16	■	16	2	16	6.4		1
MTIM ER16-3.00-16	■	16	3	16	9.5		1
MTIM ER16-3.00-25	■	16	3	25	9.5		2
MTIM ER16-3.18-16	■	16	3.18	16	9.5		1
MTIM ER16-3.18-25	■	16	3.18	25	9.5		2
MTIM ER16-4.00-16	■	16	4	16	9.5		1
MTIM ER16-4.00-25	■	16	4	25	9.5		2
MTIM ER16-4.76-16	■	16	4.76	16	9.5		1
MTIM ER16-4.76-25	■	16	4.76	25	9.5		2
MTIM ER16-5.00-16	■	16	5	16	9.5		1
MTIM ER16-5.00-25	■	16	5	25	9.5		2
MTIM ER20-3.00-25	■	20	3	25	9.5		2
MTIM ER20-3.18-16	■	20	3.18	16	9.5		1
MTIM ER20-3.18-25	■	20	3.18	25	9.5		2
MTIM ER20-4.00-14	■	20	4	14	9.5		1
MTIM ER20-4.00-16	■	20	4	16	9.5		1

Continuation

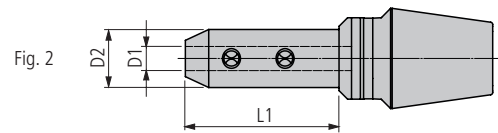
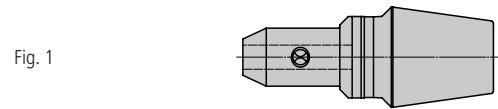

MTIM ER ...

Order designation		Dimensions						Fig.
		ER	D1	L1	D2			
MTIM ER20-4.00-25	■	20	4	25	9.5			2
MTIM-ER20-4.76-14	■	20	4.76	14	11.4			1
MTIM ER20-4.76-25	■	20	4.76	25	11.4			2
MTIM ER20-5.00-14	■	20	5	14	11.4			1
MTIM ER20-5.00-25	■	20	5	25	11.4			2
MTIM ER20-6.00-14	■	20	6	14	12.5			1
MTIM ER20-6.00-25	■	20	6	25	12.5			2
MTIM ER20-6.35-14	■	20	6.35	14	12.5			1
MTIM ER20-6.35-25	■	20	6.35	25	12.5			2
MTIM ER25-3.00-25	■	25	3	25	10			2
MTIM ER25-3.18-25	■	25	3.18	25	10			2
MTIM ER25-4.00-25	■	25	4	25	10			2
MTIM ER25-4.76-25	■	25	4.76	25	12.5			2
MTIM ER25-5.00-25	■	25	5	25	12.5			2
MTIM ER25-6.00-25	■	25	6	25	12.5			2
MTIM ER25-6.35-25	■	25	6.35	25	12.5			2
MTIM ER25-7.00-25	■	25	7	25	16			2
MTIM ER25-7.94-25	■	25	7.94	25	16			2
MTIM ER25-8.00-25	■	25	8	25	16			2

For saw blades and side mills

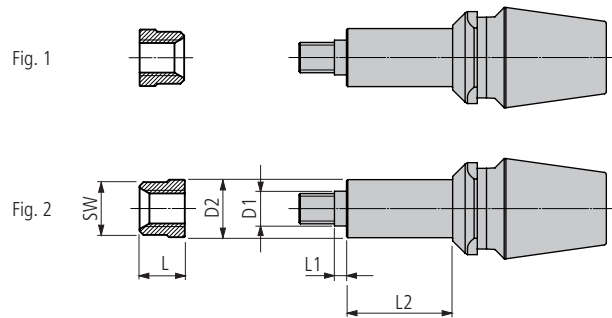

MTIS ER ...

Order designation		Dimensions							Saw blade thickness	
		ER	D1	D2	L1	L2	L	SW	Fig. 1	Fig. 2
MTIS ER11-3.00-10	■	11	3	6.35	1.27	10	5	5	0.13-2	1.2-3
MTIS ER11-3.00-14	■	11	3	6.35	1.27	14	5	5	0.13-2	1.2-3
MTIS ER11-3.00-19	■	11	3	6.35	1.27	19	5	5	0.13-2	1.2-3
MTIS ER11-3.00-25	■	11	3	6.35	1.27	25	5	5	0.13-2	1.2-3
MTIS ER11-3.18-10	■	11	3.18	6.35	1.27	10	5	5	0.13-2	1.2-3
MTIS ER11-3.18-14	■	11	3.18	6.35	1.27	14	5	5	0.13-2	1.2-3
MTIS ER11-3.18-19	■	11	3.18	6.35	1.27	19	5	5	0.13-2	1.2-3
MTIS ER11-3.18-25	■	11	3.18	6.35	1.27	25	5	5	0.13-2	1.2-3
MTIS ER11-4.76-10	■	11	4.76	8	1.27	10	5	7	0.13-2	1.2-3
MTIS ER11-4.76-14	■	11	4.76	8	1.27	14	5	7	0.13-2	1.2-3
MTIS ER11-4.76-19	■	11	4.76	8	1.27	19	5	7	0.13-2	1.2-3
MTIS ER11-4.76-25	■	11	4.76	8	1.27	25	5	7	0.13-2	1.2-3
MTIS ER11-5.00-10	■	11	5	8	1.27	10	5	7	0.13-2	1.2-3
MTIS ER11-5.00-14	■	11	5	8	1.27	14	5	7	0.13-2	1.2-3
MTIS ER11-5.00-19	■	11	5	8	1.27	19	5	7	0.13-2	1.2-3
MTIS ER11-5.00-25	■	11	5	8	1.27	25	5	7	0.13-2	1.2-3
MTIS ER11-6.00-10	■	11	6	8	1.27	10	6.35	7	0.13-2	1.2-3
MTIS ER11-6.00-14	■	11	6	8	1.27	14	6.35	7	0.13-2	1.2-3
MTIS ER11-6.00-19	■	11	6	8	1.27	19	6.35	7	0.13-2	1.2-3
MTIS ER11-6.00-25	■	11	6	8	1.27	25	6.35	7	0.13-2	1.2-3
MTIS ER16-3.00-18	■	16	3	6.35	1.27	18	6.35	5	0.13-2.5	1.2-3
MTIS ER16-3.00-24	■	16	3	6.35	1.27	24	6.35	5	0.13-2.5	1.2-3
MTIS ER16-3.18-18	■	16	3.18	6.35	1.27	18	6.35	5	0.13-2.5	1.2-3
MTIS ER16-3.18-24	■	16	3.18	6.35	1.27	24	6.35	5	0.13-2.5	1.2-4
MTIS ER16-4.76-18	■	16	4.76	9.53	1.27	18	6.35	8	0.13-2.5	1.2-4
MTIS ER16-4.76-24	■	16	4.76	9.53	1.27	24	6.35	8	0.13-2.5	1.2-4
MTIS ER16-5.00-18	■	16	5	9.53	1.27	18	6.35	8	0.13-2.5	1.2-4
MTIS ER16-5.00-24	■	16	5	9.53	1.27	24	6.35	8	0.13-2.5	1.2-4
MTIS ER16-6.00-18	■	16	6	9.53	1.27	18	6.35	8	0.13-2	1.2-4
MTIS ER16-6.00-24	■	16	6	9.53	1.27	24	6.35	8	0.13-2	1.2-4
MTIS ER16-6.35-18	■	16	6.35	9.53	1.27	18	6.35	8	0.13-2.5	1.2-4
MTIS ER16-6.35-24	■	16	6.35	9.53	1.27	24	6.35	8	0.13-2.5	1.2-4
MTIS ER16-7.94-18	■	16	7.94	10	1.27	18	6.35	9	0.13-2.5	1.2-4
MTIS ER16-7.94-24	■	16	7.94	10	1.27	24	6.35	9	0.13-2.5	1.2-4
MTIS ER16-8.00-18	■	16	8	10	1.27	18	6.35	9	0.13-2.5	1.2-4
MTIS ER16-8.00-24	■	16	8	10	1.27	24	6.35	9	0.13-2.5	1.2-4
MTIS ER20-3.00-18	■	20	3	6.35	1.27	18	6.35	5	0.13-3	1.2-3
MTIS ER20-3.00-30	■	20	3	6.35	1.27	30	6.35	5	0.13-3	1.2-3
MTIS ER20-3.18-18	■	20	3.18	6.35	1.27	18	6.35	5	0.13-3	1.2-3
MTIS ER20-3.18-30	■	20	3.18	6.35	1.27	30	6.35	5	0.13-3	1.2-3
MTIS ER20-4.76-18	■	20	4.76	9.53	1.27	18	6.35	8	0.13-3	1.2-4
MTIS ER20-4.76-30	■	20	4.76	9.53	1.27	30	6.35	8	0.13-3	1.2-4
MTIS ER20-5.00-18	■	20	5	9.53	1.27	18	6.35	8	0.13-3	1.2-4
MTIS ER20-5.00-30	■	20	5	9.53	1.27	30	6.35	8	0.13-3	1.2-4
MTIS ER20-6.00-18	■	20	6	9.53	1.27	18	6.35	8	0.13-3	1.2-4

Continuation

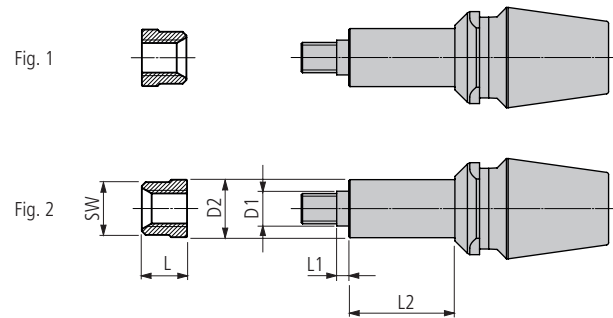



MTIS ER ...

Order designation		Dimensions							Saw blade thickness	
		ER	D1	D2	L1	L2	L	SW	Fig. 1	Fig. 2
MTIS ER20-6.00-30	■	20	6	9.53	1.27	30	6.35	8	0.13-3	1.2-4
MTIS ER20-6.35-18	■	20	6.35	9.53	1.27	18	6.35	8	0.13-3	1.2-4
MTIS ER20-6.35-30	■	20	6.35	9.53	1.27	30	6.35	8	0.13-3	1.2-4
MTIS ER20-7.94-18	■	20	7.94	10	1.27	18	6.35	9	0.13-3	1.2-4
MTIS ER20-7.94-30	■	20	7.94	10	1.27	30	6.35	9	0.13-3	1.2-4
MTIS ER20-8.00-18	■	20	8	10	1.27	18	6.35	9	0.13-3	1.2-4
MTIS ER20-8.00-30	■	20	8	10	1.27	30	6.35	9	0.13-3	1.2-4
MTIS ER20-9.52-18	■	20	9.52	12.5	1.27	18	7	11	0.13-3	1.2-4
MTIS ER20-9.52-30	■	20	9.52	12.5	1.27	30	7	11	0.13-3	1.2-4
MTIS ER20-10.0-18	■	20	10	12.5	1.27	18	7	11	0.13-4	1.2-6
MTIS ER20-10.0-30	■	20	10	12.5	1.27	30	7	11	0.13-4	1.2-6

Including clamping nuts

For tool clamp

Illustration	Description	Dimensions	Order designation		Tool holder
	Clamping screw	M2 × 2	MSP 20020 IB0.9	■	MTIM ER8...
		M3 × 3	MSP 30030 IB1.5	■	MTIM ER11... / MTIM ER16... / MTIM ER20-3.00–5.00 / MTIM ER25-3.00–5.00
		M4 × 4	MSP 40040 IB2	■	MTIM ER20-6.00–6.35 / MTIM ER 25-6.00–8.00
	Allen key	SW 0.9	MSP IB0.9	■	MTIM ER8...

For positionable stop

Illustration	Description	Dimensions	Order designation		Tool holder
	Headless screw with hexagon socket (double-sided)	M4 × 4	MSP 40040 IB2	■	MTIM ER8...
		M6 × 5	MSP 60050 AN IB3-2.5	■	MTIM ER11...
		M8 × 6	MSP 80060 AN IB4-2.5	■	MTIM ER16... / MTIM ER20...
		M10 × 21	MSP 100210 AN IB5-2.5	■	MTIM ER25...

For side mill holder

Illustration	Description	Dimensions	Order designation		Tool holder
	Clamping nut	M3 × 0.5	MSP TI 03.00 ER11	■	MTIS ER11-3.00... / MTIS ER11-3.18...
		M3 × 0.5	MSP TI 03.00 ER16-ER20	■	MTIS ER16-3.00... / MTIS ER16-3.18... / MTIS ER20-3.00... / MTIS ER20-3.18...
		10-32 UNF	MSP TI 04.76 ER16-ER20	■	MTIS ER16-4.76... / MTIS ER20-4.76...
		10-32 UNF	MSP TI 05.00 ER11	■	MTIS ER11-4.76... / MTIS ER11-5.00...
		M5 × 0.8	MSP TI 05.00 ER16-ER20	■	MTIS ER16-5.00... / MTIS ER20-5.00...
		M6 × 1	MSP TI 06.00 ER11	■	MTIS ER11-6.00...
		M6 × 1	MSP TI 06.00 ER16-ER20	■	MTIS ER16-6.00... / MTIS ER20-6.00...
		1/4-32 UNF	MSP TI 06.35 ER16-ER20	■	MTIS ER16-6.35... / MTIS ER20-6.35...
		5/16-32 UNF	MSP TI 08.00 ER16-ER20	■	MTIS ER16-7.94... / MTIS ER16-8.00... / MTIS ER20-7.94... / MTIS ER20-8.00...
3/8-32 UNF	MSP TI 10.00 ER20	■	MTIS ER20-9.52... / MTIS ER20-10.00...		

For spindle-connection

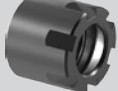
Illustration	Description	Dimensions	Order designation		Tool holder
	Clamping nut	M10 × 0.75	Hi-Q/ERM 8	■	ER8
		M13 × 0.75	Hi-Q/ERM 11	■	ER11
		M19 × 1	Hi-Q/ERM 16	■	ER16
		M24 × 1	Hi-Q/ERM 20	■	ER20
		M30 × 1	Hi-Q/ERM 25	■	ER25

Screwdriver

Maximum possible hardness combined with high toughness are essential for any high quality tool. Use of a special alloy gives our blades exceptional toughness and elasticity even at a hardness of 58 to 60 HRC.

The special surface structure of the handle gives a firm grip even with wet and oily hands. Safe working and a long tool life are guaranteed with this screwdriver.



Overview – Screwdriver

Technical information

11

Torque screwdriver



652

Replaceable blades



652

TORX screwdriver



653



MSP TX... / GHEX... D*

Order designation		Dimensions				Handle
		TORX	TORX PLUS	Allen head	Torque (Nm)	
MSP TX06 D	■	T06			0.6	A
MSP TX07 D	■	T07			0.9	A
MSP TX08 D	■	T08			1.2	A
MSP TX09 D	■	T09			1.4	A
MSP TX10 D	■	T10			2	A
MSP TX15 D	■	T15			3	A
MSP TX20 D	■	T20			3	A
MSP TXP06 D	■		TP06		0.6	A
MSP TXP07 D	■		TP07		0.9	A
MSP TXP08 D	■		TP08		1.2	A
MSP TXP09 D	■		TP09		1.4	A
MSP TXP10 D	■		TP10		2	A
MSP TXP15 D	■		TP15		3	A
MSP TXP20 D	■		TP20		3	A
MSP GHEX 2.9 D	■			M4	2.9	A
MSP GHEX 6.0 D	■			M5	6	B
MSP GHEX 10.0 D	■			M6	10	B

MSP KTX... / KHEX... D

Order designation		Screw
MSP KTX06 D	■	M... T 06
MSP KTX07 D	■	M... T 07
MSP KTX08 D	■	M... T 08
MSP KTX09 D	■	M... T 09
MSP KTX10 D	■	M... T 10
MSP KTX15 D	■	M... T 15
MSP KTX20 D	■	M... T 20
MSP KTXP06 D	■	M... TP 06
MSP KTXP07 D	■	M... TP 07
MSP KTXP08 D	■	M... TP 08
MSP KTXP09 D	■	M... TP 09
MSP KTXP10 D	■	M... TP 10
MSP KTXP15 D	■	M... TP 15
MSP KTXP20 D	■	M... TP 20
MSP KHEX IB3 D	■	M4
MSP KHEX IB4 D	■	M5
MSP KHEX IB5 D	■	M6

* Preset with replaceable blade (TORX and TORX PLUS can be used with the same handle)



MSP TX...

Order designation		Dimensions				Screw
		TORX	TORX PLUS	Allen head	Torque (Nm)	
MSP TX05	■	T05				M... T 05
MSP TX06	■	T06				M... T 06
MSP TX07	■	T07				M... T 07
MSP TX08	■	T08				M... T 08
MSP TX09	■	T09				M... T 09
MSP TX10	■	T10				M... T 10
MSP TX15	■	T15				M... T 15
MSP TX20	■	T20				M... T 20
MSP TXP06	■		TP06			M... TP 06
MSP TXP07	■		TP07			M... TP 07
MSP TXP08	■		TP08			M... TP 08
MSP TXP09	■		TP09			M... TP 09
MSP TXP10	■		TP10			M... TP 10
MSP TXP15	■		TP15			M... TP 15
MSP TXP20	■		TP20			M... TP 20

These collets are made in-house by UTILIS and can be supplied from stock. They are manufactured for universal use with all screw-fitted milling cutters which have the same interface-specific application. To be used as ER adapters they offer several advantages, even by comparison with full carbide shank milling cutters.

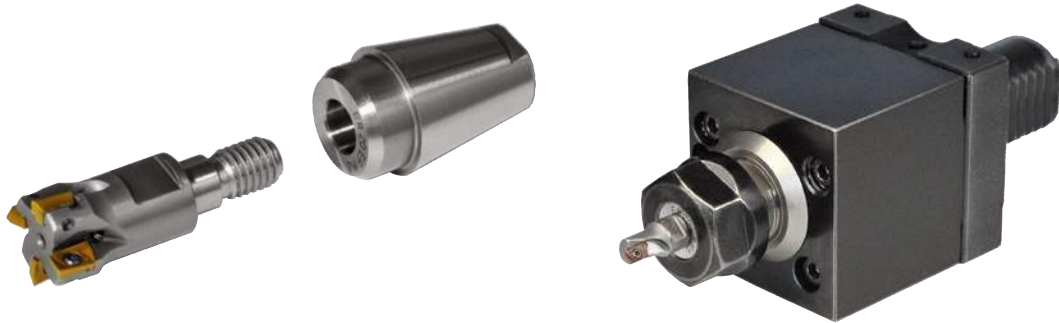

Special features and advantages:

- Short and stable tool clamping
- Suitable for use on both, Swiss type lathes and regular short turning lathes
- Fewer vibrations than carbide endmill (less wear/tool breakage)
- Lower tool costs
- Higher cutting parameters than carbide endmill
- Also suitable for low power machines
- Concentricity <0.005 mm

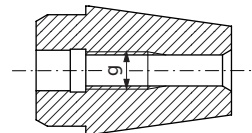

ER.. EF ..

Order designation		Dimensions					Collet type
		g					
ER16 EF M6	■	M6					ER16
ER16 EF M8	■	M8					ER16
ER16 EF M8-LH	■	M8-LH					ER16
ER16 EF M10	■	M10					ER16
ER20 EF M6	■	M6					ER20
ER20 EF M8	■	M8					ER20
ER20 EF M10	■	M10					ER20
ER20 EF M14-LH	■	M14-LH					ER20
ER25 EF M6	■	M6					ER25
ER25 EF M8	■	M8					ER25
ER25 EF M10	■	M10					ER25
ER32 EF M6	■	M6					ER32
ER32 EF M8	■	M8					ER32
ER32 EF M10	■	M10					ER32

The reduction sleeve gives the possibility fixing small tools in to the machine tool fixtures with bigger diameters. This small investment is an extremely flexible and economic solution giving an independent solution for different tool fixing situations.

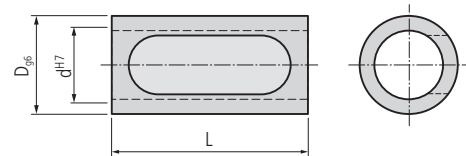

MRH ...

Order designation		Dimensions															
		D ₉₆	d ^{H7}	L													
MRH 15875 1230	■	15.875	12	30													
MRH 1600 1230	■	16	12	30													
MRH 1905 0840	■	19.05	8	40													
MRH 1905 1040	■	19.05	10	40													
MRH 1905 1240	■	19.05	12	40													
MRH 1905 1440	■	19.05	14	40													
MRH 1905 1640	■	19.05	16	40													
MRH 2000 1040	■	20	10	40													
MRH 2000 1240	■	20	12	40													
MRH 2000 1640	■	20	16	40													
MRH 2200 1240	■	22	12	40													
MRH 2200 1640	■	22	16	40													
MRH 2500 1240	■	25	12	40													
MRH 2500 1640	■	25	16	40													
MRH 2500 2040	■	25	20	40													
MRH 2540 1240	■	25.4	12	40													
MRH 2540 1640	■	25.4	16	40													
MRH 2540 2040	■	25.4	20	40													
MRH 3300 2040	■	33	20	40													
MRH 3300 2240	■	33	22	40													
MRH 3300 2540	■	33	25	40													

Concentricity < 0.01 mm

Index of designations

500...	47	1706... WCT	99	A... SDUC... (93°)	246
500... INCH	47	1710...	100	A... SVJP... (92°)	328
501...	46	1711...	101	A... SVOC... (95°)	299
1600...	80	3000...	150	A... SVQC... (107.5°)	298
1600... 00 RD	89	3000... A	154	A... SVUC... (93°)	300
1600... 00 RD INCH	89	3000... A IC	155		
1600...-4	82	3000... A IC INCH	155	C	
1600...-6	82	3000... A INCH	154	CCET	190
1600...-6-8 90 RD . IC	95	3000 AK... IC	158	CCGT	178–180, 182, 191–194
1600...-8	83	3000 AK... IC INCH	158	CCGT ... EN -PF23	184
1600... 45 ST A	91	3000... AV	152	CCGT ... FN -PF23	183
1600... 45 ST A INCH	91	3000... AV IC	153	CCMT	185–189
1600... 90	93	3000... AV IC INCH	153	CCXT	181
1600... 90 RD	94	3000... AV INCH	152		
1600... 90 ST	92	3000... C (Combi)	156	D	
1600... 90 ST A	90	3000... C (Combi) INCH	156	DCET	222
1600... 90 ST A INCH	90	3000... IC	151	DCET ... -PF05	212
1600/1600... TWIN	86	3000... IC INCH	151	DCGT	204–207, 223–225
1600/1600... TWIN IC	87	3000... IC-S	469	DCGT ... EN -A3	203
1600/1600... TWIN IC INCH	87	3000... IC-S INCH	469	DCGT ... EN -PF	210
1600/1600... TWIN INCH	86	3000... INCH	150	DCGT ... EN -PF23	214
1600... A	84	3001...	113	DCGT ... EN -PF33	216
1600... A INCH	84	3002...	114	DCGT ... FN -A3	202
1600... AV	85	3002... 16	118	DCGT ... FN -PF	209
1600... AV INCH	85	3002... 16 V	119	DCGT ... FN -PF23	213
1600... IC	81	3002... E. GS	130	DCGT ... FN -PF33	215
1600... IC INCH	81	3002... EN GS	132	DCGW	226
1600... IC-S	468	3002... E.V GS	131	DCMT	211, 217–221
1600... IC-S INCH	468	3002... F. GS	130	DCXT	208
1600... INCH	80	3002... FN GS	132	DECO... 7/10 CUT 1600	592
1600 YA... IC	88	3002... F.N GS12	129	DECO... 7/10 CUT 3000	592
1600 YA... IC INCH	88	3002... F.V GS	131	DECO... 7/10 SVJP ... (93°)	594
1601...	51, 444	3002... N SC	124	DECO... 7/10 SVJP ... V (93°)	594
1602...	52	3002... N SPT	128	DECO... 13/16 CUT 3000	593
1602... N SC	57	3002... SC	120	DECO... 13/16 SDJC ... (93°)	595
1602... N SPT	60	3002... SC TOP	122	DECO... 13/16 SVJP ... (93°)	596
1602... SC	55	3002... SPT	126	DECO... 13/16 SVJP ... V (93°)	596
1602... SC TOP	56	3002... TOP	116	DECO... 20/26/32 CUT 3000	593
1602... SPT	58	3002... V	115	DECO... 20/26/32 SVJP ... (93°)	597
1602... TOP	54	3002... V SC	121	DECO... 20/26/32 SVJP ... V (93°)	597
1602... V	53	3002... V SC TOP	123	DNGU ...	250
1602... V SC	55	3002... V SPT	127	DRL ...	378
1602... V SC TOP	56	3002... V TOP	117	DRP ...	376
1602... V SPT	59	3003...	133	DRS ...	377
1602... V TOP	54	3003... SP ...TOP	134		
1603...	61	3004... CP	139	E	
1603... CP TOP	63	3004... SP	136	ER.. EF ..	654
1603... SP U...	62	3004... SP TOP	138	ESCO ... CUT 1600	585
1604... SP	64	3004... TOP	137	ESCO D6...	584
1604... SP TOP	67	3004... TOP	137	ESCO ... DC ...	586
1604... TOP	66	3004... V CP	139	ESCO ... VB ...	588
1604... V SP	65	3004... V CP	139	ESCO ... VB ... N	588
1605...	68	3004... V SP	135	ESCO ... VC ...	587
1605... CP	69	3005...	140	ESCO ... VC ... N	587
1606...	73	3005... CP	141	ESCO ... VP ...	589
1606-G ...VP	72	3006...	146		
1606 HA... VP ...	74	3006-G ...VP	145	F	
1606 HB... VP ...	74	3006... UN ... VP	144	FGA ...	396
1606... UNC ...VP	71	3006... VP	142	FGB ...	396
1606... VP	70	3006... VP-S	143	FGQ ...	397
1607...	75	3007...	147	FGR ...	397
1610...	76	3012...	148		
1611...	77	3600...	164	H	
1611-45...	78	3600... IC	165	HSK... CUT 1600 ...	540
1612...	79	3600... IC INCH	165	HSK... CUT 1600-90 ...	541
1700...	104	3600... INCH	164	HSK... CUT 1600... RD	544
1700... 92 ST	105	3601...	162	HSK... CUT 3000 ...	540
1700... 92 ST A	106	3605... CP	163	HSK... CUT 3000-90 ...	541
1700... 92 ST A INCH	106			HSK-E40 MT CUT 500 ... WM	574
1700... 92 ST INCH	105	A			
1700... INCH	104	AKR M...	363		
1700... WCT	103	A... SCFC... (90°)	198		
1701...	98	A... SCLC... (95°)	199		
		A... SDOC... (95°)	242		
		A... SDQC... (107.5°)	243		

Index of designations

HSK-E40 MT CUT 1600 ... WM	574	MBG 14 ... (NEXTURN)	488	MSP VLR ...	635
HSK-E40 MT CUT 3000 ... WM	575	MBG 15 ... (HANWHA)	488	MSP VNM	637
HSK-E40 MT CUT 3600 ... WM	575	MBG 17 ... (TCM)	489	MSP VSK...	638
HSK-E40 MT SCLC... WM (95°)	577	MBG-T ... (STAR)	491	MTIM ER ...	644
HSK-E40 MT SDA . WM	580	MBK Cool Fix	514	MTIS ER ...	646
HSK-E40 MT SDJC... WM (93°)	578	MBK Cool Flex	514	multidec®-BACKTOOLS	474
HSK-E40 MT SVJC... WM (93°)	579	MBR ...	511	multidec®-BORE MICRO	334
HSK-E40 MT SVJP... V WM (93°)	576	MBS ...	506	multidec®-BROACH	368
HSK-E40 MT SVJP... WM (93°)	576	MBS ...-16 ER .A (VARGUS/ISCAR)	502	multidec®-CUT	32
HSK-... MT CUT 500 .	560	MBS ...-16 ER (VARGUS/ISCAR)	502	multidec®-CUT 500	44
HSK-... MT CUT 1600 .	560	MBS 090-CUT N 30 ...	505	multidec®-CUT 1600	48
HSK-... MT CUT 3000 .	561	MBS 180-CUT ...	504	multidec®-CUT 1700	96
HSK-... MT CUT 3600 .	561	MBS 180-CUT ... twin .	504	multidec®-CUT 3000	108
HSK-... MT SCLC... (95°)	563	MBS ...-CC	495	multidec®-CUT 3000-Laser «GS12»	109
HSK-... MT SDJC... (93°)	564	MBS ...-CC .A	495	multidec®-CUT 3600	160
HSK-... MT SVJC... (93°)	565	MBS ...-Cut ...	503	multidec®-DRILL	374
HSK-... MT SVJP... (93°)	562	MBS ...-Cut .A ...	503	multidec®-ESCOMATIC	582
HSK-... MT SVJP... V (93°)	562	MBS ...-DC	496	multidec®-GRAVER	394
HSK... SDA...	545	MBS ...-DC .A	496	multidec®-HSK	536
HSK-... SDA .	566	MBS E...	507	multidec®-ISO	172
HSK... SVJP ... (93°)	542	MBS ... IT...	510	multidec®-ISO-CC... (80°)	176
HSK... SVXP... (91°)	543	MBS SDA...	509	multidec®-ISO-DC... (55°)	200
HSK... VS	546	MBS ...-TC	500	multidec®-ISO-DN... (55°)	248
		MBS ...-TC .A	500	multidec®-ISO-VC... (35°)	258
		MBS TNMG ...	506	multidec®-ISO-VP... (35°)	304
		MBS V...	508	multidec®-KMTM	528
I		MBS ...-VC	497	multidec®-LUB	604
INNOVATION	7	MBS ...-VC .A	498	multidec®-MODULINE	516
		MBS ...-VP	499	multidec®-MULTITASK	558
		MBS ...-VP .A	499	multidec®-PSC	548
K		MBS ...-W0134	501	multidec®-SHORT	466
KM 12/16/20 CUT 1600 .	530	MBS ...-W0134 .A	501	multidec®-TAPER-IN	642
KM 12/16/20 SVXP... (91°)	532	MBZ ...	512	multidec®-THREADMILL	380
KM 12/16 CUT 1600-90 ...	531	MLU CI-... IC F (CITIZEN)	608, 609	multidec®-TORNOS DECO	590
KM 12/16 CUT 3000 ...	530	MLU DO-... IC F (DOOSAN)	610	multidec®-WHIRLING	398
KM 12/16 SVJP... (93°)	533	MLU GM-... IC F (GILDEMEISTER/DMG)	610	MWA...	407
KM 12 SDA...	534	MLU HA-... IC F (HANWHA)	611	MWA HSK...	441
KM 16 SDA...	534	MLU KV ... L (Large)	623	MWA PSC...	443
		MLU KV ... S (Small)	623	MWI... 1603...	451
		MLU MI-... IC F (MIYANO)	611	MWI... HA... VP	445
M		MLU ST-... IC F (STAR)	612, 613	MWI... HB... VP	445
MBA ...	513	MLU TO-... IC F (TORNOS)	614	MWI... HC... VP	446
MBD 02 ...	492	MLU TS-... IC F (TSUGAMI)	615	MWI... HD... VP	447
MBD 04 ... (STAR)	494	MRH ...	655	MWI... M... VP	448
MBD 11 ... (CITIZEN)	494	MSP	625	MWI... UNC VP	449
MBD ... E. (CITIZEN)	493	MSP EVRA ...	634	MWI... UNF VP	450
MBD ... E. (STAR)	493	MSP EVRI ...	634	MWR...	407
MBG 01 ... (HANWHA)	477	MSP EWR ...	633	MWT...	406
MBG 01 ... (STAR)	477	MSP KSK...	632	MWT... (ER)	439
MBG 02 ... B02 05 (CITIZEN)	490	MSP KTX.../KHES... D	652	MWT... HSK...	440
MBG 02 ... B02 05 (STAR)	490	MSP RVR ...	636	MWT... PSC...	442
MBG 02 ... (CITIZEN)	478	MSP RVRA ...	636	MWT... (TORNOS)	438
MBG 02 ... (GILDEMEISTER)	478	MSP RVRI ...	636	MWV...	454
MBG 02 ... (HAMWHA)	478	MSP RVRW ...	634		
MBG 02 ... (MANURHIN)	479	MSP STVR ...	633		
MBG 02 ... (STAR)	479	MSP TX...	653	P	
MBG 02 ... (TORNOS)	479	MSP TX.../GHEX... D	652	PSC 40 MT CUT 500 .	567
MBG 02 ... (TRAUB)	480	MSP UACF ...	626	PSC 40 MT CUT 1600 .	567
MBG 02 ... (TSUGAMI)	480	MSP UANM ...	627	PSC 40 MT CUT 3000 .	568
MBG 03 ... (CITIZEN)	481	MSP UCF ...	626	PSC 40 MT CUT 3600 .	568
MBG 03 ... (STAR)	481	MSP UGVR ...	630	PSC 40 MT SCLC... (95°)	570
MBG 04 ... IC (MAIER)	482	MSP UHPT ... 4-4	628	PSC 40 MT SDJC... (93°)	571
MBG 04 ... (STAR)	482	MSP UHPTB ... 4-4	628	PSC 40 MT SVJC... (93°)	572
MBG 05 ... (HANWHA)	483	MSP UHPTB ... M5-4	629	PSC 40 MT SVJP... (93°)	569
MBG 05 ... (STAR)	483	MSP UHPTB ... M5-M5	631	PSC 40 MT SVJP... V (93°)	569
MBG 06 ... (STAR)	483	MSP UHPTB ... NM-NM	624	PSC 40 SDA .	573
MBG 07 ... (STAR)	484	MSP UHPT ... M5-4	629	PSC ... CUT 1600 ...	550
MBG 08 ... (TORNOS)	484	MSP UHPT ... M5-M5	631	PSC ... CUT 1600-90 ...	551
MBG 09 ... (HANWHA)	485	MSP UHPT ... M5-NM	625	PSC ... CUT 1600... RD	554
MBG 09 ... (STAR)	485	MSP UHPT ... NM-NM	624	PSC ... CUT 3000 ...	550
MBG 09 ... (TSUGAMI)	485	MSP UICF ...	626	PSC ... CUT 3000-90 ...	551
MBG 10 ... (STAR)	486	MSP UNM ...	627	PSC ... SDA ...	555
MBG 11 ... (CITIZEN)	486	MSP USNM ...	627	PSC ... SVJP ... (93°)	553
MBG 12 ... (TSUGAMI)	487	MSP USVR ...	630	PSC ... SVXP... (91°)	552
MBG 13 ... (TORNOS)	487				

Index of designations

S

SCAC... U (90°)	195
SCDC... U (45°)	195
SCLC... U (95°)	196
SCLC... U (95°) INCH	196
SCLC... U IC (95°)	197
SCLC... U IC (95°) INCH	197
SD ...	338
SDA ...	360
SDAC... U (90°)	227
SDA ... SC	362
SD-BRH ...	371
SD-BRS ...	370
SD-BRT ...	372
SDG ...	339
SDH ...	345
SDHC... (107.5°)	240
SDHC... IC (107.5°)	241
SDHC... U (107.5°)	228, 229
SDHC... U (107.5°) INCH	228
SDHC... U IC (107.5°) INCH	229
SDI ...	341, 343, 344
SDJC. (93°)/1600... TWIN	238
SDJC. (93°)/1600... TWIN IC	239
SDJC. (93°)/1600... TWIN IC INCH	239
SDJC. (93°)/1600... TWIN INCH	238
SDJC... (93°) INCH	230
SDJC... U (93°)	230
SDJC... U FC (93°)	232
SDJC... U FC (93°) INCH	232
SDJC... U FC IC (93°)	233
SDJC... U FC IC (93°) INCH	233
SDJC... U IC (93°)	231, 245
SDJC... U IC (93°) INCH	231
SDJN... (93°)	252
SDJN... (93°) INCH	252
SDJN... IC (93°)	253
SDJN... IC (93°) INCH	253
SDK ...	346
SDM ...	347
SDNCN ...	236, 237
SDNC... U (62.5°)	234
SDNC... U (62.5°) INCH	234
SDNC... U IC (62.5°)	235
SDNC... U IC (62.5°) INCH	235
SDNNN ... (62.5°)	254
SDNNN ... (62.5°) INCH	254
SDNNN ... IC (62.5°)	255
SDNNN ... IC (62.5°) INCH	255
SDO ...	348
SDQ ...	349
SDR ...	351
SDS ...	352
SDT ...	353
SDU ...	354
SDUC... (93°)	244
SDV ...	355
SDW ...	350
SDY ...	356
SDZ ...	357
STARTER-SET	452
SVAC... U (90°)	283
SVAP... (90°)	311
SVAP... (90°) INCH	311
SVHC... U (107.5°)	286
SVHC... U (107.5°) INCH	286
SVHC... U IC (107.5°)	287
SVHC... U IC (107.5°) INCH	287
SVJC	472
SVJC. (93°)/1600... TWIN	296
SVJC. (93°)/1600... TWIN IC	297
SVJC. (93°)/1600... TWIN IC INCH	297
SVJC. (93°)/1600... TWIN INCH	296
SVJC... U (93°)	284
SVJC... U (93°) INCH	284
SVJC... U IC (93°)	285
SVJC... U IC (93°) INCH	285
SVJP	470, 471
SVJP... (92°)	327
SVJP... (93°)	312
SVJP. (93°)/1600... TWIN IC INCH (R-L)	325
SVJP. (93°)/1600... TWIN IC INCH (R-R)	323
SVJP. (93°)/1600... TWIN IC (R-L)	325
SVJP. (93°)/1600... TWIN IC (R-R)	323
SVJP. (93°)/1600... TWIN INCH (R-L)	324
SVJP. (93°)/1600... TWIN INCH (R-R)	322
SVJP. (93°)/1600... TWIN (R-L)	324
SVJP. (93°)/1600... TWIN (R-R)	322
SVJP... (93°) INCH	312
SVJP... FC (93°)	316
SVJP... FC (93°) INCH	316
SVJP... FC IC (93°)	317
SVJP... FC IC (93°) INCH	317
SVJP... IC (93°)	313
SVJP... IC (93°) INCH	313
SVJP... V (93°)	314
SVJP... V (93°) INCH	314
SVJP... V FC (93°)	318
SVJP... V FC (93°) INCH	318
SVJP... V FC IC (93°)	319
SVJP... V FC IC (93°) INCH	319
SVJP... V IC (93°)	315
SVJP... V IC (93°) INCH	315
SVJP. YA... IC (93°)	326
SVJP. YA... IC (93°) INCH	326
SVPC... U (117.5°)	288
SVPC... U (117.5°) INCH	288
SVPC... U IC (117.5°)	289
SVPC... U IC (117.5°) INCH	289
SVQC... (93°)	290
SVQP... (92°)	329
SVUC... (93°)	291
SVUP... (92°)	330
SVVCN	292, 293
SVXC... U (91°)	294, 295
SVXP... (91°)	320
SVXP... (91°) INCH	320
SVXP... IC (91°)	321
SVXP... IC (91°) INCH	321
SXG ...	340
SXI ...	342
SXJ ...	358
SXP ...	359

U

UMI ...	453
UML...	518
UML... 1600...	520
UML... 1600... A	520
UML... 3000...	521
UML... 3000... A	521
UML... SDJC... (93°)	522
UML... SVJC... (93°)	523
UML... SVJP... (93°)	525
UML... SVXC... (91°)	524
UML... SVXP... (91°)	526

V

VCET ... -PF05	268
VCGT ... 262, 263, 264, 266, 271, 278, 279, 280	
VCGT ... EN -A3	261
VCGT ... EN -PF23	270
VCGT ... EN -PF33	272
VCGT ... FN -A3	260
VCGT ... FN -PF23	269
VCGW	281
VCMT	267, 273, 274, 275, 276, 277
VCXT	265
VPET	307
VPGT	308
VPXT	309

W

WHA ...	384
WHB ...	385
WHC ...	386
WHC ... UNC ... (INCH)	387
WHC ... UNF ... (INCH)	387
WHD ...	388
WHD ... UNC ... (INCH)	389
WHD ... UNF ... (INCH)	389
WHL ...	383
WHS ...	382

Imprint

Liability / contents

Contents of the catalogue is provided with largest care. We can not guarantee for the correctness, completeness and topicality of contents.

Conception / design

UTILIS AG, Müllheim

Composition / realization

UTILIS AG, Müllheim

Photos / 3-D images

UTILIS AG, Müllheim

Print

Galledia AG, Flawil

Copyright

Each kind of the publication is inadmissible without permission of the UTILIS AG.

© Copyright 2020 – UTILIS AG

UTILIS[®]
Tooling for High Technology

■ **Utilis AG, Precision Tools**

Kreuzlingerstrasse 22, CH-8555 Müllheim, Switzerland
Phone +41 52 762 62 62, Fax +41 52 762 62 00
info@utilis.com, www.utilis.com