

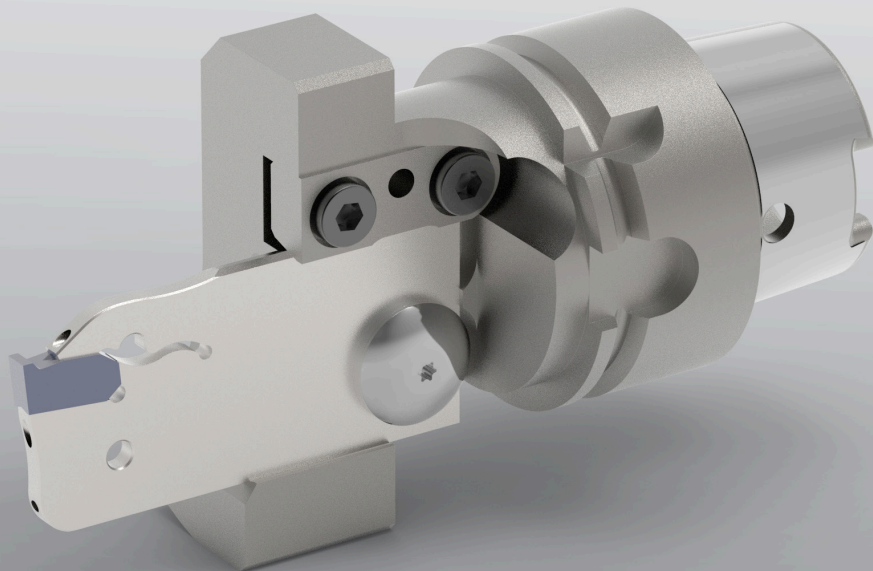

UTILIS
multidec[®]
swiss type tools

multidec[®]-4000

CUT OFF TOOL WITH INTEGRATED COOLING



INNOVATION

**DEVELOPED FOR CUTTING OFF LARGE DIAMETERS
ON MULTI-TASKING MACHINES**

future since **1915**

UTILIS[®]
Tooling for High Technology

With the new «multidec®-4000» product line, UTILIS is providing a powerful range of parting inserts which provides an optimum solution for parting operations for any material. These parting inserts can be used on the new series of multidec®-4000 holders, which are used for parting off up to a diameter of 65 mm.

The range of holders includes tools for turning operations on multi-tasking machines such as the turning-milling centres from Willemin-Macodel, Bumotec and Tsugami. With the HSK-A40, HSK-T40, HSK-E40 and PSC40 (Capto® C4) interfaces, the product range also includes a wide variety of connections.

All tools are equipped with ingenious internal cooling which accurately directs the coolant onto the cutting edge, which is extremely important when parting off large diameters and can increase the tool-life and process reliability of the tool considerably.

The parting inserts are easy to fit and replace using a provided installation wrench.

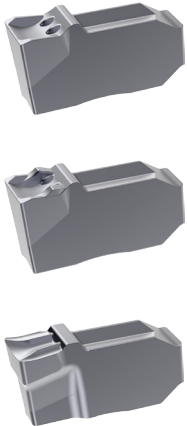
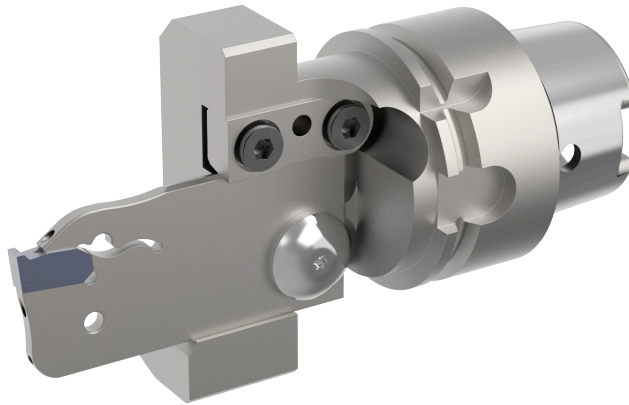

Advantages:

- Diameters up to 65 mm can be parted off
- Choice of parting inserts with several carbide grades and coatings
- Compact and solid design
- The insert is positioned on the center line (guaranteeing a very accurate cutting edge height and high repeatability while also reducing of the load on the spindle)
- All tools are equipped with integrated coolant supply
- Replaceable cut-off blade

Overview – multidec®-4000

Legend 4

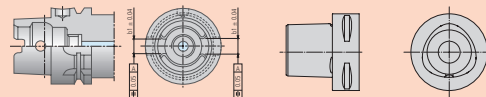

Technical information about HSK versions and PSC (Capto®) 6



Inserts 7

4002... EN GS PM1 7

4002... EN GS PM2 8

4002... EN GS SC1 9

4002... FN GS PA7 10

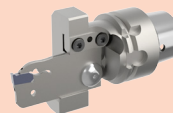

Holders 11

HSK-T40/A40 MT 4000 ... (OD turning) 11

PSC 40 MT 4000 ... (OD turning) 12

HSK E40 MT 4000 ... WM (OD turning for Willemin-Macodel machines) 13



Replacement and spare parts 14

Alpha 900	175-200	180-200	200-250	250-300
HSK version HSK version PSC HSK version PSC	HSK version HSK version PSC HSK version PSC	HSK version HSK version PSC HSK version PSC	HSK version HSK version PSC HSK version PSC	HSK version HSK version PSC HSK version PSC
Material Capto Capto	1 1 1	1 1 1	1 1 1	1 1 1
HSK version HSK version HSK version	1 1 1	1 1 1	1 1 1	1 1 1

Cutting specification 15

Different information about multidec® application refer to certain machining methods. In addition, simple symbols inform of the product assortment and where additional products and technical information can be found.

Dimensions

All dimensions are in millimeter (mm); native dimensions in inch are calculated into millimeter.

Page information

□ 12... See page 12 and the following (example)

Recommended usage

- Preferred application
- Possible application
- Application not recommended

Availability

- Standard articles
- Standard articles, new in this catalogue
- Discontinued articles

Categorization of materials

The information on using multidec® tools refers to certain materials.

The materials to be machined are categorized in the same color throughout the entire catalog:

Steel (non-alloyed, low alloyed and high alloyed)
Stainless steel
Titanium and Ti-alloys
Non-ferrous metals (gold, aluminum and brass)
Hard materials

Order designation

To the designation of the selected type of product, the desired cutting material code must be added.

Supplementing information to the grades can be found according to the page references (□ ...).

Order designation		Carbide □ 20		
		○	●	●
		○	●	●
		○	●	●
		●	○	—
		—	—	○
		UHM 20	UHM 20 HPX	UHM 20 TX+
L	R	■	■	■
1605-0.5-1.5 L ...	1605-0.5-1.5 R ...	■	■	■
1605-1.0-2.5 L ...	1605-1.0-2.5 R ...	■	■	■
1605-1.5-3 L ...	1605-1.5-3 R ...	■	■	■

Example: 1605-0.5-1.5 L UHM 20

Packaging information

The product labels illustrate the content of the packaging and also show the materials on which the cutting insert can be used. For this purpose, UTILIS uses the ISO standard coding.

The UTILIS article number is generally also printed as a barcode on the UTILIS (multidec®) product packaging.

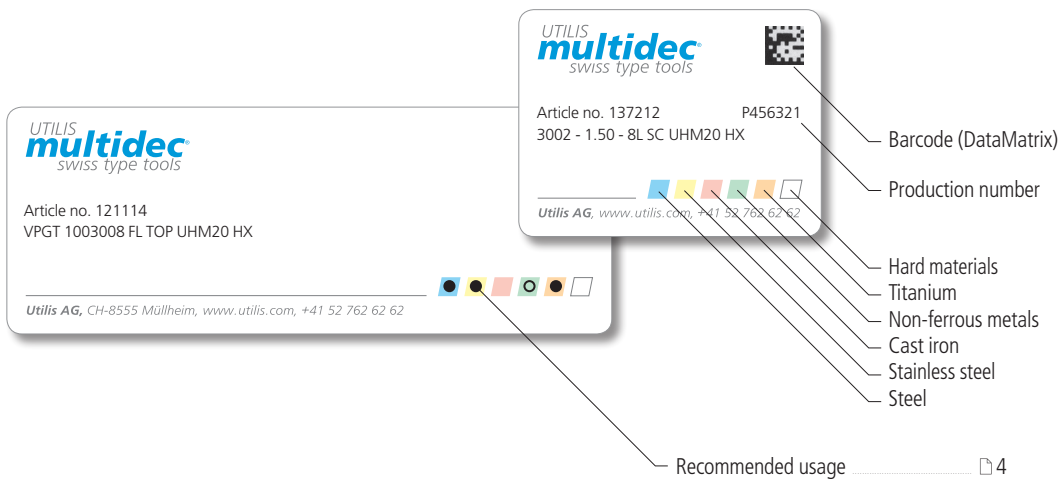

Execution of holder/insert

The side on which the insert is located determines whether it is a "left-" or "right-hand" holder. For this purpose, the holder is viewed with the insert pointing towards the observer.

Pictures

The right-hand version of the tools is usually shown. (Exceptions are possible). The tool colours illustrated here are not binding.

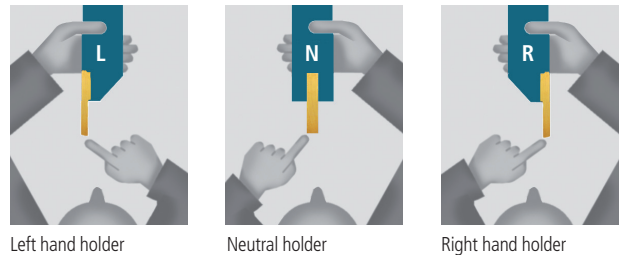

Product lines

To meet today's requirements of modern production it is not necessary to use the most accurate – but to use the tools adapted to the requirements. This means, the more accurate and sophisticated the process, the higher must be the accuracy of the produced tools. Therefore, the product range has been divided into three different accuracy classes. Your advantage: you buy the quality, which is effectively required.

Product line	Description
PREMIUM-LINE	The PREMIUM-LINE includes UTILIS tools with the highest accuracy requirements, especially for the production of micro parts. Tightest dimensional tolerances, precisely executed, highest surface quality and high repeatability are the features of this line. The manufacturing of these high-class tools requires considerable additional cost in production, which justifies the higher price of this product line.
STANDARD-LINE	The STANDARD-LINE meets the highest demands on the quality, which is demanded for Swiss type tools in production of small parts. Tight dimensional tolerances and high surface quality are implemented. These are quality standard tools, which are very well positioning this line in a wide range of applications.
VALUE-LINE	The VALUE-LINE is based on the known positions of our STANDARD-LINE. The most important functional elements – such as inserts and holders – are manufactured with the normal dimensional tolerances seen in the industry. Designed for the production of low-cost components, this line offers optimal quality standards. The greater tolerances and the reduced surface quality lower the production costs considerably, which also lowers the price in comparison to the standard product line.

Technical information about HSK versions and PSC (Capto®)

HSK versions (ISO 12164/DIN 69893)

HSK – Form A

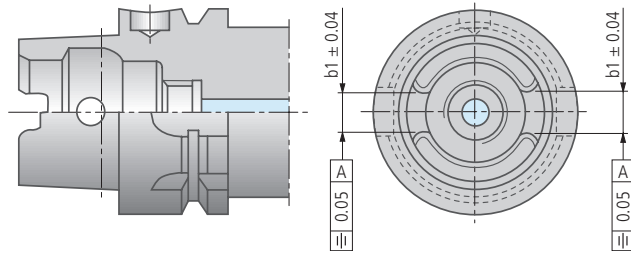

- Used on machining centers, milling machines, turning machines, special machines with automatic tool change
- Central, axial coolant supply through coolant tube
- Torque transmission via two key slots at end of taper
- Two slots on collar for tool magazine, location edge hole for data carrier in collar

HSK – Form T

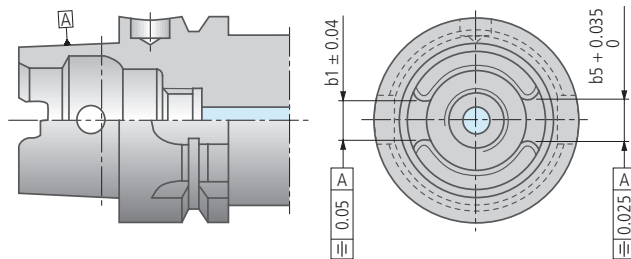

Tighter tolerance for perfect change precision

The "T" stands for "Turning". HSK-T combines the basic shape of the HSK taper in form A/C and differs by closer tolerances of the cam grooves on the cone of the tools. This important feature for turning assures accurate radial positioning (center height).

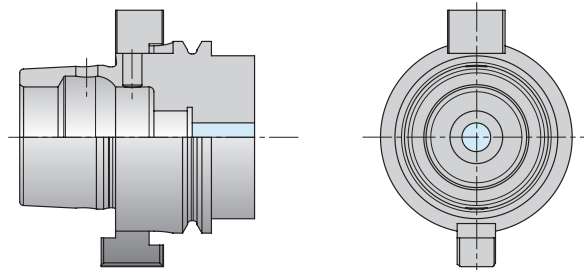

Version especially for Willemin-Macodel machines

- Torque transmission via two slot nuts.

PSC (ISO 26623)

PSC/Capto®

multidec®-PSC is a flexible and modular quick change toolholder-system, with a polygon-connection compliant with ISO 26623-1 standard. High torque transmission is one basic advantage of the system.

Size		Dimensions		
PSC	Sandvik Coromant Capto®	D	l ₁	l ₂
32	C3	32	19	15
40	C4	40	24	20
50	C5	50	30	20
63	C6	63	38	22
80	C8	80	48	30
100	C10	100	60	32

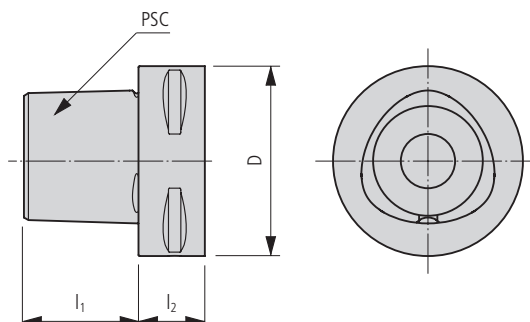



CUT off

PM1: For steel with high tensile strength

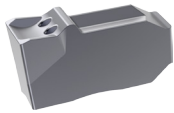

E: Insert with rounded cutting edge

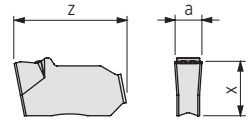

4002... EN GS PM1

Order designation	Carbide *						Dimensions						Holder
	-	○	●	●	○	●	a	x	z				11...
<div style="background-color: #0056b3; color: white; padding: 2px; text-align: center; width: 15px; margin: 0 auto;">N</div>	○	●	●	●	○	●							
	●	○	-	○	○	-							
	-	-	●	-	-	-							
	UHM 10	UHM 10HX	UHM 10TX+	UHM 20HPX	UHM 30HX	UHM 30MZ							
	VALUE-LINE												
	4002-3.0 EN GS PM1...				■	■	■	3	6	12			



Item 300362

* Can be found in general catalogue 2020 / 21

– Technical information 11–31

www.utilis.com



CUT off

PM2: All-round chip breaker for steel

8

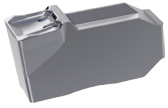

E: Insert with rounded cutting edge

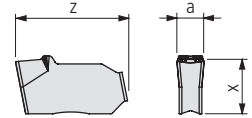

4002... EN GS PM2

Order designation	Carbide *						Dimensions						Holder
	-	○	●	●	○	●	a	x	z				□ 11...
<div style="border: 1px solid black; padding: 2px; display: inline-block;">N</div>	-	○	●	●	○	●							
	○	●	●	●	○	●							
	●	○	-	○	○	-							
	-	-	●	-	-	-							
	UHM 10	UHM 10HX	UHM 10TX+	UHM 20HPX	UHM 30HX	UHM 30MZ							
<div style="background-color: #444; color: white; padding: 5px; display: inline-block; transform: rotate(-2deg);">VALUE-LINE</div>													
4002-3.0 EN GS PM2...				■	■	■	3	6	12				...4000...



CUT off

SC1: Specially for stainless steel and super-alloys

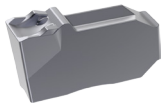

E: Insert with rounded cutting edge

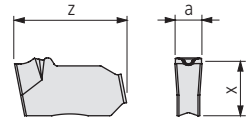

4002... EN GS SC1

Order designation	Carbide *						Dimensions						Holder
	-	○	●	●	○	●	a	x	z				11...
<div style="background-color: #0056b3; color: white; padding: 2px; display: inline-block;">N</div>	○	●	●	●	○	●							
	●	○	-	○	○	-							
	-	-	●	-	-	-							
	UHM 10	UHM 10HX	UHM 10TX+	UHM 20HPX	UHM 30HX	UHM 30MZ							
VALUE-LINE													
4002-3.0 EN GS SC1...				■	■	■	3	6	12				...4000...



Item 300362

* Can be found in general catalogue 2020 / 21

– Technical information 11–31

www.utilis.com



CUT off

PA7: First choice for non-ferrous metals

10

UTILIS
multidec
swiss type tools

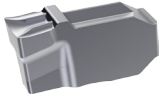

F: Insert with sharp cutting edge

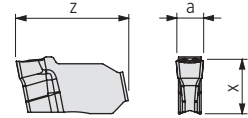

4002... FN GS PA7

Order designation	Carbide *						Dimensions						Holder	
	-	○	●	●	○	●	a	x	z				□ 11...	
N	-	○	●	●	○	●								
	○	○	●	●	○	●								
	●	○	-	○	○	-								
	-	-	●	-	-	-								
		UHM 10	UHM 10HX	UHM 10TX+	UHM 20HPX	UHM 30HX	UHM 30MZ							
STANDARD-LINE														
4002-3.0 FN GS PA7...	■	■	■				3	6	12				...4000...	



Item 300362

* Can be found in general catalogue 2020/21

– Technical information □ 11–31

www.utilis.com

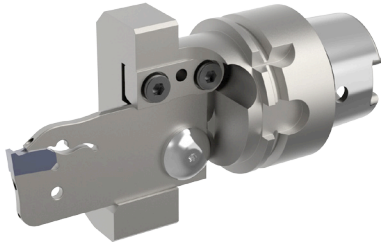

HSK – Form T
 HSK – Form A

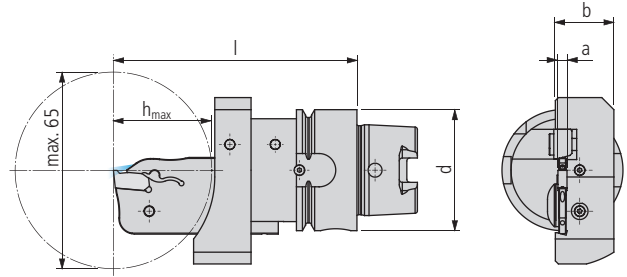

HSK-... MT 4000 ...

Order designation				Form / Size	Dimensions						Inserts
L		R		HSK	d	b	l	a	h _{max}		□ 7...
HSK-T40 MT 4000 26 L	■	HSK-T40 MT 4000 26 R	■	T40	40	19.5	80	3	32.5		40...
HSK-A40 MT 4000 26 L	■	HSK-A40 MT 4000 26 R	■	A40	40	19.5	80	3	32.5		40...

Scope of delivery: tool including cut off blade and assembly key



PSC / Capto®

12

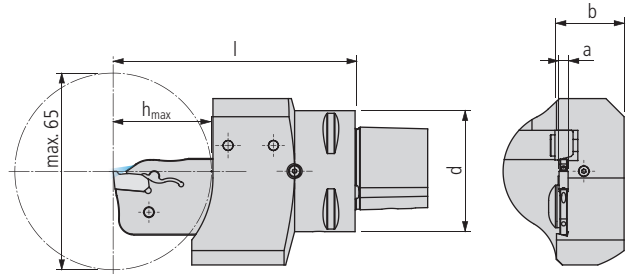
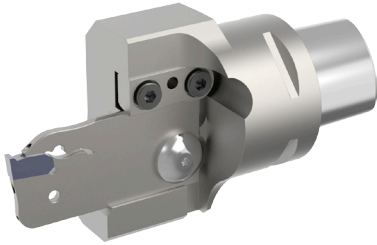

PSC 40 MT 4000 ...

Order designation		Form / Size	Dimensions					Inserts
L	R	PSC	d	b	l	a	h _{max}	7...
PSC 40 MT 4000 26 L	PSC 40 MT 4000 26 R	40	40	22.5	80	3	32.5	40...

Scope of delivery: tool including cut off blade and assembly key



HSK – Form E
(for Willemin-Macodel machines)

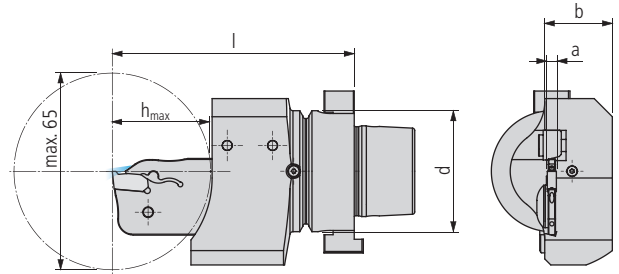
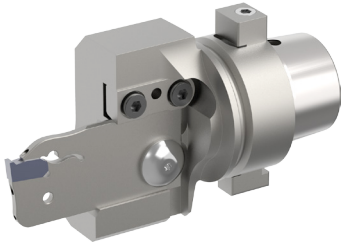

HSK E40 MT 4000 ... WM

Order designation		Form / Size	Dimensions					Inserts
L	R	HSK	d	b	l	a	h _{max}	7...
HSK-E40 MT 4000 26 L WM	HSK-E40 MT 4000 26 R WM	E40	40	22.5	80	3	32.5	40...

Scope of delivery: tool including cut off blade and assembly key

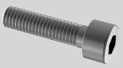
Illustration	Description	Dimensions	Order designation	Holder
	Cut-off blade including screw plug with seal ring		MSP 4000 26 GS-3 SK	■ ...4000 26..
	Screw plug with seal ring	M4	MSP 4000 M4 KVS	■ MSP 4000 26 GS-3 SK
	Installation wrench		MSP 4000 2-3 MS	■ MSP 4000 26 GS-3 SK
	Clamping shim for cut-off blade (right-hand holder)		MSP 4000 SK-R	■ ...4000 26 R
	Clamping shim for cut-off blade (left-hand holder)		MSP 4000 SK-L	■ ...4000 26 L
	Cylinder head screw	M4 x 12	MSP 40120 ZKS IB3	■ MSP 4000 SK-.
	Seal ring (O-ring)		MSP OR 8.00x1.50	■ ...4000 26..

CUT off*

Materials (category) Hardness value (HB) / (HRC)	Carbide	Cutting speeds v_c (m/min)		Feeds f (mm/rev)			
				▼ PM1	▼ PM2	▼ SC1	▼ PA7
Steel non-alloyed (I) 125–300 HB	UHM20 HPX	80–180		0.1–0.3	0.075–0.2	–	–
	UHM30 HX	80–150		0.1–0.3	0.075–0.2	–	–
	UHM30 MZ	110–190		0.1–0.3	0.075–0.2	–	–
Steel low alloyed (II) 180–250 HB	UHM20 HPX	60–150		0.1–0.3	0.075–0.2	–	–
	UHM30 HX	60–120		0.1–0.3	0.075–0.2	–	–
	UHM30 MZ	100–180		0.1–0.3	0.075–0.2	–	–
Steel high alloyed (III) 200–350 HB	UHM20 HPX	50–120		0.1–0.3	0.075–0.2	–	–
	UHM30 HX	50–100		0.1–0.3	0.075–0.2	–	–
	UHM30 MZ	70–160		0.1–0.3	0.075–0.2	–	–
Stainless steel (V) 180–220 HB	UHM20 HPX	50–180		0.1–0.3	0.075–0.2	0.075–0.18	0.05–0.1
	UHM30 HX	50–150		0.1–0.3	0.075–0.2	0.075–0.18	0.05–0.1
	UHM30 MZ	90–170		0.1–0.3	0.075–0.2	0.075–0.18	0.05–0.1
Stainless steel (VI) 220–330 HB	UHM20 HPX	60–90		0.1–0.3	0.075–0.2	0.075–0.18	0.05–0.1
	UHM30 HX	50–80		0.1–0.3	0.075–0.2	0.075–0.18	0.05–0.1
	UHM30 MZ	60–90		0.1–0.3	0.075–0.2	0.075–0.18	0.05–0.1
Titanium (IV) –	UHM20 HPX	50–120		–	–	0.075–0.18	0.05–0.1
	UHM30 HX	20–60		–	–	0.075–0.18	0.05–0.1
	UHM30 MZ	–		–	–	–	–
Aluminum (VII) 60–130 HB	UHM10	200–2000		–	–	–	0.05–0.25
	UHM10 HX	200–2000		–	–	–	0.05–0.25
	UHM10 TX+	200–2000		–	–	–	0.05–0.25
Brass / lead-free brass (VIII) –	UHM10	200–600		–	–	–	0.05–0.25
	UHM10 HX	200–600		–	–	–	0.05–0.25
	UHM10 TX+	200–600		–	–	–	0.05–0.25
Synthetics reinforced/composites (IX) –	UHM10	–		–	–	–	–
	UHM10 HX	–		–	–	–	–
	UHM10 TX+	15–50		–	–	–	0.05–0.25
Hard materials (X) 45–70 HRC	UHM 20 HPX	–		–	–	–	–
	UHM 20 HX	–		–	–	–	–
	UHM 20 TX+	15–80		–	–	–	0.03–0.15

* Reduce the feed rate by 20 % when feeding in until the insert fully engages and when moving out the final 0.3 mm.

Note

- In order to achieve good results, oil cooling is recommended, preferably at high pressure, with approx. 60 bar. Too much pressure can have a negative influence on chip formation.
- With stable conditions, the use of holders with integrated cooling "IC" and optimum cooling can generally increase the cutting data by up to 30 %.



■ **Utilis AG, Precision Tools**

Kreuzlingerstrasse 22, CH-8555 Müllheim, Switzerland
Phone +41 52 762 62 62, Fax +41 52 762 62 00
info@utilis.com, www.utilis.com